

2024

# K5

Owner's Manual

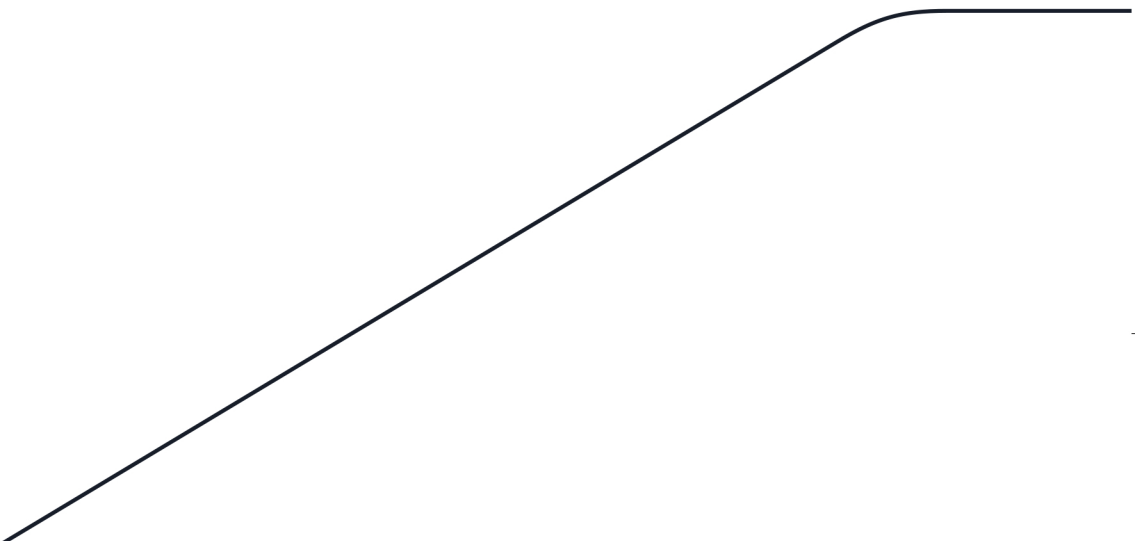

Movement that inspires



**WARNING – California  
Proposition 65**

“Operating, servicing and maintaining a passenger vehicle or off-road vehicle can expose you to chemicals including engine exhaust, carbon monoxide, phthalates, and lead, which are known to the State of California to cause cancer and birth defects or other reproductive harm. To minimize exposure, avoid breathing exhaust, do not idle the engine except as necessary, service your vehicle in a well-ventilated area and wear gloves or wash your hands frequently when servicing your vehicle. For more information go to [www.P65Warnings.ca.gov/passenger-vehicle](http://www.P65Warnings.ca.gov/passenger-vehicle).”

# FOREWORD

Dear Customer,

Thank you for selecting your new Kia vehicle.

As a global car manufacturer focused on building high-quality vehicles with exceptional value, Kia is dedicated to providing you with a customer service experience that exceeds your expectations.

This Owner's Manual is valid for all variants of your model, and describes all options, features, and equipment available, along with the maintenance needs. Therefore, this manual may also describe optional equipment not purchased on your vehicle, country specifications, and functions and features not available in your region. Please always keep this manual in the vehicle for your and any subsequent owner's reference.

Authorized Kia Dealerships provide factory-trained technicians, utilized recommended special service tools, and supply genuine Kia replacement parts to help you maintain and service your vehicle during your ownership.

All information contained in this Owner's Manual was accurate at the time of publication. However, as Kia continues to make improvements to its products, the company reserves the right to make changes to this manual or any of its vehicles at any time without notice and without incurring any obligations.

Please drive safely, and enjoy your Kia vehicle!

© 2023 Kia America, Inc.

All rights reserved. May not be reproduced or translated in whole or in part without the written consent of Kia America, Inc.

Printed in U.S.A.

## How to use this manual

We want to help you get the greatest possible driving pleasure from your vehicle. Your Owner's Manual can assist you in many ways.

We strongly recommend that you read the entire manual. In order to minimize the chance of death or injury, you must read the WARNING and CAUTION sections in the manual.

Illustrations complement the words in this manual to best explain how to enjoy your vehicle. By reading your manual, you learn about features, important safety information, and driving tips under various road conditions.

The general layout of the manual is provided in the Table of Contents. Use the index when looking for a specific area or subject, it has an alphabetical listing of all information in your manual.

Chapters: This manual has eight chapters plus an index. Each chapter begins with a brief list of contents so you can tell at a glance if that chapter has the information you want.

You will find various WARNINGS, CAUTIONS and NOTICES in this manual. These WARNINGS were prepared to enhance your personal safety. You should carefully read and follow ALL procedures and recommendations provided in these WARNINGS, CAUTIONS and NOTICES.

### **WARNING**

A WARNING indicates a situation in which harm, serious bodily injury or death could result if the warning is ignored.

---

### **CAUTION**

A CAUTION indicates a situation in which damage to your vehicle could result if the caution is ignored.

---

### **NOTICE**

A NOTICE indicates interesting or helpful information is being provided.

---



# Table of Contents

Introduction	①
Your vehicle at a glance	②
Safety features of your vehicle	③
Features of your vehicle	④
Driving your vehicle	⑤
Driver assistance system	⑥
What to do in an emergency	⑦
Maintenance	⑧
Specifications, Consumer information and Reporting safety defects	⑨
Abbreviation	Ⓐ
Index	Ⓘ

Fuel requirements .....	1-2
Vehicle modifications.....	1-4
Vehicle break-in process .....	1-4
Risk of burns when parking or stopping vehicle .....	1-5
Vehicle data collection and Event Data Recorders.....	1-5

## Introduction

### Fuel requirements

Your new vehicle is designed to use only unleaded fuel having a pump octane number  $((R+M)/2)$  of 87 (Research Octane Number 91) or higher. (Do not use methanol blended fuels.)

Your new vehicle is designed to obtain maximum performance with UNLEADED FUEL, as well as minimize exhaust emissions and spark plug fouling.

Never add any fuel system cleaning agents to the fuel tank other than what has been specified. (Consult an authorized Kia dealer for details.)

- Tighten the cap until it clicks one time, otherwise the 'Check Engine'  light will appear.

### **⚠ WARNING**

#### Refueling

- Do not "top off" after the nozzle automatically shuts off. Attempts to force more fuel into the tank can cause fuel overflow onto you and the ground, causing a risk of fire.
- Always check that the fuel cap is installed securely to prevent fuel spillage, especially in the event of an accident.

### Gasoline containing alcohol and methanol

Gasohol, a mixture of gasoline and ethanol (also known as grain alcohol), and gasoline or gasohol containing methanol (also known as wood alcohol) are being marketed along with or instead of leaded or unleaded gasoline.

Pursuant to Environmental Protection Agency (EPA) regulations, ethanol may be used in your vehicle.

Do not use gasohol containing more than 15% ethanol, and do not use gasoline or gasohol containing any methanol. Ethanol provides less energy than gasoline and attracts water. Thus, it is likely to reduce your fuel efficiency and could lower your MPG results.

Methanol may cause drivability problems and damage to the fuel system, engine control system and emission control system.

Discontinue using gasohol of any kind if drivability problems occur.

Vehicle damage or drivability problems may not be covered by the manufacturer's warranty if they result from the use of:

1. Gasoline or gasohol containing methanol.
2. Leaded fuel or leaded gasohol.
3. Gasohol containing more than 15% ethanol.

"E85" fuel is an alternative fuel comprised of 85% ethanol and 15% gasoline, and is manufactured exclusively for use in Flexible Fuel Vehicles. "E85" is not compatible with your vehicle. Use of "E85" may result in poor engine performance and damage to your vehicle's engine and fuel system. Kia recommends that customers do not use fuel with an ethanol content exceeding 15%.

### **\* NOTICE**

Your New Vehicle Limited Warranty does not cover damage to the fuel system or any performance problems caused by the use of "E85" fuel.

**\* NOTICE**

Never use any fuel containing methanol. Discontinue use of any methanol containing products which may inhibit proper drivability.

**Other fuels**

Using fuels that contain Silicone (Si), MMT (Manganese, Mn), Ferrocene (Fe), and Other metallic additives, may cause vehicle and engine damage or cause misfiring, poor acceleration, engine stalling, catalyst melting, clogging, abnormal corrosion, life cycle reduction, etc.

Also, the Malfunction Indicator Lamp (MIL) may appear.

**\* NOTICE**

Damage to the fuel system or performance problems caused by the use of these other fuels may not be covered by your New Vehicle Limited Warranty.

**Gasoline containing MMT**

Some gasoline contains harmful manganese-based fuel additives such as MMT (Methylcyclopentadienyl Manganese Tricarbonyl). Kia does not recommend the use of gasoline containing MMT. This type of fuel can reduce vehicle performance and affect your emission control system. The Malfunction Indicator Lamp (MIL) on the cluster may come on.

**Do not use methanol**

Fuels containing methanol (wood alcohol) should not be used in your vehicle. This type of fuel can reduce vehicle performance and damage components of

the fuel system, engine control system and emission control system.

**Fuel Additives**

Kia recommends that you use good quality gasolines treated with detergent additives such as TOP TIER Detergent Gasoline, which help prevent deposit formation in the engine. These gasolines will help the engine run cleaner and enhance performance of the emission control system.

For more information on TOP TIER Detergent Gasoline, please go to the website ([www.toptiergas.com](http://www.toptiergas.com)) For customers who do not use TOP TIER Detergent Gasoline regularly, and have problems starting or the engine does not run smoothly, additives that you can buy separately may be added to the gasoline.

If TOP TIER Detergent Gasoline is not available, one bottle of additive should be added to the fuel tank at every 8,000 miles (13,000 km) or every engine oil change is recommended. Additives are available from your authorized Kia dealer along with information on how to use them. Do not mix other additives.

**Operation in foreign countries**

If you are going to drive your vehicle in another country, be sure to:

- Observe all regulations regarding registration and insurance.
- Determine that acceptable fuel is available.

## Vehicle modifications

This vehicle should not be modified. Modification of your vehicle could affect its performance, safety or durability and may even violate governmental safety and emissions regulations.

### \* NOTICE

Damage or performance problems resulting from any modification may not be covered under warranty.

### ⚠ CAUTION

If you use unauthorized electronic devices, it may cause the vehicle to operate abnormally, wire damage, battery discharge and fire.

For your safety, do not use unauthorized electronic devices.

## Vehicle break-in process

By following a few simple precautions for the first 600 miles (1,000 km) you may add to the performance, economy and life of your vehicle.

- Do not race the engine.
- While driving, keep your engine speed (rpm, or revolutions per minute) between 2,000 rpm and 4,000 rpm.
- Do not maintain a single engine speed for long periods of time, either fast or slow. Varying engine speeds is needed to properly break-in the engine.
- Avoid hard stops, except in emergencies, to allow the brakes to seat properly.
- Don't tow a trailer during the first 1,200 miles (2,000 km) of operation.
- Fuel economy and engine performance may vary depending on vehicle break-in process and be stabilized after 4,000 miles (6,000 km). New engines may consume more oil during the vehicle break-in period.

## Risk of burns when parking or stopping vehicle

- Do not park or stop the vehicle near flammable items such as leaves, paper, oil, and tire. Such items placed near the exhaust system can become a fire hazard.
- When an engine idles at a high rpm with the rear side of the vehicle in close proximity of the wall, heat of the exhaust gas can cause discoloration or fire. Keep enough space between the rear part of the vehicle and the wall.
- Be sure not to touch the exhaust/catalytic systems while engine is running or right after the engine is turned off. There is a risk of burns since the systems are extremely hot.

## Vehicle data collection and Event Data Recorders

This vehicle is equipped with an event data recorder (EDR). The main purpose of an EDR is to record, in certain crash or near crash-like situations, such as an air bag deployment or hitting a road obstacle, data that will assist in understanding how a vehicle's systems performed. The EDR is designed to record data related to vehicle dynamics and safety systems for a short period of time, typically 30 seconds or less. The EDR in this vehicle is designed to record such data as:

- How various systems in your vehicle were operating;
- Whether or not the driver and passenger safety belts were buckled/fastened;
- How far (if at all) the driver was depressing the accelerator and/or brake pedal; and,
- How fast the vehicle was traveling.

These data can help provide a better understanding of the circumstances in which crashes and injuries occur.

**NOTE:** EDR data are recorded by your vehicle only if a non-trivial crash situation occurs; no data are recorded by the EDR under normal driving conditions and no personal data (e.g., name, gender, age, and crash location) are recorded. However, other parties, such as law enforcement, could combine the EDR data with the type of personally identifying data routinely acquired during a crash investigation.

To read data recorded by an EDR, special equipment is required, and access to the vehicle or the EDR is needed. In addition to the vehicle

manufacturer, other parties, such as law enforcement, that have the special equipment, can read the information if they have access to the vehicle or the EDR.

Exterior overview .....	2-2
Interior overview .....	2-4
Instrument panel overview .....	2-6
Engine compartment.....	2-8



# Your vehicle at a glance

## Exterior overview

Front view



ODL3A013001

\* The actual shape may differ from the illustration.

- |  |                  |
|--|------------------|
| 1. Hood                                      | 4-36             |
| 2. Head lamp                                 | 4-95, 8-59       |
| 3. Wheel and tire                            | 8-33, 9-8        |
| 4. Outside rear view mirror                  | 4-60             |
| 5. Panoramic sunroof                         | 4-42             |
| 6. Front windshield wiper blades             | 4-102, 8-29      |
| 7. Windows                                   | 4-32             |
| 8. Front radar                               | 6-16, 6-68, 6-95 |
| 9. Front fog lamp (Features of your vehicle) | 4-95, 8-62       |
| 10. Front ultrasonic sensors                 | 6-114            |
| 11. Front view camera                        | 6-4              |

Rear view



2

ODL3A011002

\* The actual shape may differ from the illustration.

- |                            |              |
|----------------------------|--------------|
| 1. Door locks              | 4-16         |
| 2. Fuel filler door        | 4-38         |
| 3. Rear combination lamp   | 8-63, 8-64   |
| 4. High mounted stop lamp  | 8-64         |
| 5. Trunk                   | 4-26         |
| 6. Antenna                 | 4-135        |
| 7. Wide-rear view camera   | 6-101, 6-105 |
| 8. Rear ultrasonic sensors | 6-110, 6-114 |

## Interior overview

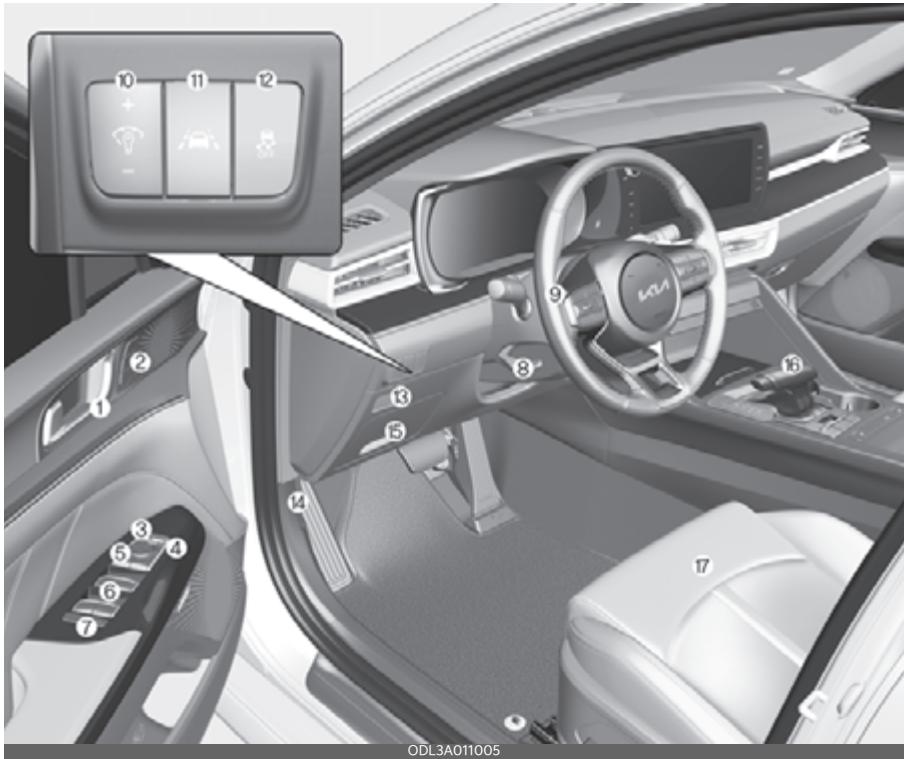

\* The actual shape may differ from the illustration.

- |  |      |
|--|------|
| 1. Inside door handle                            | 4-18 |
| 2. Seat position memory system                   | 4-24 |
| 3. Outside rearview mirror folding button        | 4-61 |
| 4. Outside rearview mirror control switch        | 4-60 |
| 5. Central door lock/unlock button               | 4-19 |
| 6. Power window switches                         | 4-32 |
| 7. Power window lock button                      | 4-35 |
| Electronic power child safety lock button        | 4-21 |
| 8. Steering wheel tilt/telescopic lever          | 4-47 |
| 9. Steering wheel                                | 4-46 |
| 10. Instrument panel illumination control switch | 4-64 |
| 11. Lane Safety button                           | 6-31 |
| 12. ESC OFF button                               | 5-37 |

**Your vehicle at a glance**

**Interior overview**

- 13.Trunk release button
- 14.Hood release lever
- 15.Instrument panel fuse
- 16.Shift lever
- 17.Seat

- 4-26
- 4-36
- 8-47
- 5-8, 5-14
- 3-5

## Instrument panel overview



ODL3A012004

\* The actual shape may differ from the illustration.

- |  |              |
|--|--------------|
| 1. Audio remote control button Refer to "Car Infotainment System Quick Reference Guide". |              |
| 2. Driver's front air bag  | 3-34         |
| 3. Horn  | 4-48         |
| 4. Driving Assist button   | 6-68, 6-95   |
| 5. Instrument cluster  | 4-63         |
| 6. Light control/Turn signals lever  | 4-95         |
| 7. Wiper and washer control lever  | 4-102        |
| 8. ENGINE START/STOP button  | 5-5          |
| 9. Infotainment system Refer to "Car Infotainment System Quick Reference Guide".         |              |
| 10. Hazard warning flasher   | 7-2          |
| 11. Climate control system   | 4-111        |
| 12. Front seat warmer and air ventilation seat switch                                    | 4-126, 4-128 |
| 13. Steering wheel heater button   | 4-47         |

14.Drive mode integrated control system dial	5-44
15.Parking Safety button	6-114
16.Auto Hold button	5-33
17.EPB switch	5-25
18.Parking/View button	6-101, 6-105
19.Wireless charging system	4-131
20.Passenger's air bag	3-34
21.Glove box	4-124
22.Shift lever	5-8, 5-14
23.Center console storage box	4-124
24.USB charger	4-129

## Engine compartment

Smartstream G1.6 T-GDi

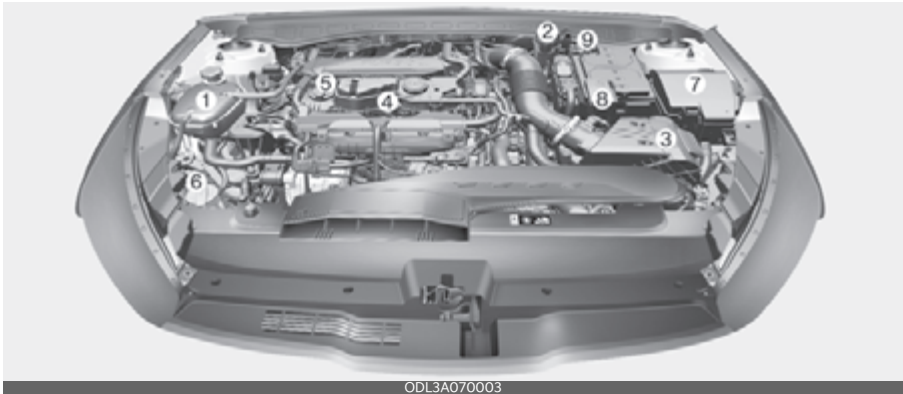

Smartstream G2.5 T-GDi

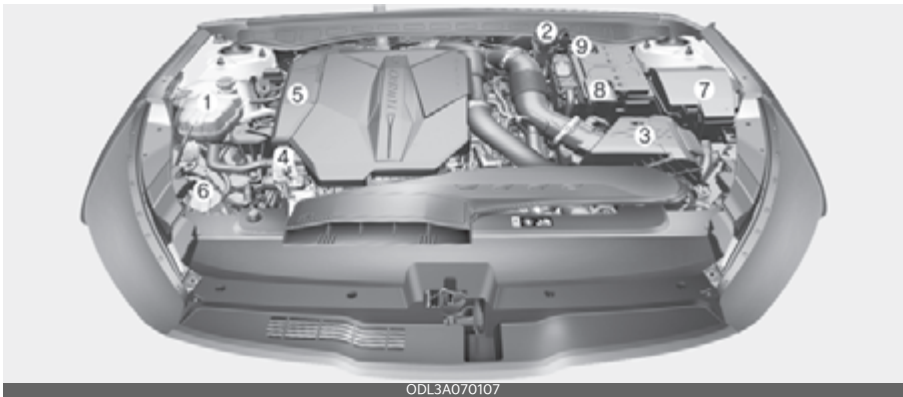

\* The actual engine room in the vehicle may differ from the illustration.

- |                                      |      |
|--------------------------------------|------|
| 1. Engine coolant reservoir          | 8-21 |
| 2. Brake fluid reservoir             | 8-24 |
| 3. Air cleaner                       | 8-26 |
| 4. Engine oil dipstick               | 8-18 |
| 5. Engine oil filler cap             | 8-18 |
| 6. Windshield washer fluid reservoir | 8-25 |
| 7. Fuse box                          | 8-47 |
| 8. Positive battery terminal         | 8-31 |
| 9. Negative battery terminal         | 8-31 |

<b>Important safety precautions .....</b>	<b>3-3</b>
<b>Seat.....</b>	<b>3-5</b>
• Feature of Seat Leather.....	3-7
• Front seat adjustment for manual seat.....	3-8
• Front seat adjustment for power seat .....	3-9
• Headrest for front seat .....	3-10
• Seatback pocket .....	3-13
• Rear seat adjustment .....	3-13
<b>Seat belts .....</b>	<b>3-17</b>
• Seat belt restraint system.....	3-17
• Seat belt warning .....	3-18
• Seat belt - Driver's 3-point system with emergency locking retractor .....	3-18
• Seat belts - Front passenger and rear seat 3-point system with combination locking retractor.....	3-20
• Pre-tensioner seat belt .....	3-22
• Seat belt precautions.....	3-23
• Care of seat belts .....	3-25
<b>Child Restraint System (CRS).....</b>	<b>3-26</b>
• Children always in the rear.....	3-26
• Selecting a Child Restraint System (CRS) .....	3-27
• Installing a Child Restraint System (CRS).....	3-29
<b>Air bag - Advanced Supplemental Restraint System .....</b>	<b>3-34</b>
• How does the air bag system operate?.....	3-35
• Air bag warning light .....	3-37
• Supplemental Restraint System (SRS) components and functions.....	3-37
• Occupant Detection System (ODS).....	3-40
• Driver's and passenger's front air bag.....	3-45
• Side air bag .....	3-48
• Curtain air bag.....	3-49



# 3 Safety features of your vehicle

- Air bag collision sensors .....3-51
- Why didn't my air bag go off in a collision?  
(Inflation and non-inflation conditions of the air bag)..... 3-52
- Supplemental Restraint System (SRS) care ..... 3-55
- Additional safety precautions..... 3-55
- Adding equipment to or modifying your air bag-equipped  
vehicle..... 3-57
- Air bag warning label ..... 3-57

## Safety features of your vehicle

For the safety of the driver and vehicle passengers, you should become familiar with the vehicle's safety features.

### Important safety precautions

You will find many safety precautions and recommendations throughout this section, and throughout this manual.

The safety precautions in this section are among the most important.

### Always wear your seat belt

A seat belt is your best protection in all types of accidents. Air bags are designed to supplement seat belts, not replace them. So even though your vehicle is equipped with air bags, ALWAYS make sure you and your passengers wear your seat belts, and wear them properly.

### Restrain all children

All children under age 13 should ride in your vehicle properly restrained in a rear seat, not the front seat. Infants and small children should be restrained in an appropriate child restraint. Larger children should use a booster seat with the lap/shoulder belt until they can use the seat belt properly without a booster seat. Please refer to your State or Federal laws for child seating requirements in the operation of a motor vehicle.

### Air bag hazards

While air bags can save lives, they can also cause serious or fatal injuries to occupants who sit too close to them, or who are not properly restrained. Infants, young children, and shorter adults are at

the greatest risk of being injured by an inflating air bag. Follow all instructions and warnings in this manual.

### Driver distraction

Driver distraction presents a serious and potentially deadly danger, especially for inexperienced drivers. Safety should be the first concern when behind the wheel and drivers need to be aware of the wide array of potential distractions, such as drowsiness, reaching for objects, eating, personal grooming, other passengers, and using cellular phones.

Drivers can become distracted when they take their eyes and attention off the road or their hands off the wheel to focus on activities other than driving. To reduce your risk of distraction or getting into an accident:

- ALWAYS set up your mobile devices (i.e., MP3 players, phones, navigation units, etc.) when your vehicle is parked or safely stopped.
- ONLY use your mobile device when allowed by laws and when conditions permit safe use. NEVER text or email while driving. Most states have laws prohibiting drivers from texting. Some states and cities also prohibit drivers from using handheld phones.
- NEVER let the use of a mobile device distract you from driving. You have a responsibility to your passengers and others on the road to always drive safely, with your hands on the wheel as well as your eyes and attention on the road.

## **Control your speed**

Excessive speed is a major factor in crash injuries and deaths. Generally, the higher the speed, the greater the risk, but serious injuries can also occur at lower speeds. Never drive faster than is safe for current driving conditions, regardless of the maximum speed posted.

## **Keep your vehicle in safe condition**

Having a tire blowout or a mechanical failure can be extremely hazardous. To reduce the possibility of such problems, check your tire pressures and conditions frequently, and perform all regularly scheduled maintenance.

## Seat

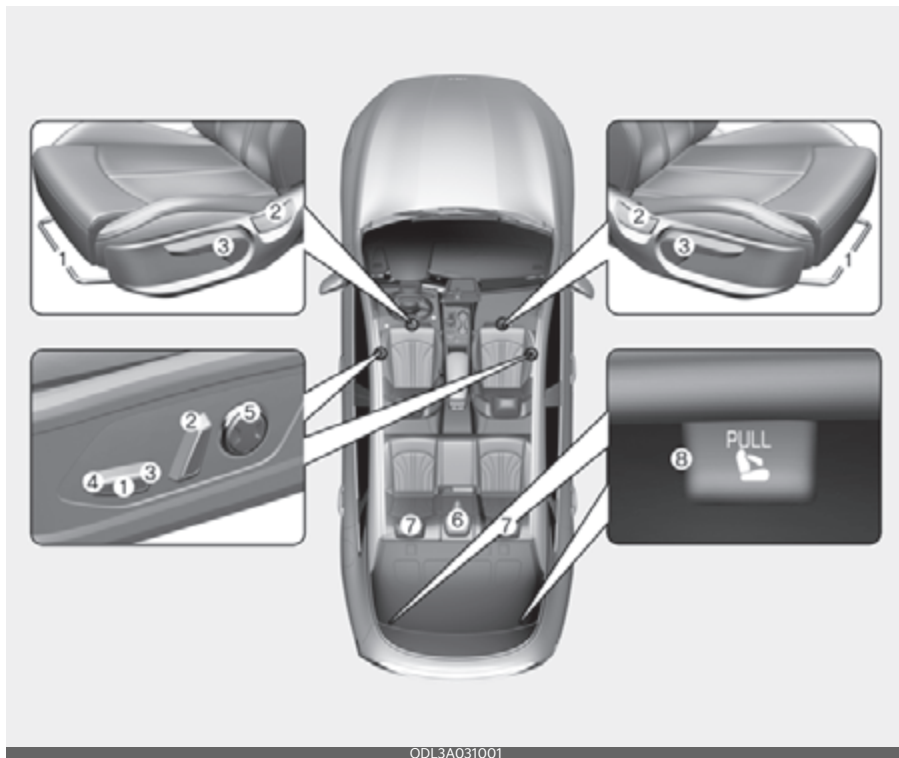

ODL3A031001

\* The actual feature in the vehicle may differ from the illustration.

### Driver's seat

1. Forward and backward
2. Seatback angle
3. Seat cushion height
4. Seat cushion tilt
5. Lumbar support

### Front passenger's seat

1. Forward and backward
2. Seatback angle
3. Seat cushion height
4. Seat cushion tilt
5. Lumbar support

### Rear seats

6. Armrest
7. Headrest
8. Seatback folding

**⚠ WARNING****Loose objects**

Loose objects in the driver's foot area could interfere with the operation of the foot pedals, possibly causing an accident. Do not place anything under the front seats.

**⚠ WARNING****Uprighting seat**

Do not press the release lever on a manual seatback without holding and controlling the seatback. The seatback will spring upright, possibly impacting you or other passengers.

**⚠ WARNING****Driver responsibility for passengers**

The driver must advise the passengers to keep the seatback in an upright position whenever the vehicle is in motion. If a seat is reclined during an accident, the restraint system's ability to restrain the passenger will be greatly reduced.

**⚠ WARNING****Seat cushion**

Occupants should never sit on aftermarket seat cushions or sitting cushions. The

passenger Occupant Detection System may not operate properly, or the passenger's hips may slide under the lap portion of the seat belt during an accident or a sudden stop.

**⚠ WARNING****Driver's seat**

- Never attempt to adjust the seat while the vehicle is moving. This could result in loss of control of your vehicle.
- Do not allow anything to interfere with the normal position of the seatback. For example, storing items against the seatback could result in serious or fatal injury in a sudden stop or collision.
- Sit as far back as possible from the steering wheel while still maintaining comfortable control of your vehicle. A distance of at least 10 inches (25 cm) from your chest to the steering wheel is recommended. Failure to do so can result in air bag inflation injuries to the driver.

**⚠ WARNING****Rear seatbacks**

Always lock the rear seatback before driving. Failure to do so could result in passengers or objects being thrown forward, injuring vehicle occupants.

**⚠ WARNING****Unexpected seat movement**

After adjusting a manual seat, always check that it is locked by shifting your weight to the front and to the back. Sudden or unexpected movement of the driver's seat could cause you to lose control of the vehicle.

**⚠ WARNING****Seat adjustment**

- Do not adjust the seat while wearing seat belts. Moving the seat forward will cause strong pressure on the abdomen.
- Do not place your hand near the seat bottom or seat track while adjusting the seat. Your hand could get caught in the seat mechanism.

**⚠ WARNING****Luggage and cargo**

Do not stack/pile luggage or cargo higher than the seatback in the cargo area. In an accident the cargo could strike and injure a passenger. If objects are large, heavy or must be piled, they must be secured in the cargo area.

**⚠ WARNING****Cargo area**

Do not allow passengers to ride in the cargo area under any circumstance. The cargo area is solely for the purpose of transporting luggage or cargo.

**⚠ WARNING****Small objects**

Use extreme caution when picking up small objects trapped under the seats or between the seat and the center console. Your hands might be cut or injured by the sharp edges of the seats mechanism.

**⚠ CAUTION****Precautions with seat covers**

Use caution when working on the seat cover. A short circuit or disconnection

may occur, which could lead to an abnormal noise or damage the ventilation system.

**⚠ WARNING****Seat short circuit risk**

Be aware of wires or air vents when placing a seat cover or covering the seat with plastic cover. A short circuit may occur, which could lead to fire.

**Feature of Seat Leather (if equipped)**

- Our car seats are upholstered with a combination of artificial and genuine leather. The genuine leather is made from the outer skin of an animal, which goes through a special process to be available for use. Since it is a natural substance, each part differs in thickness or density. Also, wrinkles could appear depending on the temperature and humidity.
- The seat cover is made of stretchable material to improve comfort of passengers.
- The parts contacting the body are curved and the side supporting area is high which provides driving comfort and stability.

**⚠ CAUTION**

- Belts with metallic accessories, zippers or keys inside the back pocket may damage the seat fabric.
- Make sure not to wet the seat. It may change the nature of leather.
- Jeans or clothes which could bleach may contaminate the surface of the seat covering fabric.

## \* NOTICE

Wrinkles or abrasions may appear naturally from usage. It is not a fault of product. Wrinkles or abrasions are not covered by warranty.

### Front seat adjustment for manual seat

The front seat can be adjusted by using the control levers located on the outside of the seat cushion.

#### Moving forward and backward

Adjust the seat before driving, and make sure the seat is locked securely by trying to move forward and backward without using the lever. If the seat moves, it is not locked properly.



To move the seat forward or backward:

1. Pull the seat slide adjustment lever up and hold it.
2. Slide the seat to the position you desire.
3. Release the lever and make sure the seat is locked in place.

### Reclining seatback

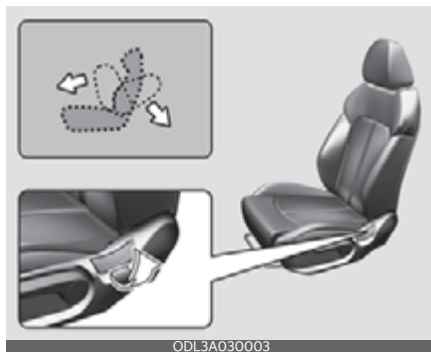

To recline the seatback:

1. Lean forward slightly and lift up the seatback recline lever.
2. Carefully lean back on the seat and adjust the seatback of the seat to the position you desire.
3. Release the lever and make sure the seatback is locked in place. (The lever **MUST** return to its original position for the seatback to lock.)

## ⚠ WARNING

### Reclining seatback

Sitting in a reclined position when the vehicle is in motion can be dangerous. Even when buckled up, the protections of your restraint system (seat belts and/or air bags) is greatly reduced by reclining your seatback.

Seat belts must be snug against your hips and chest to work properly. When the seatback is reclined, the shoulder belt cannot do its job because it will not be snug against your chest. Instead, it will be in front of you. During an accident, you could be thrown into the seat belt, causing neck or other injuries.

The more the seatback is reclined, the greater chance the passenger's hips will slide under the lap belt or the passenger's neck will strike the shoulder belt.

### Changing seat cushion height

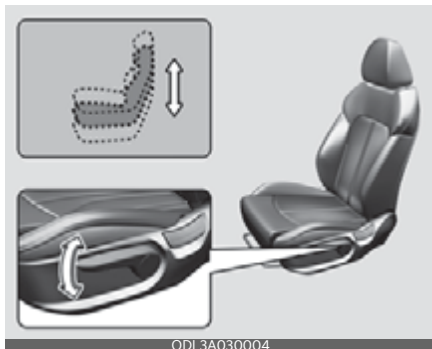

To change the height of the seat cushion, push the lever upwards or downwards.

- To lower the seat cushion, push down the lever several times.
- To raise the seat cushion, pull up the lever several times.

### Front seat adjustment for power seat (if equipped)

The front seat can be adjusted by using the control switches located on the outside of the seat cushion.

Before driving, adjust the seat to the proper position so you can easily control the steering wheel, pedals and switches on the instrument panel.

### ⚠ WARNING

#### Unattended children

Never leave children unattended in a vehicle. Children might operate features of the vehicle that could injure them.

### ⚠ CAUTION

#### Power seating adjustments

- The power seating controls function by electronic motor. Excessive operation may cause damage to the electrical equipment.
- Do not operate two or more power seat control switches at the same time. Doing so may damage the power seat motor or electrical components.

### Moving forward and backward



To move the seat forward or backward:

1. Push the control switch forward or backward to move the seat to the desired position.
2. Release the switch once the seat reaches the desired position.



### Reclining seatback



To recline the seatback:

1. Push the control switch forward or backward to move the seatback to the desired angle
2. Release the switch once the seat reaches the desired position.

### Changing seat cushion tilt and height

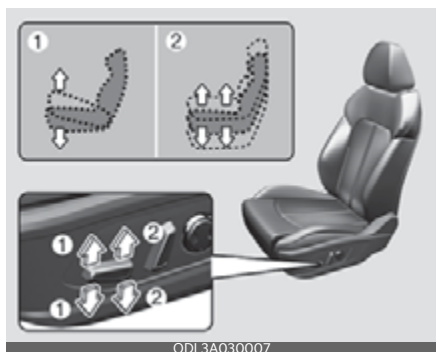

To change the tilt and height of the seat:

1. Pull the front portion (1) of the control switch up to raise or press down to lower the front part of the seat cushion.
2. Pull the rear portion (2) of the control switch up to raise or press down to lower the back part of the seat cushion.

3. Release the switch once the seat reaches the desired position.

### Adjusting lumbar support (if equipped)



The lumbar support can be adjusted by pressing the lumbar support switch on the side of the seat.

1. Press the front portion of the switch to increase support, or the rear portion of the switch, to decrease support.
2. Release the switch once it reaches the desired position.

### Headrest for front seat

The driver's and front passenger's seats are equipped with a headrest for the occupant's safety and comfort.



The headrest not only provides comfort for the driver and front passenger, but

also helps protect the head and neck in the event of a rear collision.

For maximum effectiveness in case of an accident, the headrest should be adjusted so the middle of the headrest is as high as the center of gravity of an occupant's head. Generally, the center of gravity of most people's head is similar with the height of the top of their eyes.

Also, adjust the headrest as close to your head as possible. For this reason, the use of a cushion that holds the body away from the seatback is not recommended.

**⚠ WARNING**

**Headrest removal/adjustment**

- Do not operate the vehicle with the headrests removed. Headrests can provide critical neck and head support in a crash.
- Do not adjust the headrest height while the vehicle is in motion. Driver may lose control of the vehicle.

**⚠ CAUTION**

Excessive pulling or pushing may damage the headrest.

**Adjusting the height up and down**

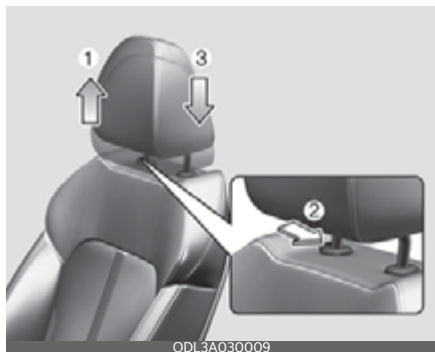

To raise the headrest:

1. Pull it up to the desired position (1).
2. To lower the headrest, push and hold the release button (2) on the headrest support.
3. Lower the headrest to the desired position (3).

**\* NOTICE**

If you recline the seatback towards the front with the headrest and seat cushion raised, the headrest may come in contact with the sun visor or other parts of the vehicle.



**Removing headrest**

Type A



Type B



ODL3A030012

To remove the headrest:

1. Recline the seatback (2) with the recline lever or switch (1).
2. Raise headrest as far as it can go.
3. Press the headrest release button (3) while pulling the headrest up (4).

**⚠ WARNING**

**Removing headrest**

NEVER allow anyone to ride in a seat with the headrest removed or reversed. Headrests can provide critical neck and head support in a crash.

**Reinstalling headrest**

Type A



ODL3A030013

Type B



ODL3A030014

To reinstall the headrest:

1. Put the headrest poles (2) into the holes while pressing the release button (1).
2. Recline the seatback (4) with the recline lever or switch (3).
3. Adjust the headrest to the appropriate height.

**⚠ WARNING**

**Headrest reinstallation**

To reduce the risk of injury to the head or neck, always make sure the headrest is locked into position and adjusted properly after reinstalling.

### Seatback pocket (if equipped)

The seatback pocket is provided on the back of the front passenger's seatbacks.



#### **⚠ WARNING**

#### Seatback pockets

Do not put heavy or sharp objects in the seatback pockets. In an accident they could come loose from the pocket and injure vehicle occupants.

### Rear seat adjustment

#### Headrest for rear seat

The rear seat is equipped with headrests in all the seating positions for the occupant's safety and comfort.



The headrest not only provides comfort for passengers, but also helps protect

the head and neck in the event of a collision.

To maximize the effectiveness in case of accidents, the headrest should be adjusted so the middle of the headrest is as high as the center of gravity of an occupant's head. Generally, the center of gravity of most people's heads is similar with the height as the top of their eyes.

Also, adjust the headrest as close to your head as possible. For this reason, the use of a cushion that holds the body away from the seatback is not recommended.

#### Adjusting the height up and down (if equipped)



- To raise the headrest, pull it up to the desired position (1).
- To lower the headrest, push and hold the release button (2) on the headrest support and lower the headrest to the desired position (3).

## Removal and reinstallation (if equipped)



- To remove the headrest, raise it as far as it can go then press the release button (1) While pulling the headrest upward (2).
- To reinstall the headrest, put the headrest poles (3) into the holes while pressing the release button (1).

Then adjust it to the appropriate height and ensure that it locks in position.

## Armrest (if equipped)



To use the armrest, pull it forward from the seatback.

## Folding the rear seat (if equipped)

The rear seatbacks can be folded to facilitate carrying long items or to increase the luggage capacity of the vehicle.

### \* NOTICE

#### Folded Seatback

Do not sit on folded down seatbacks. The purpose of the fold-down rear seatbacks is to allow you to carry longer objects that could not otherwise be accommodated.

- Never allow a passenger to sit on top of the folded down seatback while the car is moving. This is not a proper seating position since the seat has important crash protection features and seat belts are not available in this seat configuration.
- To reduce the risk of injury caused by sliding cargo within the passenger compartment of the vehicle, objects carried on the folded down seatback should not extend higher than the top of the front seats.

To fold down the rear seatback:

1. Set the front seatback to the upright position and if necessary, slide the front seat forward.
2. Lower the rear headrests to the lowest position.



**⚠ WARNING**

**Objects**

Objects carried on the folded down seatback should not extend higher than the top of the front seatbacks. This could allow cargo to slide forward and cause injury or damage during sudden stops.

3. Pull on the seatback folding lever located in the trunk.



4. If you pull both seatback folding levers, all rear seatbacks will be folded.



5. To use the rear seat, lift and pull the seatback rearward. Pull the seatback firmly until it clicks into place. Make sure the seatback is locked in place.

**⚠ WARNING**

Do not fold the rear passenger seats down until the driver has positioned his seat properly. Doing so can cause the driver to operate the vehicle out of position and increase the risk of bodily injury in a sudden stop or collision.

**⚠ WARNING**

**Uprighting seat**

When you return the seatback to its upright position, hold the seatback and return it slowly. If the seatback is returned without holding it, the back of the seat could spring forward, resulting in injury caused by being struck by the seatback.

**⚠ WARNING**

**Rear Seatback**

To ensure maximum protection in the event of an accident or sudden stop, when returning the rear seat to the upright position:

- Be careful not to damage the seat belt webbing or buckle.
- Do not allow the seat belt webbing or buckle to become pinched or caught in the rear seat.
- Ensure the seatback is completely locked into its upright position by pushing on the top of the seatback.

### CAUTION

#### **Damaging rear seat belt buckles**

When you fold the rear seatback, insert the buckle between the rear seatback and cushion. Doing so can prevent the buckle from being damaged by the rear seatback.

### CAUTION

#### **Rear seat belts**

When returning the rear seatbacks to the upright position, remember to return the rear shoulder belts to their proper position.

### CAUTION

Be careful when loading cargo through the rear passenger seats to prevent damage to the vehicle interior.

### WARNING

#### **Cargo**

Cargo should always be secured to prevent it from being thrown about the vehicle in a collision and causing injury to the vehicle occupants. Do not place objects in the rear seats, since they cannot be properly secured and may hit the front seat occupants in a collision.

### WARNING

#### **Cargo loading**

Make sure the engine is off, the automatic transmission/dual clutch transmission is in P (Park) and the parking brake is securely applied whenever loading or unloading cargo. Failure to take these steps may allow the vehicle to move if the shift lever is inadvertently moved to another position.

## Seat belts

Seat belts are designed to bear upon the bony structure of the body, and should be worn low across the front of the pelvis, chest and shoulders.

### Seat belt restraint system

For maximum restraint system protection, the seat belts must always be used whenever the vehicle is moving.

- A properly positioned shoulder belt should be positioned midway over your shoulder, across your collarbone.
- Never allow children to ride in the front passenger seat. See "Child Restraint System (CRS)" on page 3-26 for further discussion.

#### WARNING

#### Twisted seat belt

Make sure your seat belt is not twisted when worn. A twisted seat belt may not properly protect you in an accident and could even cut into your body.

#### WARNING

#### Shoulder Belt

- Never wear the shoulder belt under your arm or behind your back. An improperly positioned shoulder belt cannot protect the occupant in the event of a crash.
- Always wear both the shoulder portion and lap portion of the lap/shoulder belt.

#### WARNING

#### Damaged seat belt

Any damage in webbing or hardware may lead to serious injury or death in a crash. For your safety, the entire seat belt assembly should be replaced by a

Kia authorized dealer if any part of the seatbelt webbing or hardware is damaged.

Seat belts are designed to bear upon the bony structure of the body, and should be worn low across the front of the pelvis, chest and shoulders, as applicable; wearing the lap section of the belt across the abdominal area must be avoided.

Seat belts should be adjusted as firmly as possible, consistent with comfort, to provide the protection for which they have been designed.

A slack belt will greatly reduce the protection afforded to the wearer.

Care should be taken to avoid contamination of the webbing with polishes, oils and chemicals, and particularly battery acid. Cleaning may safely be carried out using mild soap and water. The belt should be replaced if webbing becomes frayed, contaminated or damaged.

- No modifications or additions should be made by the user which would either prevent the seat belt adjusting devices from operating to remove slack, or prevent the seat belt assembly from being adjusted to remove slack.
- When you fasten the seat belt, be careful not to latch the seat belt in buckles of other seats. It is very dangerous and you may not be protected by the seat belt properly.
- Do not unfasten the seat belt and do not fasten and unfasten the seat belt repeatedly while driving. This could result in loss of control, and an accident causing death, serious injury, or property damage.
- When fastening the seat belt, make sure that the seat belt does not pass



over objects that are hard or can break easily.

**⚠ WARNING**

**Seat belt buckle**

Do not allow foreign material (gum, crumbs, coins, liquids, etc.) to obstruct the seat belt buckle. This may prevent the seat belt from fastening securely.

**Seat belt warning**



The seat belt warning light and warning chime operate under the following conditions.

**Driver and Front Passenger's seat belt warning**

As a reminder, the driver and front passenger's seat belt warning lights will appear for approximately 6 seconds each time you turn the ENGINE START/ STOP button ON regardless of belt fastening. If the seatbelt is not fastened, the warning chime will sound for about 6 seconds.

If you start to drive without the seat belt fastened over 5 mph (9 km/h) and less than 12 mph (20 km/h), the corresponding warning light will appear. The warning light will turn off when the vehicle speed drops below 5 mph (9 km/h).

If you start to drive without the seat belt fastened or you unfasten the seat belt when you drive 12 mph (20 km/h) and faster, the warning light will blink and warning chime will sound for approximately 100 seconds. When the seat belt is unfastened during driving, the warning light will appear when the speed is under 12 mph (20 km/h). When the speed is 12 mph (20 km/h) and faster, the warning light will blink and warning chime will sound for approximately 100 seconds.

**\* NOTICE**

- Even if the front passenger seat is not occupied, the seat belt warning light will appear for 6 seconds.
- The front passenger's seat belt warning may operate when luggage is placed on the front passenger seat.

**Seat belt - Driver's 3-point system with emergency locking retractor**

The following explains how to fasten and adjust the driver's seat belt.

**Fastening the your seat belt:**



- Pull it out of the retractor and insert the metal tab (1) into the buckle (2).

There will be an audible "click" when the tab locks into the buckle.

**⚠ WARNING**

You should place the lap belt portion as low as possible and snugly across your hips. If the lap belt is located too high on your waist, it may increase the chance of injury in the event of a collision.



The arm closest to the seat belt buckle should be over the belt while the other arm should be under the belt as shown in the illustration. Never wear the seat belt under the arm closest to the door.

The seat belt automatically adjusts to the proper length only after the lap belt portion is adjusted manually so that it fits snugly around your hips. If you lean forward in a slow, easy motion, the belt will extend and let you move around. If there is a sudden stop or impact, however, the belt will lock into position. It will also lock if you try to lean forward too quickly.

**\* NOTICE**

If you are not able to pull out the seat belt from the retractor, firmly pull the belt out and release it. Then you will be able to pull the belt out smoothly.

**Releasing the seat belt:**



- Press the release button (1) in the locking buckle.

When it is released, the belt should automatically draw back into the retractor.

If this does not happen, check the belt to be sure it is not twisted, then try again.

**Adjusting the height of shoulder belt**

You can adjust the height of the shoulder belt anchor to one of the 4 positions for maximum comfort and safety.

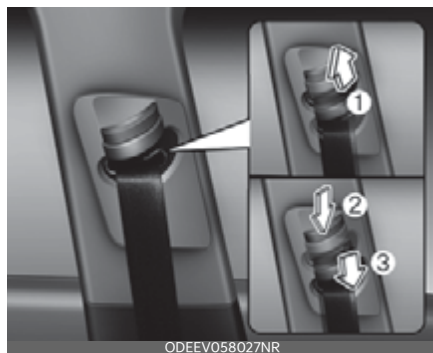

The height of the adjusting seat belt should not be too close to your neck. The shoulder portion should be adjusted so that it lies across your chest and mid-way over your shoulder near the door and not your neck.

To adjust the height of the seat belt anchor, lower or raise the height adjuster into an appropriate position.

- To raise the height adjuster, pull it up (1).
- To lower it, push it down (3) while pressing the height adjuster button (2).

Release the button to lock the anchor into position. Try sliding the height adjuster to make sure that it has locked into position.

Improperly positioned seat belts can cause serious injuries in an accident.

### **WARNING**

#### **Shoulder belt positioning**

Verify the shoulder belt anchor is locked into position at the appropriate height. Never position the shoulder belt across your neck or face. Improperly positioned seat belts can cause serious injuries in an accident.

### **WARNING**

#### **Seat belt replacement**

After a collision, the seat belt system should be inspected to ensure it is operating normally. Replace any belts that are not functioning appropriately.

### **Seat belts - Front passenger and rear seat 3-point system with combination locking retractor**

The following explains how to fasten the passenger's and rear seat belts.

#### **Fastening your seat belt:**

Combination retractor type seat belts are installed in the rear seat positions to help accommodate the installation of Child Restraint System. Although a com-

bination retractor is also installed in the front passenger seat position, it is strongly recommended that children always be seated in the rear seat. NEVER place any infant restraint system in the front seat of the vehicle.

This type of seat belt combines the features of both an emergency locking retractor seat belt and an automatic locking retractor seat belt.

- Pull it out of the retractor and insert the metal tab into the buckle. There will be an audible "click" when the tab locks into the buckle. When not securing a child restraint, the seat belt operates in the same way as the driver's seat belt (emergency locking retractor type).

It automatically adjusts to the proper length only after the lap belt portion of the seat belt is adjusted manually so that it fits snugly around your hips.

When the seat belt is fully extended from the retractor to allow the installation of a Child Restraint System, the seat belt operation changes to allow the belt to retract, but not to extend (automatic locking retractor type). Refer to "Securing a child restraint with a lap/shoulder belt" on page 3-32.

### **NOTICE**

Although the combination retractor provides the same level of protection for seated passengers in either emergency or automatic locking modes, have the seated passengers use the emergency locking feature for improved convenience. The automatic locking function is intended to facilitate child restraint installation. To convert from the automatic locking feature to the emergency

locking operation mode, allow the unbuckled seat belt to fully retract.

**⚠ CAUTION**

Do NOT fold down the left portion of the rear seatback when the rear center seat belt is buckled. ALWAYS UNBUCKLE the rear center seat belt before folding down the left portion of the rear seatback. If the rear center seat belt is buckled when the left portion of the rear seatback is folded down, distortion and damage to the top portion of the seatback and seat belt garnish may result, causing the seatback to lock into the folded down position.

The seat belt should be locked into the buckle on each seat cushion to be properly fastened.



1. Rear right seat belt fastening buckle
2. Rear center seat belt fastening buckle
3. Rear left seat belt fastening buckle

**⚠ WARNING**

Prior to fastening the rear seat belts, ensure the latch matches the seat belt buckle. Forcefully fastening the left or right seat belt to the center buckle can

result in an improper fastening scenario that will not protect you in an accident.

When using the rear center seat belt, the buckle with the "CENTER" mark must be used.



**Stowing the rear seat belt**

The rear seat belt buckles can be stowed in the pocket between the rear seatback and cushion when not in use.



1. Route the seat belt webbing through the rear seat belt guides. It will help keep the belts from being trapped behind or under the seats.
2. After inserting the seat belt, tighten the belt webbing by pulling it up.

**⚠ CAUTION**

When pulling out to wear the seat belt, the tongue should be slowly pulled out of the seat belt guide so that the seat belt guide does not come off the trim.

**Pre-tensioner seat belt**

Your vehicle is equipped with pre-tensioner seat belts at the front outboard seating positions.

The purpose of the pre-tensioner is to make sure that the seat belts fit tightly against the occupant's body in certain collisions.

The pre-tensioner seat belts may be activated in a collision when the collision is severe enough.

When the vehicle stops suddenly, or if the occupant tries to lean forward too quickly, the seat belt retractor will lock into position. In certain frontal collisions, the pre-tensioner will activate and pull the seat belt into tighter contact against the occupant's body.

If the system senses excessive tension on the driver or passenger's seat belt when the pre-tensioner activates, the load limiter inside the pre-tensioner will release some of the pressure on the affected seat belt. (if equipped)

**⚠ WARNING**

For your safety, be sure that the belt webbing is not loose or twisted and always sit properly on your seat.

**\* NOTICE**

The pre-tensioner may activate not only in a frontal collision but also in a side collision, if the vehicle is equipped with a side or curtain air bag.

The seat belt pre-tensioner system consists mainly of the following components. Their locations are shown in the illustration:

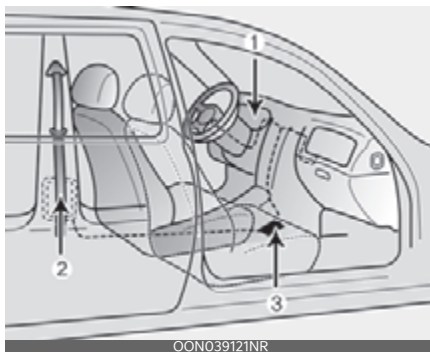

1. Supplemental Restraint System (SRS) air bag warning light
2. Retractor pre-tensioner assembly
3. SRS Control Module

**⚠ WARNING****Skin Irritation**

Wash all exposed skin areas thoroughly after an accident in which the pre-tensioner seat belts were activated. The fine dust from the pre-tensioner activation may cause skin irritation and should not be inhaled for prolonged periods.

**\* NOTICE**

- Both the driver's and front passenger's seat belt pre-tensioner systems may be activated not only in certain frontal collisions, but also in certain side collisions or rollovers, if the vehicle is equipped with a side or curtain air bag.
- Because the sensor that activates the SRS air bag is connected with the pre-tensioner seat belt, the SRS air bag warning light  on the instrument panel will appear for approximately 3~6 seconds after the ignition switch has been turned to the ON position, and then it should turn off.
- If the pre-tensioner seat belt system is not working properly, this warning light will appear even if there is not a malfunction with the SRS air bag. If the SRS air bag warning light does not appear when the ENGINE START/ STOP button has been turned to the ON position, or if it remains appeared for approximately 6 seconds, or if it appears while the vehicle is being driven, have an authorized Kia dealer inspect the pre-tensioner seat belt and SRS air bag system as soon as possible.

**\* NOTICE**

Do not attempt to service or repair the pre-tensioner seat belt system in any manner. Do not attempt to inspect or replace the pre-tensioner seat belts yourself. This must be done by an authorized Kia dealer.

**⚠ WARNING****Hot pre-tensioner**

Do not touch the pre-tensioner seat belt assemblies for several minutes after they have been activated. When the pre-tensioner seat belt mechanism fires during a collision the pre-tensioner becomes hot and can burn you.

Pre-tensioners are designed to operate only one time. After activation, pre-tensioner seat belts must be replaced. If the pre-tensioner must be replaced, contact an authorized Kia dealer.

**Seat belt precautions**

Take the following precautions when using seat belts.

**Infant or small child**

All 50 states have child restraint laws. You should be aware of the specific requirements in your state. Child and/or infant seats must be properly placed and installed in the rear seat. For more information about the use of these restraints, refer to "Child Restraint System (CRS)" on page 3-26.

**\* NOTICE**

Small children are best protected from injury in an accident when properly restrained in the rear seat by a Child Restraint System that meets the requirements of the Federal Motor Vehicle Safety Standards (FMVSS). Before buying any Child Restraint System, make sure that it has a label certifying that it meets Federal Motor Vehicle Safety Standard 213. The restraint must be appropriate for your child's height and weight. Check the label on the child restraint for this information. Refer to

"Child Restraint System (CRS)" on page 3-26.

---

### Larger children

Children who are too large for Child Restraint System should always occupy the rear seat and use the available lap/shoulder belts. The lap portion should be fastened and snug on the hips as low as possible. Check periodically to insure that the belt fits. A child's squirming could put the belt out of position. Children are given the most safety in the event of an accident when they are restrained by a proper restraint system in the rear seat. If a larger child (over age 13) must be seated in the front seat, the child should be securely restrained by the available lap/shoulder belt and the seat should be placed in the rearmost position. Children age 13 and under should be restrained securely in the rear seat. NEVER place a child age 13 and under in the front seat. NEVER place a rear facing child seat in the front seat of a vehicle.

If the shoulder belt portion slightly touches the child's neck or face, try placing the child closer to the center of the vehicle. If the shoulder belt still touches their face or neck they need to be returned to a Child Restraint System.

### WARNING

#### Small children

Do not allow small children to ride in the vehicle without an appropriate Child Restraint System. If the shoulder belt comes in contact with your child's neck or face, your child is too small to ride in the vehicle without support of a Child Restraint System. In a crash, the seat

belt will inflict injury to your child's neck, throat and face.

---

### Restraint of pregnant women

Pregnant women should wear lap/shoulder belt assemblies whenever possible according to specific recommendations by their doctors. The lap portion of the belt should be worn AS SECURELY AND LOW AS POSSIBLE.

### WARNING

#### Pregnant women

Pregnant women must never place the lap portion of the seat belt above or on the abdomen where the fetus is located. The force of the seat belt during a collision will crush the fetus.

---

### Injured person

A seat belt should be used when an injured person is being transported. When this is necessary, you should consult a physician for recommendations.

### One person per belt

Two people (including children) should never attempt to use a single seat belt. This could increase the severity of injuries in case of an accident.

### Do not lie down

To reduce the chance of injuries in the event of an accident and to achieve maximum effectiveness of the restraint system, all passengers should be sitting up and the front and rear seats should be in an upright position when the vehicle is moving. A seat belt cannot provide proper protection if the person is lying

down in the rear seat or if the front and rear seats are in a reclined position.

### Care of seat belts

Seat belt systems should never be disassembled or modified. In addition, care should be taken to assure that seat belts and belt hardware are not damaged by seat hinges, doors or other abuse.

#### **WARNING**

#### **Pinched seat belt**

Make sure that the webbing and/or buckle does not get caught or pinched in the rear seat when returning the rear seatback to its upright position. A caught or pinched webbing/buckle may become damaged and could fail during a collision or sudden stop.

#### **WARNING**

Seatbelts can become hot in a vehicle that has been closed up in sunny weather. Please handle with care, as they could burn infants and children, if used abruptly.

### Periodic inspection

All seat belts should be inspected periodically for wear or damage of any kind. For your safety, any damaged parts should be replaced as soon as possible by a Kia authorized dealer.

### Keep belts clean and dry

Seat belts should be kept clean and dry. If belts become dirty, they can be cleaned by using a mild soap solution and warm water. Bleach, dye, strong detergents or abrasives should not be used because they may damage and weaken the fabric.

### When to replace seat belts

The entire in-use seat belt assembly or assemblies should be replaced if the vehicle has been involved in an accident. This should be done even if no damage is visible. Additional questions concerning seat belt operation should be directed to an authorized Kia dealer.



## Child Restraint System (CRS)

Infants and younger children must be restrained in an appropriate rear-facing or forward-facing Child Restraint System (CRS) that has first been properly secured to the rear seat of the vehicle.

Please refer to your state or federal laws for child seating requirements in the operation of a motor vehicle.

### Children always in the rear

Children under age 13 must always ride in the rear seats and must always be properly restrained to minimize the risk of injury in an accident, sudden stop or sudden maneuver.

#### WARNING

#### Restraint Location

Never install a child or infant seat on the front passenger's seat. A child riding in the front passenger seat can be forcefully struck by an inflating airbag and be seriously injured.

#### WARNING

#### Hot Child Restraint

A Child Restraint System can become very hot if it is left in a closed vehicle on a sunny day. Be sure to check the seat cover, buckles and latches before placing a child in the restraint system.

According to accident statistics, children are safer when properly restrained in the rear seats than in the front seat. Even with air bags, children can be seriously injured or killed. Children too large for a child restraint must use the seat belts provided.

All 50 states have child restraint laws which require children to travel in approved child restraint devices. The

laws governing the age or height/weight restrictions at which seat belts can be used instead of child restraints differs among states, so you should be aware of the specific requirements in your state, and where you are traveling.

The CRS must be properly placed and installed in the rear seat. You must use a commercially available CRS that meets the requirements of the Federal Motor Vehicle Safety Standards (FMVSS).

A CRS is generally designed to be secured in a vehicle seat by lap belt portion of a lap/shoulder belt, or by a LATCH system in the rear seats of the vehicle.

## Child Restraint System (CRS)

Infants and younger children must be restrained in an appropriate rear-facing or forward-facing CRS that has first been properly secured to the rear seat of the vehicle. Read and comply with the instructions for installation and use provided by the manufacturer of the CRS.

## Child Restraint Installation

An improperly secured child restraint can increase the risk of serious injury or death in an accident. Always take the following precautions when using a Child Restraint System:

- Always follow the Child Restraint System manufacturer's instructions for installation and use.
- Always properly restrain your child in the child restraint.
- If the vehicle head restraint prevents proper installation of a child seat (as described in the Child Restraint System manual), the head restraint of the

respective seating position shall be readjusted or entirely removed.

- Do not use an infant carrier or a child safety seat that "hooks" over a seat-back as it may not provide adequate protection in an accident.
- A child restraint in the center seating position may also contact or push up against the safety belt buckles, which can damage the buckles and make them unusable or unsafe. Always check that the child restraint does not contact any of the safety belt buckles. Check the placement of the child restraint regularly to make sure that it has not shifted and come into contact with any of the safety belt buckles.

#### \* NOTICE

After an accident, have a Kia dealer check the Child Restraint System, seat belts, tether anchors and lower anchors.

### Selecting a Child Restraint System (CRS)

When selecting a CRS for your child, always:

- Make sure the CRS has a label certifying that it meets applicable Federal Motor Vehicle Safety Standards (FMVSS 213).
- Select a child restraint based on your child's height and weight. The required label or the instructions for use typically provide this information.
- Select a child restraint that fits the vehicle seating position where it will be used.
- Read and comply with the warnings and instructions for installation and use provided with the CRS.
- The American Academy of Pediatrics provides helpful fit and safety infor-

mation about child restraints at [www.healthychildren.org](http://www.healthychildren.org).

#### ⚠ WARNING

##### Holding children

Never hold a child in your arms or lap when riding in a vehicle. The violent forces created during a crash will tear the child from your arms and throw the child against the car's interior. Always use a Child Restraint System which is appropriate for your child's height and weight.

#### ⚠ WARNING

##### Unattended children, the elderly or pets

An enclosed vehicle can become extremely hot, causing death or severe injury such as heatstroke to unattended children, the elderly or pets who cannot escape the vehicle. When left or trapped in a hot vehicle, make sure to stay hydrated and avoid sun exposure through the vehicle's windshield.

Furthermore, children might operate features of the vehicle that could injure them, or they could encounter other harm, possibly from someone gaining entry to the vehicle. Never leave children or animals unattended in your vehicle.

#### ⚠ WARNING

##### Seat belt use

Do not use one seat belt for two occupants at the same time. This will eliminate any safety benefit provided by the seat belt to the occupants.

## CRS types

There are three main types of the CRS: rear-facing seats, forward-facing seats, and booster seats. They are classified according to the child's age, height and weight.

### Backward-facing child seats



A rear-facing child seat provides restraint with the seating surface against the back of the child. The harness system holds the child in place, and in an accident, acts to keep the child positioned in the seat and reduces the stress to the neck and spinal cord.

All children under age one must always ride in a rear-facing infant child restraint.

Convertible and 3-in-1 child seats typically have higher height and weight limits for the rear-facing position, allowing you to keep your child rear-facing for a longer period of time.

Continue to use a rear-facing child seat for as long as your child will fit within the height and weight limits allowed by the child seat manufacturer. It's the best way to keep them safe. Once your child has outgrown the rear-facing child restraint, your child is ready for a forward-facing child restraint with a harness.

### Forward-facing child restraints



A forward-facing child seat provides restraint for the child's body with a harness. Keep children in a forward-facing child seat with a harness until they reach the top height or weight limit allowed by your child restraint's manufacturer.

Once your child outgrows the forward-facing child restraint, your child is ready for a booster seat.

### Booster seats

A booster seat is a restraint designed to improve the fit of the vehicle's seat belt system. A booster seat positions the seat belt so that it fits properly over the lap of your child.

Keep your child in a booster seat until they are big enough to sit in the seat without a booster and still have the seat belt fit properly. For a seat belt to fit properly, the lap belt must lie snugly across the upper thighs, not the stomach. The shoulder belt should lie snug across the shoulder and chest and not across the neck or face. Children under age 13 must always ride in the rear seats and must always be properly restrained to minimize the risk of injury.

## Installing a Child Restraint System (CRS)

After selecting a proper child seat for your child, check to make sure it fits properly in your vehicle.

Follow the instructions provided by the manufacturer when installing the child seat. Note these general steps when installing the seat to your vehicle:

- **Properly secure the child restraint to the vehicle.** All child restraints must be secured to the vehicle with the lap part of a lap/shoulder belt or with the LATCH system.
- **Make sure the child restraint is firmly secured.** After installing a child restraint to the vehicle, push and pull the seat forward and from side-to-side to verify that it is securely attached to the seat. A child restraint secured with a seat belt should be installed as firmly as possible. However, some side-to-side movement can be expected.
- **Secure the child in the child restraint.** Make sure the child is properly strapped in the child restraint according to the manufacturer instructions.

## Lower Anchors and Tether for Children (LATCH) system

The LATCH system holds a child restraint during driving and in an accident. This system is designed to make installation of the child restraint easier and reduce the possibility of improperly installing your child restraint. The LATCH system uses anchors in the vehicle and attachments on the child restraint. The LATCH system eliminates the need to use seat belts to secure the child restraint to the rear seats.

Lower anchors are metal bars built into the vehicle. There are two lower anchors for each LATCH seating position that will accommodate a child restraint with lower attachments.

To use the LATCH system in your vehicle, you must have a child restraint with LATCH attachments.

The child seat manufacturer will provide you with instructions on how to use the child seat with its attachments for the LATCH lower anchors.



LATCH anchors have been provided in the left and right outboard rear seating positions. Their locations are shown in the illustration. There are no LATCH anchors provided for the center rear seating position.

### **⚠ WARNING**

#### **LATCH Lower Anchors**

Never attempt to attach a LATCH equipped seat in the center seating position. LATCH lower anchors are only to be used in the left and right rear outboard seating positions. You may damage the anchors or the anchors may fail and break in a collision if the seat is in the center seating position.

The lower anchor position indicator symbols are located on the left and right rear

seatbacks to identify the position of the lower anchors in your vehicle (see arrows in illustration).

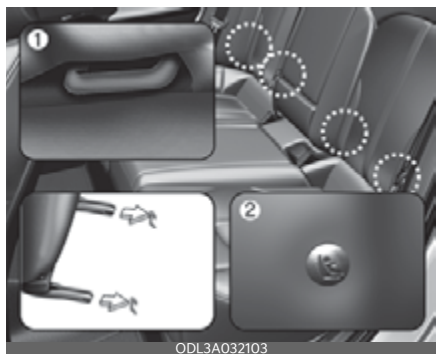

1. Lower Anchor
2. Lower Anchor position indicator

The LATCH anchors are located between the seatback and the seat cushion of the rear seat left and right outboard seating positions.

To use the lower anchor, push the upper portion of the lower anchor cover.

### Securing a child restraint with the LATCH anchors system

To install a LATCH-compatible child restraint in either of the rear outboard seating positions:

1. Move the seat belt buckle away from the lower anchors. Otherwise, the webbing or buckle can be damaged by the latch anchor, which can make them become unusable or unsafe.
2. Move any other objects away from the anchors that could prevent a secure connection between the child restraint and the lower anchors.
3. Place the child restraint on the vehicle seat, then attach the seat to the lower anchors according to the instructions provided by the child restraint manufacturer.

4. Follow the child restraint instructions for properly adjusting and tightening the lower attachments on the child restraint to the lower anchors.

### **⚠ WARNING**

Take the following precautions when using the LATCH system:

- Read and follow all installation instructions provided with your Child Restraint System.
- To prevent the child from reaching and taking hold of the unused seat belts, buckle all unused rear seat belts before the child is placed into the vehicle. Lock each unused seatbelt following the instructions in the "automatic locking mode" subsection, and place the webbing behind the child seat or against an unused seatback. Children can be strangled if a shoulder belt becomes wrapped around their neck and the seat belt tightens.
- NEVER attach more than one child restraint to a single anchor. This could cause the anchor or attachment to come loose or break.
- Always have the LATCH system inspected by your authorized Kia dealer after an accident. An accident can damage the LATCH system and may not properly secure the child restraint.

### **\* NOTICE**

The recommended maximum weight for the LATCH system is 65 lbs. (30 kg). When selecting a proper child restraint, consider that the maximum total weight of the child plus the child restraint should be less than 65 lbs. (30 kg).

As a guide, the MAX child restraint weight should be determined by the following calculation:

Child Restraint Weight = 65 - (child's total weight in lbs.)

### Securing a child restraint seat with "Tether Anchor" system (if equipped)



First secure the child restraint with the LATCH lower anchors or the seat belt. If the child restraint manufacturer recommends that the top tether strap be attached, attach and tighten the top tether strap to the top tether strap anchor.

Child Restraint hook holders are located on the package tray.

#### **⚠ WARNING**

Take the following precautions when installing the tether strap:

- Read and follow all installation instructions provided with your Child Restraint System.
- NEVER attach more than one child restraint to a single tether anchor. This could cause the anchor or attachment to come loose or break.

- Do not attach the tether strap to anything other than the correct tether anchor. It may not work properly if attached to something else.
- Do not use the tether anchors for adult seat belts or harnesses, or for attaching other items or equipment to the vehicle.
- Always fasten the seat belts behind the child restraint seat when they are not used to secure the child seat. Failure to do so may result in child strangulation.

To install the tether anchor:



1. Route the Child Restraint System seat strap over the seatback.  
For vehicles with adjustable headrest, route the tether strap under the headrest and between the headrest posts, otherwise route the tether strap over the top of the seatback.
2. Connect the top-tether to the top-tether anchorage, then tighten the top-tether according to the instructions of your Child Restraint System's manufacturer to firmly attach the Child Restraint System to the seat.
3. Check that the child restraint is securely attached to the seat by push-

ing and pulling the seat forward and from side-to-side.

### Securing a child restraint with a lap/shoulder belt

When not using the LATCH system, all child restraints must be secured to a vehicle rear seat with the lap part of a lap/shoulder belt.

### Automatic locking mode



All passenger seat belts move freely under normal conditions and only lock under extreme or emergency conditions (emergency locking mode). So, in order to secure a child restraint, you must manually pull the seat belt all the way out to shift the retractor to the "automatic locking" mode.

The "automatic locking" mode will help prevent the normal movement of the child in the vehicle from causing the seat belt to loosen and compromise the CRS. To install a CRS on the rear seats, do the following:

1. Place the CRS on a rear seat and route the lap/shoulder belt around or through the child restraint, following the restraint manufacturer's instructions.

Be sure the seat belt webbing is not twisted.

2. Fasten the lap/shoulder belt latch into the buckle. Listen for the distinct "click" sound.

Position the release button so that it is easy to access in case of an emergency.



3. Pull the shoulder portion of the seat belt all the way out. When the shoulder portion of the seat belt is fully extended, it will shift the retractor to the "automatic locking" (child restraint) mode.



4. Slowly allow the shoulder portion of the seat belt to retract and listen for an audible "clicking" or "ratcheting" sound. This indicates that the retractor is in the "automatic locking" mode.

If no distinct sound is heard, repeat steps 3 and 4.



5. Remove as much slack from the belt as possible by pushing down on the CRS while feeding the shoulder belt back into the retractor.
6. Push and pull on the CRS to confirm that the seat belt is holding it firmly in place. If it is not, release the seat belt and repeat steps 2 through 6.
7. Double check that the retractor is in the "automatic locking" mode by attempting to pull more of the seat belt out of the retractor. If you cannot, the retractor is in the "automatic locking" mode.

If your CRS manufacturer instructs or recommends you to use a tether anchor with the lap/shoulder belt, refer to "Securing a child restraint seat with "Tether Anchor" system (if equipped)" on page 3-31 for more information.

### \* NOTICE

When the seat belt is allowed to retract to its fully stowed position, the retractor will automatically switch from the "automatic locking" mode to the emergency lock mode for normal adult usage.

### ⚠ WARNING

#### Auto lock mode

Set the retractor to Automatic Lock mode when installing any Child Restraint System. If the retractor is not in the automatic locking mode, the child restraint can move when your vehicle turns or stops suddenly. A child can be seriously injured or killed if the child restraint is not properly anchored in the car.

To remove the child restraint, press the release button on the buckle and then pull the lap/shoulder belt out of the restraint and allow the seat belt to retract fully.



## Air bag - Advanced Supplemental Restraint System

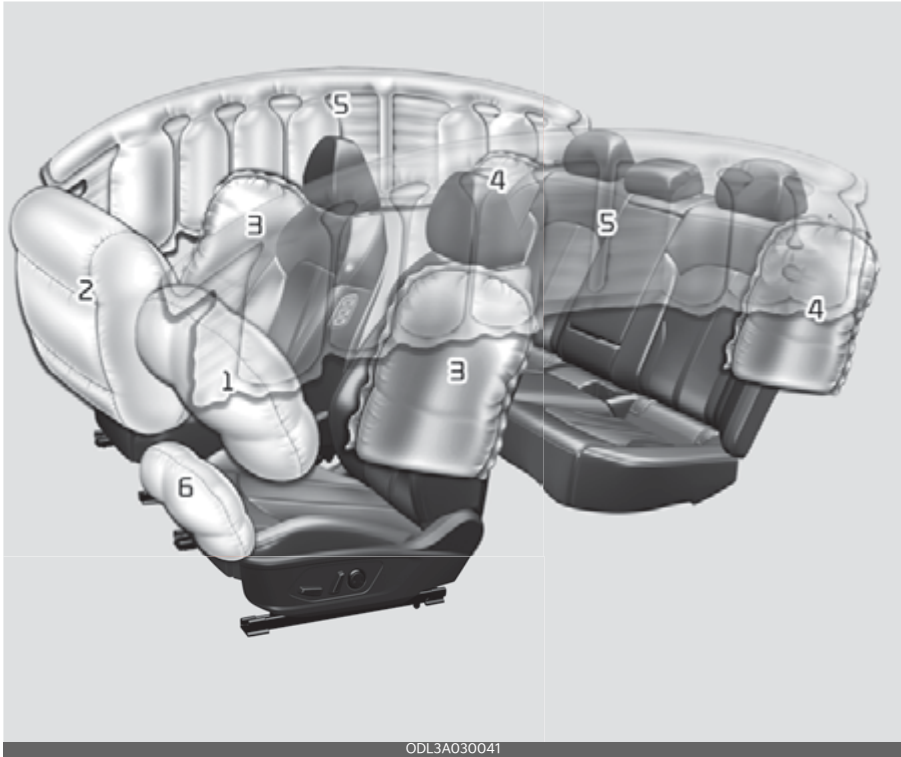

ODL3A030041

\* The actual air bags in the vehicle may differ from the illustration.

1. Driver's front air bag
2. Passenger's front air bag
3. Side air bag (front)
4. Side air bag (rear)
5. Curtain air bag
6. Driver's knee air bag

Even in vehicles with air bags, you and your passengers must always wear the safety belts provided in order to minimize the risk and severity of injury in the event of a collision or rollover.

## How does the air bag system operate?

- Air bags are activated (able to inflate if necessary) only when the ENGINE START/STOP button is in the ON position or approximately within 3 minutes after ignition off.
- The appropriate air bags inflate instantly in the event of a serious frontal collision or side collision in order to help protect the occupants from serious physical injury.
- There is no single speed at which the air bags will inflate. Generally, air bags are designed to inflate based upon the severity of a collision and its direction, etc. Several factors determine whether the sensors produce an electronic deployment / inflation signal.
- Air bags will not deploy in every crash or collision situations. Air bag deployment depends on a number of factors including vehicle speed, angles of impact, and, the density and stiffness of the vehicles or objects which your vehicle hits in the collision. The determining factors are not limited to those mentioned above.
- The front air bags will completely inflate and deflate in an instant. It is virtually impossible for you to see the air bags inflate during an accident. It is much more likely that you will simply see the deflated air bags hanging out of their storage compartments after the collision.
- In addition to inflating in serious side collisions, side and/or curtain air bags will inflate if the sensing system detects a rollover.
- When a rollover is detected, side and/or curtain airbags will remain inflated longer. This helps provide protection

from ejection, especially when used in conjunction with the seat belts.

- In order to help provide protection, the air bags must inflate rapidly. The airbag inflates extremely fast between the occupant and the vehicle structures before the occupant impacts the vehicle structures. This speed of inflation reduces the risk of serious or life-threatening injuries and is thus a necessary part of the air bag design. However, airbag inflation can also cause injuries which can include facial abrasions, bruises and broken bones. This is because the rapid inflation also causes the airbags to expand with a great deal of force.
- **There are even circumstances under which contact with the steering wheel or passenger air bag can cause fatal injuries, especially if the occupant is positioned excessively close to the steering wheel or passenger air bag.**

### **WARNING**

#### **Airbag inflation**

Sit as far back as possible from the steering wheel while still maintaining comfortable control of the vehicle. A distance of at least 10 inches (25 cm) from your chest to the steering wheel is recommended. Failure to do so can result in airbag inflation injuries to the driver.

#### **Noise and smoke**

When inflated, the air bags make a loud noise and leave smoke and powder in the air inside the vehicle. This is normal and is a result of the ignition of the air bag inflator. After the air bag inflates, you may feel substantial discomfort in breathing due to the contact of your

chest with both the seat belt and the air bag, as well as from breathing the smoke and powder. **Open your doors and/or windows as soon as possible after impact in order to reduce discomfort and prevent prolonged exposure to the smoke and powder.**

Though smoke and powder are non-toxic, it may cause irritation to the skin (eyes, nose and throat, etc). If this is the case, wash and rinse with cold water immediately and consult a doctor if the symptom persists.

**⚠ WARNING**

**Hot components**

Do not touch the air bag storage area's internal components immediately after airbag inflation. The air bag related parts in the steering wheel, instrument panel and the roof rails above the front and rear doors are very hot. Hot components can result in burn injuries.

**⚠ WARNING**

Do not install or place any accessories near air bag deployment areas, such as the instrument panel, windows, pillars, and roof rails.

**Do not install a child restraint on the front passenger's seat**



ODEEV058046NR

Never place a rear-facing child restraint in the front passenger's seat.

If the air bag deploys, it would impact the rear-facing child restraint, causing serious or fatal injury.

In addition, do not place front-facing child restraints in the front passenger's seat. If the front passenger air bag inflates, it could cause serious or fatal injuries to the child.

**⚠ WARNING**

**Air bag deployment**

When children are seated in the rear outboard seats of a vehicle equipped with side and/or curtain air bags, install the Child Restraint System as far away from the door side as possible. Inflation of the side and/or curtain air bags could impact the child.

## Air bag warning light

The purpose of air bag warning light in your instrument panel is to alert you of a potential problem with your air bag system, which could include your side and/or curtain air bags used for rollover protection.



If the air bag warning light is appeared for more than 6 seconds after the ENGINE START/STOP button has been turned to the ON position, or if it appears during vehicle operation, an Supplemental Restraint System (SRS) component may not be functioning properly and you should have your vehicle checked by an authorized Kia dealer.

If any of the following conditions occur, this indicates a malfunction in the air bag system. Have an authorized Kia dealer inspect the air bag system as soon as possible.

- The light does not turn on briefly when you turn the ENGINE START/STOP button to the ON position.
- The light stays on after appearing for approximately 6 seconds.
- The light comes on while the vehicle is in motion.
- The light blinks when the ENGINE START/STOP button to the ON position.

## Supplemental Restraint System (SRS) components and functions

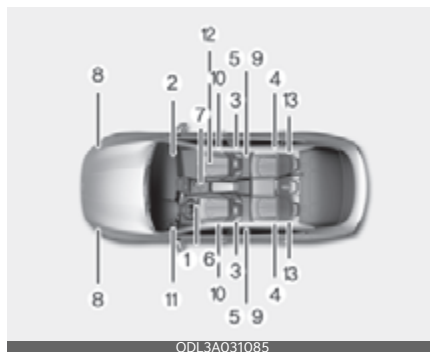

\* The actual position of SRS components may differ from the illustration.

The SRS consists of the following components:

1. Driver's front air bag module
2. Passenger's front air bag module
3. Front side air bag modules
4. Curtain air bag modules
5. Retractor pre-tensioner assemblies
6. Air bag warning light
7. SRS control module (SRSCM)
8. Front impact sensors
9. Side impact sensors
10. Side pressure sensors
11. Driver's knee air bag module
12. Occupant Detection System (ODS)  
(Front passenger's seat only)
13. Rear side air bag modules

The SRSCM continually monitors all elements while the ENGINE START/STOP button is in the ON Position or approximately within 3 minutes after ignition off to determine if a frontal, near-frontal impact or side impact is severe enough to require air bag deployment or pre-tensioner seat belt deployment.

The SRS air bag warning light on the instrument panel will appear for about 3~6 seconds after the ENGINE START/ STOP button is turned to the ON position, after which the air bag warning light should go out.

**⚠ WARNING**

If any of the following conditions occurs, this indicates a malfunction of the SRS. In this case, have the system inspected by an authorized Kia dealer.

- The light does not turn on briefly when you turn the ignition ON.
- The light stays on after appearing for approximately 6 seconds.
- The light comes on while the vehicle is in motion.
- The light blinks when the ENGINE START/STOP button is in ON position.

Driver's front air bag (1)



The air bag modules are located both in the center of the steering wheel and in the front passenger's panel above the glove box. When the SRSCM detects a sufficiently severe impact to the front of the vehicle, it will automatically deploy the front air bags.

Driver's front air bag (2)



Upon deployment, tear seams molded directly into the pad covers will separate under pressure from the expansion of the air bags. Further opening of the covers then allows full inflation of the air bags.

Driver's front air bag (3)



A fully inflated air bag, in combination with a properly worn seat belt, slows the driver's or the passenger's forward motion, reducing the risk of head and chest injury.

After complete inflation, the air bag immediately starts deflating, enabling the driver to maintain forward visibility and the ability to steer or operate other controls.

Passenger's front air bag



ODEEV058051NR

**⚠ WARNING**

**Air bag obstructions**

Do not install or place any accessories on the steering wheel, instrument panel, or on the front passenger's panel above the glove box in a vehicle. Such objects may become dangerous projectiles if the air bag deploys.

**⚠ WARNING**

**Flying objects**

Do not place any objects (an umbrella, bag, etc.) between the front door and the front seat. Such objects may become dangerous projectiles if the side airbag inflates.

- If an air bag deploys, there may be a loud noise followed by a fine dust released in the vehicle. These conditions are normal and are not hazardous - the air bags are packed in this fine powder. The dust generated during air bag deployment may cause skin or eye irritation as well as aggravate asthma for some persons. Always wash all exposed skin areas thoroughly with cold water and a mild

soap after an accident in which the air bags were deployed.

- The SRS can function only when the ENGINE START/STOP button is in the ON Position or approximately within 3 minutes after ignition off. The SRS is not working properly if any of the following situations occur:
  - the SRS airbag warning light does not appear
  - the SRS airbag warning light remains on continuously after appearing for about 3~6 seconds when the ENGINE START/STOP button is turned to the ON position or after the vehicle is in ready mode
  - the SRS airbag warning light comes on while driving

If this occurs, have your vehicle immediately inspected by an authorized Kia dealer.

**\* NOTICE**

Before you replace a fuse or disconnect a battery terminal, change the ENGINE START/STOP button to the OFF position. Never remove or replace the air bag related fuse(s) when the ENGINE START/STOP button is ON position. Failure to heed this warning will cause the SRS air bag warning light to appear.

## Occupant Detection System (ODS)

Your vehicle is equipped with an Occupant Detection System (ODS) in the front passenger's seat.



The ODS is designed to detect the presence of a properly-seated front passenger and determine if the passenger's front air bag should be enabled (may inflate) or not. Only the front passenger front air bag is controlled by the ODS. Do not put anything in front of the passenger air bag "⊗" indicator.

### Main components of the ODS

- A detection device is located within the front passenger seat cushion.
- An electronic system determines whether the passenger air bag systems should be activated or deactivated.
- An indicator light located on the overhead console which appears the words PASSENGER AIR BAG "⊗" indicates the front passenger air bag system is deactivated.
- The overhead console air bag warning light is interconnected with the ODS.

If the front passenger seat is occupied by a person that the system determines to be of appropriate size, and he/she sits properly (sitting upright with the seat-back in an upright position, centered on the seat cushion with their seat belt on, legs comfortably extended and their feet on the floor), the PASSENGER AIR BAG "⊗" indicator will turn off and the front passenger's air bag will be able to inflate, if necessary, in frontal crashes. You will find the PASSENGER AIR BAG "⊗" indicator on the overhead console. This system detects the conditions 1~4 in the following table and activates or deactivates the front passenger air bag based on these conditions.

Always be sure that you and all vehicle occupants are seated and restrained properly (sitting upright with the seat in an upright position, centered on the seat cushion, with the person's legs comfortably extended, feet on the floor, and wearing the safety belt properly) for the most effective protection by the air bag and the safety belt.

The ODS may not function properly if the passenger takes actions which can defeat the detection system. These include:

- Failing to sit in an upright position.
- Leaning against the door or center console.
- Sitting towards the sides or the front of the seat.
- Putting legs on the dashboard or resting them on other locations which reduce the passenger weight on the front seat.
- Improperly wearing the safety belt.
- Reclining the seatback.

### Conditions and operation of the front passenger ODS

Condition detected by the occupant classification system	Indicator/Warning light		Devices
	"PASSENGER AIR BAG OFF" indicator light	SRS warning light	Front passenger air bag
1. Adult*1	Off	Off	Activated
2. Child Restraint System (CRS) with child under 12 months old*2*3*4	On	Off	Deactivated
3. Unoccupied	On	Off	Deactivated
4. Malfunction in the system	Off	On	Activated

- \*1. The system judges a person of adult size as an adult. When a smaller adult sits in the front passenger seat, the system may recognize him/her as a child depending on his/her physique and posture.
- \*2. Do not allow children to ride in the front passenger seat. When a larger child who has outgrown a CRS sits in the front passenger seat, the system may recognize him/her as an adult depending upon his/her physique or sitting position.
- \*3. Never install a CRS on the front passenger seat.
- \*4. The PASSENGER AIR BAG "" indicator may turn on or off when a child above 12 months to 12 years old (with or without a CRS) sits in the front passenger seat. This is a normal condition.

3



**⚠ WARNING**

- Do not install a child restraint seat in the passenger seat when the seat is heavily soaked with any type of liquid.
- Do not alter or remodel the Occupant Detection System (ODS). This may damage the system and prevent its proper function in a collision.

**\* NOTICE**

- Do not use car seat cushions that cover up the surface of the seat and aftermarket manufactured passenger seat heaters.
- After conducting car interior cleaning using steam or detergent, the seat should be dried properly. Afterward, check for normal operation of the PASSENGER AIR BAG "OFF" and air bag warning lights.
- Any service related to the passenger seat and the ODS must be done at an authorized Kia dealership.
- After the passenger seat has been removed or installed for repair purposes, check for normal operation of the PASSENGER AIR BAG "⊗" and air bag warning lights with a person seated or not seated in the passenger seat.

**\* NOTICE**

When the PASSENGER AIR BAG "⊗" symbol appears, the passenger air bag system will not operate. The passenger air bag system will operate when necessary if the symbol is not appeared.

**\* NOTICE**

Do not modify or replace the front passenger seat. Don't place anything on or attach anything such as a blanket, front seat cover or aftermarket seat heater to the front passenger seat. This can adversely affect the Occupant Detection System.

**⚠ WARNING**

**Occupant Detection System**

Riding in an improper position adversely affects the Occupant Detection System and may result in the deactivation of the front passenger airbag. It is important for the driver to instruct the passenger as to the proper seating instructions as contained in this manual.

- Do not place a heavy load in the front passenger seatback pocket or on the front passenger seat.



## Safety features of your vehicle

- Do not place feet on the front passenger seatback.



- Never sit with hips shifted towards the front of the seat.



- Never excessively recline the front passenger seatback.



## Air bag - Advanced Supplemental Restraint System

- Never place feet on the dashboard.



- Never lean on the door or center console.



- Never sit on one side of the front passenger seat.
- Do not use car seat accessories such as thick blankets and cushions which cover up the car seat surface.

- Do not sit on the passenger seat wearing heavily padded clothes such as ski wear and hip protector.

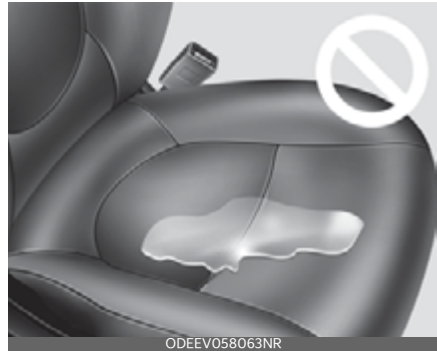

- Do not place electronic devices such as laptops, DVD player, or conductive materials such as water bottles on the passenger seat.
- Do not use electronic devices such as laptops and satellite radios which use inverter chargers.



- Wet passenger seat:  
Do not spill liquid in the passenger seat. Spilled liquid on the passenger seat may cause the air bag warning light to appear or malfunction. If any liquid is spilled, make sure the seat has been completely dried before driving the vehicle.

When an adult is seated in the front passenger seat, if the PASSENGER AIR BAG "⊗" indicator is on, change the ENGINE START/STOP button to the OFF position and ask the passenger to sit properly (sitting upright with the seatback in an upright position, centered on the seat cushion with their seat belt on, legs comfortably extended and their feet on the floor). Restart the vehicle and have the person remain in that position. This will allow the system to detect the person and to enable the passenger air bag.

If the PASSENGER AIR BAG "⊗" indicator is still on, ask the passenger to move to the rear seat.

**⚠ WARNING****PASSENGER AIR BAG "⊗" light**

Do not allow an adult passenger to ride in the front seat when the PASSENGER AIR BAG "⊗" indicator is appeared, because the air bag will not deploy in the event of a crash. The driver must instruct the passenger to reposition himself in the seat. Failure to properly position yourself may lead to air bag deactivation resulting in air bag non-deployment in a collision. If the PASSENGER AIR BAG "⊗" indicator remains appeared after the passenger repositions themselves properly and the car is restarted, it is recommended that passenger move to the rear seat because the passenger's front air bag will not deploy.

**\* NOTICE**

The PASSENGER AIR BAG "⊗" indicator does not appear if the front passenger seat is occupied, the occupant detection sensor will then classify the front passenger after several more seconds. Also, if the ENGINE START/STOP button is turned to the ON position when about 3 minutes have elapsed since the vehicle is in OFF position.

- Even though your vehicle is equipped with the Occupant Detection System, never install a Child Restraint System in the front passenger's seat. A deploying air bag can forcefully strike a child resulting in serious injuries or death.

Any child age 13 and under should ride in the rear seat. Children too large for child restraints should use the available lap/shoulder belts. No matter what type of crash, children of all ages are safer when restrained in the rear seat.

If the ODS is not working properly, the Supplemental Restraint System (SRS) air bag warning light on the instrument panel will appear because the passenger's front air bag is connected with the ODS. If there is a malfunction of the ODS the PASSENGER AIRBAG "⊗" indicator will not appear. In this case, the passenger's front airbag will inflate in frontal impact crashes even if there is no occupant in the front passenger seat.

**Driver's and passenger's front air bag**

Your vehicle is equipped with an advanced supplemental restraint (air bag) system and lap/shoulder belts at both the driver and passenger seating position.

Driver's front air bag



Driver's knee air bag



Passenger's front air bag



The indication of the system's presence are the letters "AIR BAG" located on the air bag pad cover and driver's knee area on the steering wheel and the passenger's side front panel pad above the glove box.

The Supplemental Restraint System (SRS) consists of air bags installed under the pad covers in the center of the steering wheel and the passenger's side front panel above the glove box.

The purpose of the SRS is to provide the vehicle's driver and/or the front passenger with additional protection than that offered by the seat belt system alone in case of a frontal impact of sufficient severity. The SRS uses sensors to gather

information about the driver's and front passenger's seat belt usage and impact severity.

The seat belt buckle sensor determines if the front passenger's seat belt is fastened.

These sensors provide the ability to control the SRS deployment based on whether or not the seat belts are fastened, and how severe the impact is.

The advanced SRS offers the ability to control the air bag inflation with two levels. A first stage level is provided for moderate-severity impacts. A second stage level is provided for more severe impacts.

According to the impact severity and seat belt usage, the SRS Control Module (SRSCM) controls the air bag inflation. Failure to properly wear seat belts can increase the risk or severity of injury in an accident.

Additionally, your vehicle is equipped with an Occupant Detection System (ODS) in the front passenger's seat. The ODS detects the presence of a passenger in the front passenger's seat and will turn off the front passenger's air bag under certain conditions. For more detail, see "Occupant Detection System (ODS)" on page 3-40.

**⚠ WARNING**

Modification to the seat structure can cause the air bag to deploy at a different level than should be provided.

Manufacturers are required by government regulations to provide a contact point concerning modifications to the vehicle for persons with disabilities, which modifications may affect the vehicle's advanced air bag system. That contact is Kia's toll-free Customer

Assistance center at 1-800-333-4Kia(U.S. only). However, Kia does not endorse nor will it support any changes to any part or structure of the vehicle that could affect the advanced air bag system, including the ODS.

**⚠ WARNING**

**Replacement/modifications**

The front passenger seat, dashboard or door should not be replaced except by an authorized Kia dealer using original Kia parts designed for this vehicle and model. Any other such replacement or modification could adversely affect the operation of the Occupant Detection System and your advanced air bags.

Advanced air bags are combined with pre-tensioner seat belts to help provide enhanced occupant protection in frontal crashes. Front air bags are not intended to deploy in collisions in which sufficient protection can be provided by the seat belt.

**\* NOTICE**

Air bags can only be used once - have an authorized Kia dealer replace the air bag immediately after deployment.

Front air bags are not intended to deploy in side-impact, rear-impact or rollover crashes. However, when frontal deployment threshold is satisfied at side-impact, front air bags may deploy. In addition, front air bags will not deploy in frontal crashes below the deployment threshold.

**⚠ WARNING**

**SRS wiring**

Do not tamper with or disconnect SRS wiring or other components of the SRS system. Doing so could result in injury, due to accidental deployment of the air bags or by rendering the SRS inoperative.

**⚠ WARNING**

**No attaching objects**

No objects (such as crash pad cover, cellular phone holder, cup holder, perfume or stickers) should be placed over or near the air bag modules on the steering wheel, instrument panel, windshield glass, and the front passenger's panel above the glove box. Such objects could cause harm if the vehicle is in a crash severe enough to cause the air bags to deploy.

Do not place any objects over the air bag or between the air bag and yourself.

Additionally, never place or insert any object into any small opening near side airbag labels attached to the vehicle seats.

When the air bag deploys, the object may affect the deployment and result in unexpected accident or bodily harm.

## Side air bag

Your vehicle is equipped with a side air bag in each front seat.

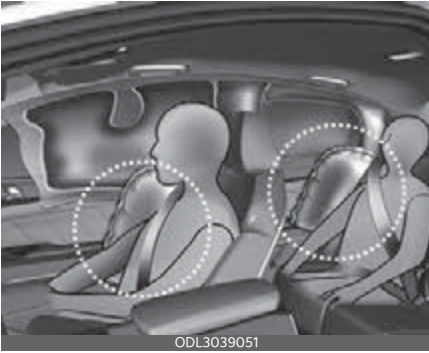

Front seat



Rear seat



\* The actual air bags in the vehicle may differ from the illustration.

The purpose of the air bag is to provide the vehicle's driver and/or the front passenger with additional protection than that offered by the seat belt alone.

- The side air bags are designed to deploy during certain side-impact collisions, depending on the crash severity of the impact
- The side air bags may deploy on the side of the impact or on both sides.
- The side and/or curtain air bags on both sides of the vehicle will deploy if a rollover or possible rollover is detected.
- The side air bags are not designed to deploy in all side impact or rollover situations.

### **⚠ WARNING**

#### **Unexpected deployment**

Avoid impact to the side impact airbag sensor when the ENGINE START/STOP button is ON to prevent unexpected deployment of the side air bag.

- The side air bag is supplemental to the driver's and the passenger's seat belt systems and is not a substitute for them. Therefore your seat belts must be worn at all times while the vehicle is in operation.
- For best protection from the side air bag system and to avoid being injured by the deploying side air bag, both front seat occupants should sit in an upright position with the seat belt properly fastened. The driver's hands should be placed on the steering wheel at the 9:00 and 3:00 positions. The passenger's arms and hands should be placed on their laps.



**⚠ WARNING**

**Deployment**

Do not install any accessories including seat covers, on the side or near the side air bag as this may affect the deployment of the side air bags.

- If the seat or seat cover is damaged, have the vehicle checked and repaired by an authorized Kia dealer. Inform the dealer that your vehicle is equipped with side air bags and an Occupant Detection System (ODS).

**⚠ WARNING**

**Flying objects**

Do not place any objects (an umbrella, bag, etc.) between the front door and the front seat. Such objects may become dangerous projectiles if the side airbag inflates.

**⚠ WARNING**

**No attaching objects**

- Do not place any objects over the air bag or between the air bag and yourself. Also, do not attach any objects around the area the air bag inflates such as the door, side door glass, front and rear pillar.
- Do not put any objects between the side airbag label and seat cushion. It could cause harm if the vehicle is in a crash severe enough to cause the air bags to deploy.
- Never place or insert any object into any small opening near side airbag labels attached to the vehicle seats. When the air bag deploys, the object may affect the deployment and result in unexpected accident or bodily harm.

- Do not install any accessories on the side or near the side air bags.

**Curtain air bag**

Curtain air bags are located along both sides of the roof rails above the front and rear doors.



\* The actual air bags in the vehicle may differ from the illustration.

They are designed to help protect occupants in certain side impacts and to help prevent them from ejecting out of the vehicle as a result of a rollover, especially when the seat belts are also in use.

- The curtain air bags are designed to deploy during certain side impact collisions, depending on the severity of impact. However, when side deployment



ment threshold is satisfied at front-impact, side air bags may deploy.

- The curtain air bags may deploy on the side of the impact or on both sides.
- Also, the curtain air bags on both sides of the vehicle will deploy in certain rollover situations.
- The curtain air bags are not designed to deploy in all side impact or rollover situations.

Do not allow the passengers to lean their heads or bodies against the doors, put their arms on the doors, stretch their arms out of the window or place objects between the doors and passengers when they are seated on seats equipped with side impact and/or curtain air bags.

#### **\* NOTICE**

Never try to open or repair any components of the side and curtain air bag system. This should only be done by an authorized Kia dealer.

#### **⚠ WARNING**

##### **No attaching objects**

- Do not place any objects over the air bag. Also, do not attach any objects around the area the air bag inflates such as the door, side door glass, front and rear pillar, roof side rail.
- Do not hang hard, breakable, or heavy objects on the coat hooks for safety reasons.

### Air bag collision sensors

The air bag collision sensors are located in the following positions.

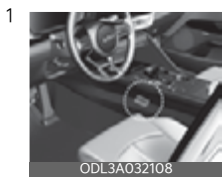

\* The actual shape and position of sensors may differ from the illustration.

1. Supplemental Restraint System (SRS) control module/rollover sensor
2. Front impact sensor
3. Side pressure sensor
4. Side impact sensor

**⚠ WARNING**

**Air bag sensors**

- Do not hit or allow any objects to impact the locations where air bags or sensors are installed.

This may cause unexpected air bag deployment, which could result in serious personal injury or death.

- If the installation location or angle of the sensors is altered in any way, the air bags may deploy when they should not or they may not deploy when they should.

Therefore, do not try to perform maintenance on or around the air bag sensors. Have the vehicle checked and repaired by an authorized Kia dealer.

- Do not arbitrarily touch the front impact sensor. When the angle of the sensor is changed, the air bag system may malfunction.

Problems may arise if the sensor installation angles are changed due to the deformation of the front bumper, front end module, body or front doors where side collision sensors are installed. Have the vehicle checked and repaired by an authorized Kia dealer.

Installing bumper guards (or side step or running board) or replacing a bumper (or front door module) with non-genuine parts may adversely affect your vehicle's collision and air bag deployment performance.

Kia Genuine bumper guards/bumpers are parts we guarantee for quality and performance.

**Why didn't my air bag go off in a collision? (Inflation and non-inflation conditions of the air bag)**

There are many types of accidents in which the air bag would not be expected to provide additional protection.

These include rear impacts, second or third collisions in multiple impact accidents, as well as low speed impacts.

**Air bag inflation conditions**

**Front air bags**



Front air bags are designed to inflate in a frontal collision depending on several factors, including the severity of impact of the front collision.

### Side and/or curtain air bags



\* The actual air bags in the vehicle may differ from the illustration.

Side and/or curtain air bags are designed to inflate when an impact is detected by side collision sensors depending on several factors, including the severity of impact resulting from a side impact collision.

Also, the side and curtain air bags are designed to inflate when a rollover is detected by a rollover sensor.

Although the front air bags (driver's and front passenger's air bags) are primarily designed to inflate in frontal collisions, they may inflate in other types of collisions if the front impact sensors detect a sufficient frontal force in another type of impact.

Similarly, although side and curtain air bags are designed to inflate in certain side impact collisions, they may inflate in other types of collisions where a side force is detected by the sensors. For instance, side air bag and/or curtain air bags may inflate if rollover sensors indicate the possibility of a rollover occurring (even if none actually occurs) or in other situations, including when the vehicle is tilted while being towed.

Even if side and/or curtain air bags do not provide impact protection in a rollover, they will deploy to prevent ejection of occupants, especially those who are restrained with seat belts.

If the vehicle chassis is impacted by bumps or objects on unimproved roads, the air bags may deploy. Drive carefully on unimproved roads or on surfaces not designed for vehicle traffic to prevent unintended air bag deployment.

### Air bag non-inflation conditions

- Air bags may not deploy in certain low-speed collisions where the air bag would not add any benefit beyond the protection already offered by the seat belts.



- Front air bags are not designed to inflate in rear collisions, because

occupants are moved backward by the force of the impact. In this case, inflated air bags would not be able to provide any additional benefit.



- Front air bags may not inflate in side impact collisions, because passengers move in the direction of the collision. Thus, in side impacts, frontal air bag deployment would not provide additional occupant protection.



- In an angled collision, the force of impact may direct the occupants in a direction where the air bags would not be able to provide any additional benefit, and thus the sensors may not deploy any air bags.

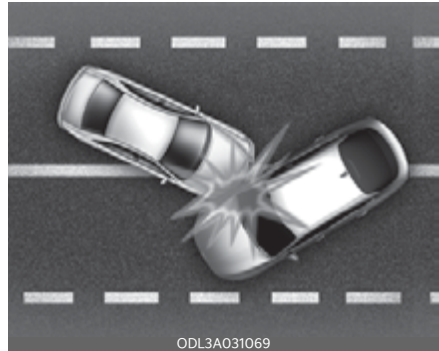

- Just before impact, drivers often brake heavily. Such heavy braking lowers the front portion of the vehicle causing it to "ride" under a vehicle with a higher ground clearance. Air bags may not inflate in this "under-ride" situation because deceleration forces that are detected by sensors may be significantly reduced by such "under-ride" collisions.



- Front air bags may not inflate in all rollover accidents when the SRS Control Module (SRSCM) indicates that the front air bag deployment would not provide additional occupant protection.

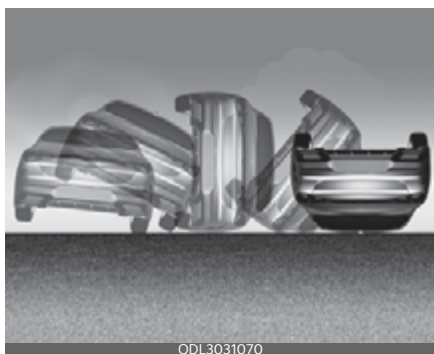

ODL3031070

- Air bags may not inflate if the vehicle collides with an object such as a utility pole or tree. This is because the point of impact is concentrated in one area and the full force of the impact is not delivered to the sensors.



ODL3A031071

### Supplemental Restraint System (SRS) care

The Supplemental Restraint System (SRS) is virtually maintenance-free and so there are no parts you can safely service by yourself.

If the SRS air bag warning light does not appear, or continuously remains on, have your vehicle immediately inspected by an authorized Kia dealer.

Any work on the SRS, such as removing, installing, repairing, or any work on the steering wheel, the front passenger's

panel, front seats and roof rails must be performed by an authorized Kia dealer. Improper handling of the SRS may result in serious personal injury.

For cleaning the air bag pad covers, use only a soft, dry cloth or one which has been moistened with plain water. Solvents or cleaners could adversely affect the air bag covers and proper deployment of the system.

If components of the air bag system must be discarded, or if the vehicle must be scrapped, certain safety precautions must be observed. An authorized Kia dealer knows these precautions and can give you the necessary information. Failure to follow these precautions and procedures could increase the risk of bodily injury.

#### **⚠ WARNING**

##### **Tampering with SRS**

Do not tamper with or disconnect SRS wiring or other components of the SRS system. Doing so could result in the accidental inflation of the air bag or render the SRS inoperative.

#### **⚠ WARNING**

##### **Towing vehicle**

Always have the ignition off when your vehicle is being towed. The side air bags may inflate if the vehicle is tilted such as when being towed because of the roll-over sensors in the vehicle.

### **Additional safety precautions**

- **Never let passengers ride in the cargo area or on top of a folded-down back seat.** All occupants should sit upright, fully back in their seats with their seat belts on and their feet on the floor.

- **Passengers should not move out of or change seats while the vehicle is moving.** A passenger who is not wearing a seat belt during a crash or emergency stop can be thrown against the inside of the vehicle, against other occupants, or out of the vehicle.
- **Each seat belt is designed to restrain one occupant.** If more than one person uses the same seat belt, they could be seriously injured or killed in a collision.
- **Do not use any accessories on seat belts.** Devices claiming to improve occupant comfort or reposition the seat belt can reduce the protection provided by the seat belt and increase the chance of serious injury in a crash.
- **Passengers should not place hard or sharp objects between themselves and the air bags.** Carrying hard or sharp objects on your lap or in your mouth can result in injuries if an air bag inflates.
- **Keep occupants away from the air bag covers.** All occupants should sit upright, fully back in their seats with their seat belts on and their feet on the floor. If occupants are too close to the air bag covers, they could be injured if the air bags inflate.
- **Do not attach or place objects on or near the air bag covers.** Any object attached to or placed on the front or side air bag covers could interfere with the proper operation of the air bags.
- **Do not modify the front seats.** Modification of the front seats could interfere with the operation of the supplemental restraint system sensing components or side air bags.
- **Do not place items under the front seats.** Placing items under the front seats could interfere with the operation of the supplemental restraint system sensing components and wiring harnesses.
- **Never hold an infant or child on your lap.** The infant or child could be seriously injured or killed in the event of a crash. All infants and children should be properly restrained in appropriate child safety seats or seat belts in the rear seat.

### **WARNING**

- Sitting improperly or out of position can cause occupants to be shifted too close to a deploying air bag, strike the interior structure or be thrown from the vehicle resulting in serious injury or death.
- Always sit upright with the seatback in an upright position, centered on the seat cushion with your seat belt on, legs comfortably extended and your feet on the floor.

### **Adding equipment to or modifying your air bag-equipped vehicle**

If you modify your vehicle by changing your vehicle's frame, bumper system, front end or side sheet metal or ride height, this may affect the operation of your vehicle's air bag system.

### **Air bag warning label**

Air bag warning labels, some required by the U.S. National Highway Traffic Safety Administration (NHTSA, U.S. only), are attached to the sun visor to alert the driver and passengers of potential risks of the air bag system.



ODL3A032100C





<b>Keys</b> .....	<b>4-6</b>
• Battery replacement .....	4-6
• Remote key.....	4-7
• Smart key.....	4-9
<b>Immobilizer System</b> .....	<b>4-12</b>
• Folding key immobilizer system.....	4-12
• Smart key immobilizer system.....	4-12
<b>Theft-alarm system</b> .....	<b>4-13</b>
<b>Door locks</b> .....	<b>4-16</b>
• With the smart key .....	4-16
• With the mechanical key.....	4-16
• Operating door locks from inside the vehicle .....	4-18
• Door lock/unlock features.....	4-20
• Child-protector rear door lock.....	4-20
• Electronic child safety lock system .....	4-21
• In case of an emergency .....	4-22
• Rear Occupant Alert (ROA) system .....	4-22
<b>Driver position memory system</b> .....	<b>4-24</b>
• Storing memory positions .....	4-24
• Recalling memory positions .....	4-24
• Driver position memory system reset.....	4-25
• Easy access function .....	4-25
<b>Trunk</b> .....	<b>4-26</b>
• Opening the trunk .....	4-26
• Closing the trunk.....	4-27
• Emergency trunk safety release .....	4-27
<b>Smart Trunk</b> .....	<b>4-28</b>
• How to use the Smart Trunk.....	4-28
• How to deactivate the Smart Trunk function using the smart key.....	4-30

# 4 Features of your vehicle

• Detecting area .....	4-30
<b>Windows .....</b>	<b>4-32</b>
• Window opening and closing .....	4-33
• Power window lock button .....	4-35
<b>Hood .....</b>	<b>4-36</b>
• Opening the hood.....	4-36
• Hood open warning .....	4-37
• Closing the hood .....	4-37
<b>Fuel filler door .....</b>	<b>4-38</b>
• Opening the fuel filler door .....	4-38
• Closing the fuel filler door.....	4-39
<b>Panoramic sunroof .....</b>	<b>4-42</b>
• Power sunshade.....	4-43
• Tilt open/close .....	4-43
• Slide open/close .....	4-43
• Automatic reversal .....	4-44
• Resetting the sunroof.....	4-45
• Sunroof open warning.....	4-45
<b>Steering wheel .....</b>	<b>4-46</b>
• Motor Driven Power Steering (MDPS) .....	4-46
• Tilt & telescopic steering wheel .....	4-47
• Heated steering wheel.....	4-47
• Horn .....	4-48
<b>Mirrors .....</b>	<b>4-49</b>
• Inside rear view mirror.....	4-49
• Outside rear view mirror.....	4-60
<b>Instrument cluster.....</b>	<b>4-63</b>
• Adjusting instrument cluster illumination .....	4-64
• Gauges.....	4-64
• Transmission shift indicator .....	4-67

<b>LCD display</b> .....	<b>4-68</b>
• LCD display modes.....	4-69
• Trip information (trip computer) .....	4-78
• Service mode .....	4-80
• LCD display messages.....	4-81
<b>Warning and indicator lights</b> .....	<b>4-84</b>
• Warning lights.....	4-84
• Indicator lights.....	4-90
<b>Head-Up Display (HUD)</b> .....	<b>4-93</b>
• Head-Up Display Information.....	4-94
• Head-Up Display Setting .....	4-94
<b>Lighting</b> .....	<b>4-95</b>
• Battery saver function.....	4-95
• Headlamp delay function.....	4-95
• Daytime Running Light (DRL).....	4-95
• Lighting control .....	4-96
• Operating high beam .....	4-97
• Operating turn signals and lane change signals .....	4-98
• Operating front fog light .....	4-99
• High Beam Assist (HBA).....	4-99
<b>Wipers and washers</b> .....	<b>4-102</b>
• Operating windshield washers.....	4-103
<b>Welcome system</b> .....	<b>4-104</b>
<b>Interior lights</b> .....	<b>4-105</b>
• Automatic turn off function.....	4-105
• Map lamp.....	4-105
• Room lamp.....	4-106
• Luggage room lamp .....	4-106
• Vanity mirror lamp .....	4-107
<b>Climate control system</b> .....	<b>4-107</b>
• System operation .....	4-107

# 4 Features of your vehicle

• Climate control air filter.....	4-109
• Air conditioning refrigerant label.....	4-109
• Checking the amount of air conditioner refrigerant and compressor lubricant.....	4-110
<b>Automatic climate control system.....</b>	<b>4-111</b>
• Heating and air conditioning automatically.....	4-112
• Heating and air conditioning manually.....	4-114
• Automatic Air Ventilation.....	4-118
• Active upon Washer Fluid Use.....	4-119
• Sunroof inside air recirculation.....	4-119
<b>Windshield defrosting and defogging.....</b>	<b>4-120</b>
• Defogging inside windshield with automatic climate control.....	4-120
• Defrosting outside windshield with automatic climate control.....	4-121
• Auto defogging system (only for automatic climate control system).....	4-121
• Defroster.....	4-122
• Front glass heater.....	4-122
• Defogging logic.....	4-123
<b>Storage compartment.....</b>	<b>4-124</b>
• Center console storage.....	4-124
• Glove box.....	4-124
• Luggage net holder.....	4-124
<b>Interior features.....</b>	<b>4-125</b>
• Cup holder.....	4-125
• Seat warmer.....	4-126
• Air ventilation seat.....	4-128
• Sun visor.....	4-128
• USB charger.....	4-129
• Power outlet.....	4-130
• Wireless smart phone charging system.....	4-131
• Coat hook.....	4-133
• Floor mat anchor(s).....	4-134

<b>Infotainment system .....</b>	<b>4-135</b>
• Antenna .....	4-135
• USB port .....	4-135
• How vehicle radio works.....	4-136
<b>Declaration of Conformity .....</b>	<b>4-138</b>

## Features of your vehicle

### Keys

#### **WARNING**

Never leave the keys in your vehicle with unsupervised children. Leaving children unattended in a vehicle with a manual ignition key or a smart key is dangerous. Children copy adults and they could place the key in the ignition switch or press the start button. The key would enable children to operate power windows or other controls, or even make the vehicle move, which could result in serious bodily injury or death.

#### Record your key number



The key code number is stamped on the key code tag attached to the key set. Should

you lose your keys, this number will enable an authorized Kia dealer to duplicate the keys easily. Remove the key code tag and store it in a safe place. Also, record the key code number and keep it in a safe and handy place, but not in the vehicle.

#### **WARNING**

#### Aftermarket keys

Use only Kia original parts for the ignition key in your vehicle. If an aftermarket key is used, the ignition switch or ENGINE START/STOP button may not return to ON after START. If this happens, the starter will continue to operate causing possible fire due to excessive current in the wiring.

#### Battery replacement

The remote key or smart key uses a 3 volt lithium battery which will normally last for several years.



If you are unsure how to use or replace the battery, contact an authorized Kia dealer.

1. Detach mechanical key from your remote key or smart key.
2. Pry open the key cover.
3. Replace the battery with a new CR2032 battery. When replacing the battery, make sure the battery position is correct.
4. Install the battery in the reverse order of removal.

For remote key or smart key replacement, visit an authorized Kia dealer.

The remote key or smart key is designed to give you years of use, but it can malfunction if exposed to moisture or static electricity. If you are unsure how to use or replace the battery, contact an authorized Kia dealer.

Using the wrong battery can cause the remote key or smart key to malfunction. Be sure to use the correct battery.



An inappropriately disposed battery can be harmful to the environment and human

health. Dispose the battery according to your local law(s) or regulation.

### **⚠ WARNING**

#### **THIS PRODUCT CONTAINS A BUTTON BATTERY**

If swallowed, a lithium button battery can cause severe or fatal injuries within 2 hours.

Keep batteries out of reach of children. If you think batteries may have been swallowed or placed inside any part of the body, seek immediate medical attention.

### **⚠ CAUTION**

#### **Remote key or smart key damage**

The remote key or smart key can malfunction if dropped, exposed to moisture, static electricity, heat or direct sunlight.

#### **This device complies with Part 15 of the FCC rules.**

Operation is subject to the following two conditions:

1. This device may not cause harmful interference, and
2. This device must accept any interference received, including interference that may cause undesired operation.

### **\* NOTICE**

Changes or modifications not expressly approved by the party responsible for compliance could void the user's authority to operate the equipment. If the smart key is inoperative due to changes or modifications not expressly approved by the party responsible for compliance,

it will not be covered by your manufacturer's vehicle warranty.

#### **Remote key (if equipped)**

With a remote key, you can lock or unlock the door and trunk.



4

#### **Lock (1)**

All doors are locked if the lock button is pressed. If all doors are closed, the hazard warning lights will blink and the chime will sound once to indicate that all doors are locked.

Also, if the lock button is pressed once more within 4 seconds, the hazard warning lights will blink and the chime will sound once to confirm that the door is locked.

However, if any door remains open, the hazard warning lights (and/or the chime) will not operate. But if all doors are closed after the lock button is pressed, the hazard warning lights will blink once.

#### **Unlock (2)**

The driver's door is unlocked if the unlock button is pressed once. The hazard warning lights will blink twice to indicate that the driver's door is unlocked.



All doors are unlocked if the unlock button is pressed once more within 4 seconds. The hazard warning lights will blink and the chime will sound twice again to indicate that all doors are unlocked. After pressing this button, the doors will lock automatically unless you open any door within 30 seconds.

If you attempt to lock or unlock the door by pressing the door lock/unlock button in any of the following states, the door will not be locked or unlocked.

- When you want to lock or unlock the door in the ACC or ON state.
- When you want to lock a door in a car with one or more doors open.

Depending on the vehicle, the driver can turn off or set the 2-press unlock setting function. For more information, see "User Settings mode" on page 4-72.

#### \* NOTICE

If the remote key is inoperative due to exposure to water or liquids, it will not be covered by your manufacturer's vehicle warranty.

### Panic alarm (3)

The horn sounds and the hazard warning lights blink for about 30 seconds if this button is pressed for more than 0.5 seconds. To stop the horn and lights, press any button on the transmitter.

### Mechanical key

If the remote key does not operate normally, you can lock or unlock the door by using the mechanical key.



To unfold the key, press the release button then the key will unfold automatically.

To fold the key, fold the key manually while pressing the release button.

#### ⚠ CAUTION

#### Key button operation

Do not fold the key without pressing the release button. This may damage the key.

### Transmitter precautions

The transmitter will not work if any of the following occurs:

- The ignition key is in the ignition switch.
- You exceed the operating distance limit. (about 32 ft [10 m]).
- The battery in the transmitter is weak.
- Other vehicles or objects may be blocking the signal.
- The weather is extremely cold.
- The remote key is close to a radio transmitter such as a radio station or an airport which can interfere with normal operation of the transmitter.

When the transmitter does not work properly, open and close the door with the ignition key. If you have a problem with the remote key, contact an authorized Kia dealer.

- If the transmitter is in close proximity to your cell phone or smart phone, the signal from the transmitter could be blocked by normal operation of your cell phone or smart phone. This is especially important when the phone is active such as making calls, receiving calls, text messaging, and/or sending/receiving emails. Avoid placing the remote key and your cell phone or smart phone in the same pants or jacket pocket and maintain adequate distance between the two devices.

### **⚠ CAUTION**

#### **Transmitter**

Keep the transmitter away from water or any liquid as, it can become damaged and not function properly.

### **\* NOTICE**

If the remote key is inoperative due to exposure to water or liquids, it will not be covered by your manufacturer's vehicle warranty.

## **Smart key**

With a smart key, you can lock or unlock a door and even start the engine without inserting the key.



4

## **Lock (1)**

All doors are locked if the lock button is pressed. If all doors are closed, the hazard warning lights will blink and the chime will sound once to indicate that all doors are locked.

Also, if the lock button is pressed once more within 4 seconds, the hazard warning lights will blink and the chime will sound once to confirm that the door is locked.

However, if any door remains open, the hazard warning lights (and/or the chime) will not operate. But if all doors are closed after the lock button is pressed, the hazard warning lights will blink once.

## **Unlock (2)**

The driver's door is unlocked if the unlock button is pressed once. The hazard warning lights will blink twice to indicate that the driver's door is unlocked.

All doors are unlocked if the unlock button is pressed once more within 4 seconds. The hazard warning lights will

blink and the chime will sound twice again to indicate that all doors are unlocked. After pressing this button, the doors will lock automatically unless you open any door within 30 seconds.

If you attempt to lock or unlock the door by pressing the door lock/unlock button in any of the following states, the door will not be locked or unlocked.

- When you want to lock or unlock the door in the ACC or ON state.
- When you want to lock a door in a car with one or more doors open.

For some vehicles, you can remove or set the 2-press unlock (press it twice to unlock). For more information, see "User Settings mode" on page 4-72

**\* NOTICE**

If the smart key is inoperative due to exposure to water or liquids, it will not be covered by your manufacturer's vehicle warranty.

**Trunk open (3)**

The trunk is opened if the button is pressed for more than 1 second.

**Panic alarm (4)**

The horn sounds and the hazard warning lights blink for about 30 seconds if this button is pressed for more than 0.5 seconds. To stop the horn and lights, press any button on the transmitter.

**Remote start (5) (if equipped)**

You can start the vehicle using the remote start button (5) of the smart key. To start the vehicle remotely:

- Lock the doors by pressing the door lock button (1) within 32 ft (10 m) distance from the vehicle.
- Press the remote start button for over 2 seconds within 4 seconds after locking the doors.

Press the remote start button once to turn off the vehicle.

If no further action for operating/driving the vehicle is taken, the vehicle will be turned off 10 minutes after starting the vehicle remotely.

**Start-up (if equipped)**

You can start the vehicle without inserting the key.

\* For more information, refer to "ENGINE START/STOP button" on page 5-5.

**Mechanical key**

If the smart key does not operate normally, you can lock or unlock the door by using the mechanical key.



To remove the mechanical key, press and hold the release button (1) and remove the mechanical key (2).

To reinstall the mechanical key, put the key into the hole and push it until a "click" sound is heard.

## Smart key precautions

The smart key may not work if any of the following occur:

- The smart key is close to a radio transmitter such as a radio station or an airport which can interfere with normal operation of the smart key.
- The smart key is near a mobile two-way radio system or a cellular phone.
- Another vehicle's smart key is being operated close to your vehicle.

When the smart key does not work correctly, open and close the door with the mechanical key and contact an authorized Kia dealer.

If the smart key is in close proximity to your cell phone or smart phone, the signal from the smart key could be blocked by normal operation of your cell phone or smart phone. This is especially important when the phone is active, such as when making calls, receiving calls, text messaging, and/or sending/receiving emails. Avoid placing the smart key and your cell phone or smart phone in the same pants or jacket pocket and maintain adequate distance between the two devices.

### CAUTION

#### Transmitter

Keep the transmitter away from water or any liquid, as it can become damaged and not function properly.

### NOTICE

#### • Loss of the smart key

A maximum of 2 smart keys can be registered to a single vehicle.

If you happen to lose your smart key, you will not be able to start the vehicle. You should immediately take the

vehicle and remaining key to your authorized Kia dealer (tow the vehicle, if necessary) to protect it from potential theft.

- If the smart key is inoperative due to exposure to water or liquids, it will not be covered by your manufacturer's vehicle warranty.
- To prevent the electronic key from becoming damaged by magnetic fields, do not leave it near the following electrical appliances:
  - TVs
  - Personal computers
  - Cellular phones, cordless phones and battery chargers
  - Table lamps
  - Induction cookers
- If you have to leave the vehicle's key with a parking attendant, remove the mechanical key for your own use and provide the attendant with the electronic key only.
- When bringing a smart key onto an airplane, make sure you do not press any button on the key while inside the cabin. If you are carrying the key in your bag etc., make sure that the buttons cannot be pressed accidentally. If you press a button, the key may emit radio waves that could interfere with the operation of the aircraft.

## Immobilizer System

### Folding key immobilizer system

Your immobilizer system is comprised of a small transponder in the ignition key and electronic devices inside the vehicle. With the immobilizer system, whenever you insert your ignition key into the ignition switch and turn it to ON, it checks and determines and verifies that the ignition key is valid.

If the key is determined to be valid, the engine will start.

If the key is determined to be invalid, the engine will not start.

### Deactivating the immobilizer system

Insert the ignition key into the key cylinder and turn it to the ON position.

### Activating the immobilizer system

Turn the ignition key to the OFF position. The immobilizer system activates automatically. Without a valid ignition key for your vehicle, the engine will not start.

Your Immobilizer password is a customer unique password and should be kept confidential. Do not leave this number anywhere in your vehicle.

#### \* NOTICE

Keep each key separately in order to avoid a starting malfunction.

#### \* NOTICE

In order to prevent theft of your vehicle, do not leave spare keys anywhere in your vehicle. Your immobilizer password is a customer unique password should

be kept confidential. Do not leave this number anywhere in your vehicle.

#### \* NOTICE

- Do not put metal accessories near the ignition switch.
- Metal accessories may interrupt the transponder signal and may prevent the engine from being started.

#### \* NOTICE

If you need additional keys or lose your keys, consult an authorized Kia dealer.

#### ⚠ CAUTION

#### Immobilizer damage

Do not expose your immobilizer system to moisture, static electricity or rough handling. This may damage your immobilizer.

### Smart key immobilizer system

The immobilizer system protects your vehicle from theft. If an improperly coded key (or other device) is used, the vehicle's power system is disabled.

When the ENGINE START/STOP button is placed in the ON position, the immobilizer system indicator should come on briefly, then go off. If the indicator starts to blink, the system does not recognize the coding of the key.

Place the ENGINE START/STOP button in the OFF position, then place the ENGINE START/STOP button in the ON position again.

If the system repeatedly does not recognize the coding of the key, it is recommended that you contact your Kia dealer.

Do not attempt to alter this system or add other devices to it. Electrical problems could result that may make your vehicle inoperable.

### \* NOTICE

When starting the vehicle, do not use the key with other immobilizer keys around. Otherwise, the vehicle may not start or may stop soon after it starts. Keep each key separate in order to avoid a starting malfunction.

### \* NOTICE

If you need additional keys or lose your keys, contact an authorized Kia dealer.

## This device complies with Part 15 of the FCC rules.

Operation is subject to the following two conditions:

1. This device may not cause harmful interference, and
2. This device must accept any interference received, including interference that may cause undesired operation.

### \* NOTICE

Changes or modifications not expressly approved by the party responsible for compliance could void the user's authority to operate the equipment. If the smart key is inoperative due to changes or modifications not expressly approved by the party responsible for compliance, it will not be covered by your manufacturer's vehicle warranty.

## Theft-alarm system

This system is designed to provide protection from unauthorized entry into the vehicle.

This system is operated in three stages:

1. Armed stage
2. Theft-alarm stage
3. Disarmed stage

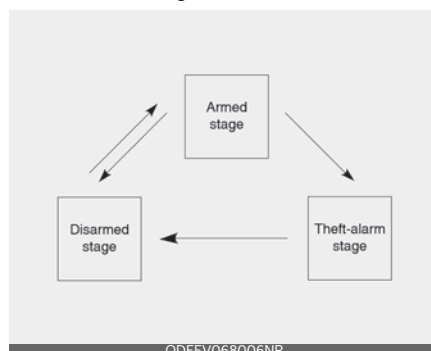

This system is operated in three stages: the first is the "Armed" stage, the second is the "Theft-alarm" stage, and the third is the "Disarmed" stage. If triggered, the system provides an audible alarm with blinking of the hazard warning lights.

### ⚠ CAUTION

Do not attempt to alter this system or add other devices to it.

## Armed stage

### Using the smart key

Park the vehicle and stop the engine. Arm the system as described below.

1. Turn off the engine.
2. Make sure that all doors, the hood and trunk are closed and latched.
3. Lock the doors by pressing the button of the front outside door handle with the smart key in your possession. After completion of the steps above, the hazard warning lights will operate once to indicate that the system is armed. If any door (or trunk) or hood remains open, the hazard warning lights and the chime will not operate and the theft-alarm will not arm. If all doors and trunk and hood are closed after the lock button is pressed, the hazard warning lights blink once. The system can also be armed by locking the doors with the key from the front doors; however, the hazard warning lights will not blink using this method.
4. Lock the doors by pressing the lock button on the smart key. After completion of the steps above, the hazard warning lights will operate once to indicate that the system is armed.

### Using the folding key

Park the vehicle and stop the engine. Arm the system as described below.

1. Turn off the engine and remove the ignition key from the ignition switch.
2. Make sure that all doors (and trunk) and the engine hood are closed and latched.
3. Lock the doors by pressing the lock button on the folding key.

After completion of the steps above, the hazard warning lights will blink once to indicate that the system is armed. If any door (and trunk) or engine hood remains open, the hazard warning lights won't operate and theft-alarm will not arm. After this, if all doors (and trunk) and engine hood are closed, the hazard warning lights blink once.

#### \* NOTICE

The theft-alarm system can be deactivated by an authorized Kia dealer. If you want this feature, consult an authorized Kia dealer.

#### \* NOTICE

Do not arm the system until all passengers have left the vehicle. If the system is armed while a passenger(s) remains in the vehicle, the alarm may be activated when the remaining passenger(s) leaves the vehicle. If any door (or trunk) or hood is opened within 30 seconds after the system enters the armed stage, the system will be disarmed to prevent unnecessary alarm.

## Theft-alarm stage

The alarm will be activated if any of the following occurs while the system is armed.

- A front or rear door is opened without using the smart key.
- The trunk is opened without using the smart key.
- The hood is opened.

The horn will sound and the hazard warning lights will blink continuously for approximately 27 seconds, and repeat the horn 3 times unless the system is disarmed. To turn off the system, unlock the doors with the smart key.

## Disarmed stage

The system will be disarmed when:

### Smart key

- The door unlock button is pressed.
- The button of the front outside door is pressed while carrying the smart key.
- The engine is started. (within 3 seconds)

After pressing the unlock button, the hazard warning lights will blink and the chime will sound twice (in smart key) to indicate that the system is disarmed.

After pressing the unlock button, if any door (or trunk) is not opened within 30 seconds, the system will be rearmed.

### Folding key

- The door unlock button is pressed.
- The engine is started. (within 3 seconds)
- The ignition switch is in the "ON" position for 30 seconds or more.

## \* NOTICE

- Avoid trying to start the engine while the alarm is activated. The vehicle starting motor is disabled during the theft-alarm stage.

If the vehicle is not disarmed with the smart key, open the doors by using the mechanical key and start the engine by directly pressing the ENGINE START/STOP button with the smart key to the ON position and wait for 30 seconds. Then the system be disarmed.

- If you lose your keys, consult your authorized Kia dealer.

## ⚠ CAUTION

### Adjusting alarm system

Do not change, alter or adjust the theft alarm system in your vehicle. Improper installation of the alarm system could damage the vehicle or cause the system to malfunction.

## \* NOTICE

Malfunctions caused by improper alterations, adjustments or modifications to the theft-alarm system are not covered by your vehicle manufacturer warranty.



## Door locks

Know how to use the door lock so that you can lock or unlock the door if necessary.

### With the smart key



ODL3A040002

Carrying the smart key, you may lock and unlock the vehicle doors (and trunk). Also, you may start the engine. Refer to the following for more details.

### Locking

Pressing the button of the front driver side door will lock all doors and any unlocked doors. If all doors and engine hood are closed, the hazard warning lights will blink once to indicate that all doors are locked.

The button will only operate when the smart key is within 28~40 inches (0.7~1 m) from the driver side door handle. If you want to make sure that a door has locked or not, you should pull the driver side door handle.

Even though you press the driver side door handle buttons, the doors will not lock and the chime will sound for 3 seconds if any of following occur:

- The smart key is in the vehicle.
- The ENGINE START/STOP button is in the ACC or ON position.

- Any door except the trunk is open.

### Unlocking

Pressing the button of the front driver side door handle with all doors closed and locked, unlocks all the doors. The hazard warning lights blink twice to indicate that all doors are unlocked.

The button will only operate when the smart key is within 28~40 inches (0.7~1 m) from the front driver side door handle.

When the smart key is recognized in the area of 28~40 inches (0.7~1 m) from the front driver side door handle, other people can also open the door without possession of the smart key.

After pressing the button, the doors will lock automatically unless you open any door within 30 seconds.

### With the mechanical key



ODL3A040011

If you lock the driver's door with a mechanical key, the driver's door will lock. If you unlock the driver's door with a mechanical key, you can open and close the driver's door only.

1. Pull out the door handle.
2. Press the lever (1) located inside the bottom part of the cover with a key or flat-head screwdriver.
3. Turn the handle.

3. Push out the cover (2) while pressing the lever.
4. Turn the key (3) toward the rear of the vehicle to unlock and toward the front of the vehicle to lock.
  - Driver's door can also be locked and unlocked with the transmitter.
  - Once the driver's door is unlocked, it may be opened by pulling the door handle.
  - When closing the driver's door, push the door by hand. Make sure the driver's door is closed securely.

#### \* NOTICE

- Be careful when locking the door by mechanical key operation, only the driver's door can be locked/unlocked.
- When all doors are locked with the mechanical key, lock all doors by using the central door lock button inside the vehicle. Open the door using the driver's inner door handle, and then close the door and lock the driver's door with mechanical key operation.
- Refer to "With central door lock button" on page 4-19 to lock from inside the vehicle.

#### \* NOTICE

- When removing the cover, be careful not to lose cover and any scratches.
- When the key cover freezes and does not open, lightly tap or indirectly warm (hand temperature, etc.) it.
- Do not apply excessive force to the door and door handle. It may be damaged.

#### \* NOTICE

- In cold and wet climates, door lock and door mechanisms may not work properly due to freezing conditions.
- If the door is locked/unlocked multiple times in rapid succession with either the vehicle key or door lock switch, the system may stop operating temporarily in order to protect the circuit and prevent damage to system components.

#### ⚠ WARNING

- Securely close your door before you begin driving. Failure to fully close your door may cause it to be opened during vehicle operation.
- Keep your body out of the way of the closing door to prevent injuries.

#### ⚠ WARNING

If any passengers must remain in the vehicle while it is very hot or cold outside, there is risk of injuries or danger to life. Do not lock the vehicle from the outside when there are passengers in the vehicle.

#### ⚠ CAUTION

Do not unnecessarily open and close the door repeatedly or with excessive force. Such action can damage the vehicle door.

#### \* NOTICE

Always place the ENGINE START/STOP button in the OFF position, engage the parking brake, close all windows, and lock all doors when leaving your vehicle unattended.

- If you lock the door with the central door lock button, all vehicle doors will lock automatically.

### \* NOTICE

Always turn off the vehicle, engage the parking brake, close all windows, and lock all doors when leaving your vehicle unattended.

## Operating door locks from inside the vehicle

You can operate door locks with the central door lock button.

### With the door handle



- Front door  
If the inner door handle is pulled when the door is locked, the door will unlock and open.
- Rear door  
If the inner door handle is pulled once when the door is locked, the door will unlock.  
If the inner door handle is pulled once more, the door will open.

## Door lock malfunction

If a power door lock ever fails to function while you are in the vehicle, try one or more of the following techniques to exit:

- Operate the door unlock feature repeatedly (both electronic and manual) while simultaneously pulling on the door handle.
- Lower a front window and use the key to unlock the door from outside.
- Move to the cargo area and open the trunk.

### ⚠ WARNING

Do not pull the inner door handle of driver's (or passenger's) door while the vehicle is moving. Doing so can distract the driver or cause an occupant ejection.

## With central door lock button

Driver side



ODL3H049012

Passenger side



ODL3049015

1. Door Lock
2. Door Unlock
3. Doors indicating light

Operate by pressing the central door lock button.

- To lock all vehicle doors, press the central door lock button (1) of driver and passenger side.
- To unlock all vehicle doors, press central door unlock button (2) of driver and passenger side.

When all vehicle doors are locked, the indicating lights (3) on the driver's door and passenger's door will turn on. If any door is unlocked, it would go off.

Any door is opened, the doors will not lock even though the central door lock button is pressed.

### ⚠ WARNING

#### Doors

- The doors should always be fully closed and locked while the vehicle is in motion to prevent accidental opening of the door. Locked doors will also discourage potential intruders when the vehicle stops or slows down.
- Be careful when opening doors and watch out for vehicles, motorcycles, bicycles or pedestrians approaching the vehicle in the path of the door. Opening a door when something is approaching can result in an accident and cause vehicle damage or serious injury.

### \* NOTICE

#### Unlocked vehicles

Leaving your vehicle unlocked can increase the risk of vehicle theft or any possible criminal harm caused by someone hiding in your vehicle while you are gone. Always turn off the vehicle, engage the parking brake, close all windows and lock all doors when leaving your vehicle unattended.

### ⚠ WARNING

#### Unattended children, the elderly or pets

An enclosed vehicle can become extremely hot, causing death or severe injury such as heatstroke to unattended children, the elderly or pets who cannot escape the vehicle. When left or trapped in a hot vehicle, make sure to stay hydrated and avoid sun exposure

through the vehicle's windshield. Furthermore, children might operate features of the vehicle that could injure them, or they could encounter other harm, possibly from someone gaining entry to the vehicle. Never leave children or animals unattended in your vehicle.

### Door lock/unlock features

The vehicle is equipped with door lock/unlock features for the safety and convenience of passengers.

### Impact sensing door unlock system

All doors will automatically unlock when an impact causes the air bags to deploy.

### Auto door lock/unlock feature

- All doors will automatically lock when the Automatic Transmission/Dual Clutch Transmission shift lever is shifted out of P (Park) (with engine ON, it is activated).
- All doors will automatically unlock when the Automatic Transmission/Dual Clutch Transmission shift lever is shifted into P (Park) (with engine ON, it is activated).

You can activate or deactivate the auto door lock/unlock feature in the vehicle. Refer to "User Settings mode" on page 4-72.

### Child-protector rear door lock (if equipped)

The child safety lock is provided to help prevent children from accidentally opening the rear doors from inside the vehicle.



The rear door safety locks should be used whenever children are in the vehicle.

The child safety lock is located on the edge of each rear door. When the child safety lock is in the lock position (1), the rear door will not open if the inner door handle is pulled.

To lock the child safety lock, insert a key (or screwdriver) into the hole and turn it to the lock position.

To allow a rear door to be opened from inside the vehicle, unlock the child safety lock.

To open the rear door, pull the outside door handle (2).

### **⚠ WARNING**

#### Rear door locks

If children accidentally open the rear doors while the vehicle is in motion, they could fall out and be severely injured or killed. To prevent children from opening the rear doors from the inside, the rear

door safety locks should be used whenever children are in the vehicle.

### Electronic child safety lock system (if equipped)

If you push the electronic child safety lock switch and the indicator appears, rear passengers cannot open the rear door from inside the vehicle.



To cancel the electronic child safety lock system, push the electronic child safety lock system switch one more time and then the indicator turns off.

Safe Exit Assist is operated when the electronic child safety lock system is activated and Safe Exit Assist is selected in the cluster. However, Safe Exit Assist does not automatically activate the electronic child safety lock system.

The electronic child safety lock system is always on when the ENGINE START/STOP button is in the ON and for approximately 10 minutes after the engine is turned off.

If your vehicle is equipped with the Electronic child safety lock system, the Child-protector rear door locks, which are manually operated, are not provided.

If electronic child safety lock system is activated, rear passenger cannot open

or close the rear window also. For more details, refer to "Windows" on page 4-32.

### ⚠ CAUTION

- If the Electronic child safety lock system is not operating while pushing the Electronic child safety lock switch, the message is displayed and the alarm will sound.



If this occurs, have the system inspected by an authorized Kia dealer.

### In case of an emergency

If the electrical power door lock switch is not operating (e.g., dead car battery) the only way to lock the door(s) is with the mechanical key from the outside key hole.

Doors without an outside key hole can be locked as follows:

1. Open the door.
2. Insert the key into the emergency door lock hole and turn the key to the lock position as shown.



3. Close the door securely.

### \* NOTICE

If the electrical power to the door lock switch is not operating (e.g., dead car battery) and the trunk is closed, you will not be able to open the trunk until power is restored.

### Rear Occupant Alert (ROA) system

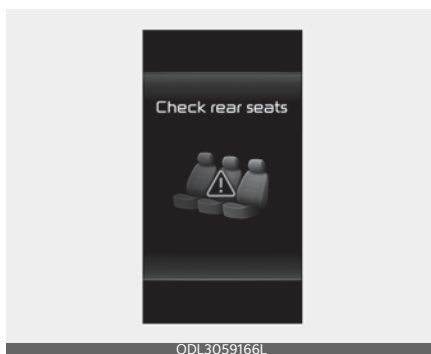

Rear Occupant Alert (ROA) system is provided to help prevent exiting the vehicle with a rear passenger left in the vehicle.

- When you open the front door after opening and closing the rear door and turning off the engine, the "Check rear seats" warning message appears on the cluster.



You can activate or deactivate the ROA from the User Settings mode in the cluster LCD display.

The option can be found under the following menu:

1. Press the MODE button  several times on the steering wheel until 'User Settings' menu appears on the LCD.
2. Select 'Convenience → Rear Occupant Alert' with the MOVE switch  and the OK button on the steering wheel.

If your vehicle is equipped with the infotainment system, the option can be found under the following menu:

1. Press the SETUP button of the infotainment system.

2. Press 'Vehicle → Convenience → Rear Occupant Alert' on the infotainment system screen.

### \* INFORMATION

The infotainment system may change after software updates. For more information, refer to the user's manual provided in the infotainment system and the quick reference guide.

### \* NOTICE

The Rear Occupant Alert (ROA) system does not actually detect objects or people in the rear seat. By using a rear door opened and closed history, the system informs the driver that there may be something in the rear seat.

### \* NOTICE

The Rear Occupant Alert (ROA) system uses a rear door opened and closed history.

The history is reset after the driver turns off ignition normally, gets out of the vehicle and locks the door remotely using the remote keyless entry. So even if a rear door does not reopen, the ROA system alert can occur.

For example, after the ROA alert occurs, if the driver do not lock the door then ride and drive again, the alert can occur.

### ⚠ WARNING

The door lock system may not work if the electrical system is compromised. Accordingly, please train children passengers regarding how to open the car door manually before an emergency situation arises. That way, they would be able to open the door manually in the event an emergency situation arises.



## Driver position memory system (if equipped)

The driver position memory system is provided to store and recall the following memory settings with a simple button operation.



- Driver's seat position
- Outside rearview mirror position
- Head-Up Display (HUD) position and brightness (if equipped)

### **⚠ WARNING**

Never attempt to operate the driver position memory system while the vehicle is moving.

This could result in loss of control, and an accident causing death, serious injury, or property damage.

### **\* NOTICE**

- If the battery is disconnected, the memory settings will be erased.
- If the driver position memory system does not operate normally, have the vehicle checked by an authorized Kia dealer.

## Storing memory positions

1. The ENGINE START/STOP button is in the ON position.
2. Adjust the driver's seat position, outside rearview mirror position and head-up display position/brightness to the desired position.
3. Press the SET button. The system will beep once and notify you "Press button to save settings" on the LCD display.
4. Press one of the memory buttons (1 or 2) within 4 seconds. The system will beep twice when the memory has been successfully stored.
5. "Settings 1 (or 2) saved" will appear on the LCD display.

## Recalling memory positions

1. The ENGINE START/STOP button is in the ON position.
2. Press the desired memory button (1 or 2). The system will beep once, and then the driver's seat position, outside rearview mirror position and head-up display height/brightness will automatically adjust to the stored positions.
3. "Settings 1 (or 2) applied" will appear on the LCD display.
  - While recalling the "1" memory position, pressing the SET or 1 button temporarily stops the adjustment of the recalled memory position. Pressing the 2 button recalls the "2" memory position.
  - While recalling the "2" memory position, pressing the SET or 2 button temporarily stops the adjustment of the recalled memory position. Pressing the 1 button recalls the "1" memory position.

- While recalling the stored positions, pressing one of the control buttons for the driver's seat, outside rearview mirror will cause the movement of that component to stop and move in the direction that the control button is pressed.

### Driver position memory system reset

If the driver position memory system does not work properly, initialize the system as follows.

How to initialize:

1. Stop the vehicle and open the driver's door with the ENGINE START/STOP button in the ON position and the vehicle shifted to P (Park).
2. Pull the driver's seat forward as far as possible and have the seatback upright as much as possible using the driver's seat forward/backward adjustment and seatback angle (recline) switches.
3. Push the SET button and seat forward movement switch for 2 seconds simultaneously.

Initialization in the process:

1. Initialization begins as the alarm sounds.
2. The seat and seatback will automatically move backwards. The alarm sound will continue while the system is in operation.
3. Initialization will be complete after the seat and seatback move to the center with an alarm sound. If, however, cases as follows occur, the initialization process will come to a stop and the alarm sound will stop as well.
  - When pushing driving position memory system button

- When pushing driver's seat height adjustment switch
- When shifting from P (Park) to other positions
- When driving speed exceeds 2 mph (3.2 km/h)
- When the driver's door is closed

### Easy access function (if equipped)

The system will move the driver's seat automatically as follows:

With smart key system

- It will move the driver's seat rearward when the ENGINE START/STOP button is in the OFF position and the driver's door is opened.
- It will move the driver's seat forward when the vehicle is turned ON or the driver's door is closed with the smart key with you.

You can activate or deactivate the Easy Access Function from the User Settings Mode on the LCD display. For more details, refer to "LCD display" on page 4-68. If your vehicle is equipped with an infotainment system, you can learn how to setup on the website via QR code in the infotainment quick reference guide.

#### \* NOTICE

Upward/downward movement of the seat may not work when passengers get in/out of the vehicle in order to prevent foot injuries in certain places.

#### \* INFORMATION

The infotainment system may change after software updates. For more information, refer to the user's manual provided in the infotainment system and the quick reference guide.

## Trunk

### Opening the trunk

1. Make sure the vehicle is in P (Park) and set the parking brake.

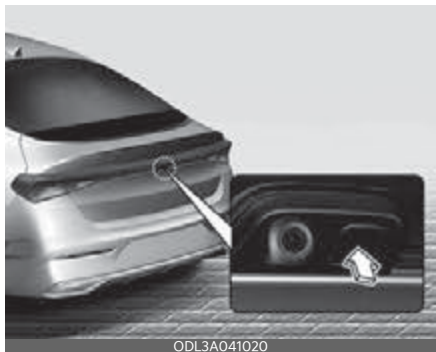

2. Hold down the trunk unlock button located on your remote key or smart key for more than 1 second.

Additionally, for vehicles equipped with smart key:

- While all doors are unlocked, press the unlock button to open trunk with or without the smart key in your possession.
- If any door is locked or all doors are locked, the switch can still be used to open the trunk, as long as the smart key is in your possession.

#### \* NOTICE

The trunk switch is made of plastic. Do not press it using a sharp object such as a key, screwdriver, or drill.

- Use the trunk release button.



3. Lift the trunk lid up.

#### \* NOTICE

In cold and wet climates, door lock and door mechanisms may not work properly due to freezing conditions.

#### ⚠ WARNING

The trunk swings upward. Make sure no objects or people are near the rear of the vehicle when opening the trunk.

#### ⚠ CAUTION

Make certain that you close the trunk before driving your vehicle. Possible damage may occur to the trunk torsion bars and attached hardware if the trunk is not closed prior to driving.

## Closing the trunk

Lower the trunk lid and press down until it locks. To be sure the trunk lid is securely fastened, always check by trying to pull it up again.

### **⚠ WARNING**

#### Exhaust Fumes

The trunk should always be kept completely closed while the vehicle is in motion. If it is left open or ajar, poisonous exhaust gases may enter the car and serious illness or death may result.

### **⚠ WARNING**

Make sure your hands, feet and other parts of your body are safely out of the way before closing the trunk.

## Emergency trunk safety release

### Inside the trunk

Your vehicle is equipped with an Emergency Trunk Safety Release lever located inside the trunk. When someone is inadvertently locked in the trunk, the trunk can be opened by moving the lever in the direction of the arrow and pushing the trunk open.



ODL3A041022

### **⚠ WARNING**

- You and your passengers must be aware of the location of the Emergency Trunk Safety Release lever in this vehicle and how to open the trunk in case you are accidentally locked in the trunk.
- NEVER allow anyone to occupy the trunk of the vehicle at any time. If the trunk is partially or totally latched and the person is unable to get out, serious injury or death could occur due to lack of ventilation, exhaust fumes and rapid heat build-up, or because of exposure to cold weather conditions. The trunk is also a highly dangerous location in the event of a crash because it is not a protected occupant space but is a part of the vehicle's crush zone.
- Your vehicle should be kept locked and the Smart Key should be kept out of the reach of children. Parents should teach their children about the dangers of playing in trunks.
- Use the release lever for emergencies only.

### **⚠ WARNING**

- No one should be allowed to occupy the cargo area of the vehicle at any time. The cargo area is a very dangerous location in the event of a crash.
- Use the release lever for emergencies only. Use with extreme caution, especially while the vehicle is in motion.

### **\* NOTICE**

Make sure there are no people or objects around the trunk before opening or closing the trunk. Wait until the trunk

is open fully and stopped before loading or unloading cargo from the vehicle.

### Inside the vehicle

When you cannot unlock the trunk due to battery discharge or other reasons, you can unlock the trunk inside the vehicle.



Open the cable cover(1) under the rear seat with a mechanical key and pull the cable (2) for unlocking the trunk. The cable is fixed firmly so it may hard to pull. Therefore, please use auxiliary equipment such as a screwdriver to grab the loop and pull it comfortably.

### Smart Trunk (if equipped)

On a vehicle equipped with a smart key, the trunk can be opened using the Smart Trunk system.



### How to use the Smart Trunk

The trunk can be opened with no-touch activation satisfying all the conditions below.

- After 15 seconds when all doors are closed and locked
- Positioned in the detecting area for more than 3 seconds.

#### \* NOTICE

The Smart Trunk does not operate when:

- The smart key is detected within 15 seconds after the doors are closed and locked, and is continuously detected.
- The smart key is detected within 15 seconds after the doors are closed and locked, and 60 inches (1.5 m) from the front door handles. (for vehicles equipped with Welcome Light)
- A door is not locked or closed.
- The smart key is in the vehicle.

## 1. Setting

To activate the Smart Trunk, go to User Settings Mode and select Smart Trunk on the LCD display.

For more details, refer to "LCD display" on page 4-68.

## 2. Detect and Alert



If you are positioned in the detecting area (20~39 inches (50~100 cm)) behind the vehicle carrying a smart key, the hazard warning lights will blink and chime will sound to alert you the smart key has been detected and the trunk will open.

### \* NOTICE

Do not approach the detecting area if you do not want the trunk to open. If you have unintentionally entered the detecting area and the hazard warning lights and chime starts to operate, leave the detecting area with the smart key. The trunk will stay closed.

## 3. Automatic opening



The hazard warning lights will blink and chime will sound 6 times and then the trunk will open.

### ⚠ WARNING

- Make sure you close the trunk before driving your vehicle.
- Make sure there are no people or objects around the trunk before opening or closing the trunk.
- Make sure to deactivate the Smart Trunk when washing your vehicle. Otherwise, the trunk may open inadvertently.

### ⚠ CAUTION

#### Trunk lift

Make certain that you close the trunk before driving your vehicle. Possible damage may occur to the trunk torsion bars and attached hardware if the trunk is not closed prior to driving.

### ⚠ WARNING

Make sure objects in the rear cargo area do not come out when opening the trunk as this could cause serious injury.

### \* NOTICE

The key should be kept out of reach of children. Children may inadvertently open the Smart Trunk while playing around the rear area of the vehicle.

### How to deactivate the Smart Trunk function using the smart key



ODL3A041656

1. Door lock
2. Door unlock
3. Trunk open
4. Panic button
5. Remote start

If you press any button of the smart key during the Detect and Alert stage, the Smart Trunk function will be deactivated.

Make sure to be aware of how to deactivate the Smart Trunk function for emergency situations.

### \* NOTICE

- If you press the door unlock button (2), the Smart Trunk function will be deactivated temporarily. But, if you do not open any door for 30 seconds, the Smart Trunk function will be activated again.

- If you press the trunk open button (3) for more than 1 second, the trunk opens.
- If you press the door lock button (1) or trunk open button (3) when the Smart Trunk function is not in the Detect and Alert stage, the Smart Trunk function will not be deactivated.
- In case you have deactivated the Smart Trunk function by pressing the smart key button and opening a door, the Smart Trunk function can be activated again by closing and locking all doors.

### Detecting area



ODL3A042027

- The Smart Trunk operates with a welcome alert if the smart key is detected within 20~39 inches (50~100 cm) from the trunk.  
The alert stops at once if the smart key is positioned outside the detecting area during the Detect and Alert stage.

**\* NOTICE**

- The Smart Trunk function will not work if any of the following occurs:
    - The smart key is close to a radio transmitter such as a radio station or an airport which can interfere with normal operation of the transmitter.  
The smart key is near a mobile two way radio system or a cellular phone.  
Another vehicle's smart key is being operated close to your vehicle.
  - The detecting range may decrease or increase when:
    - One side of the tire is raised to replace a tire or to inspect the vehicle.  
The vehicle is slantingly parked on a slope or unpaved road, etc.
-



## Windows

The doors of this vehicle are equipped with power windows that can be operated by a switch.

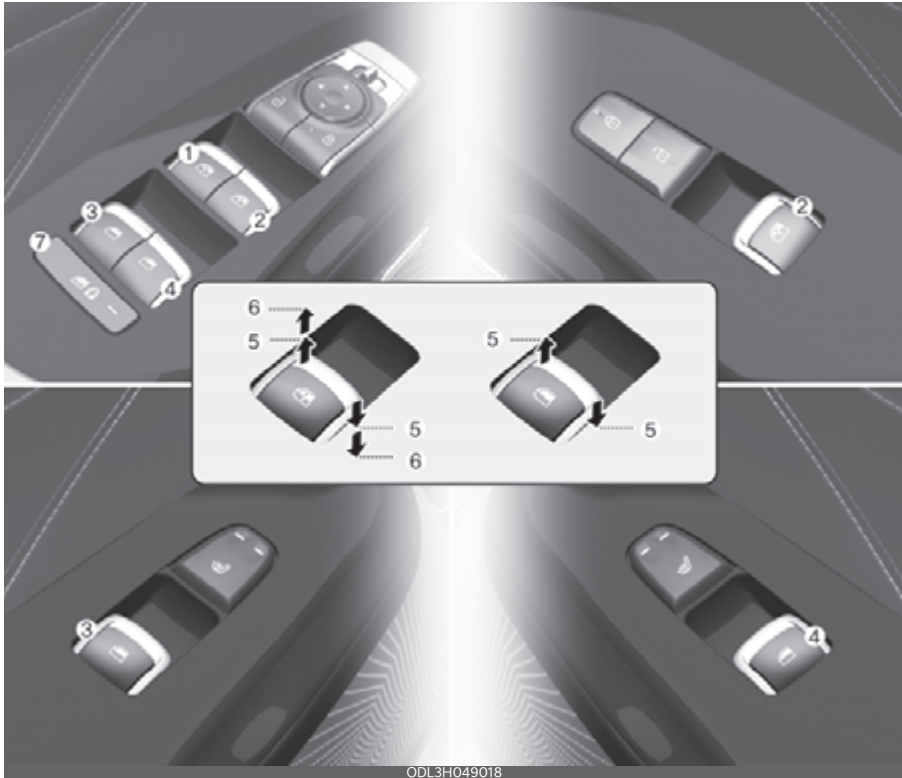

1. Driver's door power window switch
  2. Front passenger's door power window switch
  3. Rear door (left) power window switch
  4. Rear door (right) power window switch
  5. Window opening and closing
  6. Automatic power window up\*/down\*
  7. Power window lock switch
- \*: if equipped

**\* NOTICE**

In cold and wet climates, power windows may not work properly due to freezing conditions.

The ENGINE START/STOP button must be in the ON position for power windows to operate.

Each door has a power window switch that controls the door's window. The driver has a power window lock button which can block the operation of rear passenger windows. The power windows can be operated for approximately 10 minutes after ENGINE START/STOP button turned to the ACC position. However, if the front doors are opened, the power windows cannot be operated even within the 10 minutes period.

The driver's door has a master power window switch that controls all the windows in the vehicle.

If the window cannot be closed because it is blocked by objects, remove the objects and close the window.

**\* NOTICE**

While driving with the rear windows down or with the sunroof (if equipped) in an open (or partially open) position, your vehicle may demonstrate a wind buffeting or pulsation noise. This noise is a normal occurrence and can be reduced or eliminated by taking the following actions. If the noise occurs with one or both of the rear windows down, partially lower both front windows approximately 1 inch (2.5 cm). If you experience the noise with the sunroof open, slightly reduce the size of the sunroof opening.

**⚠ CAUTION**

Do not install any accessories in the vehicle that extend into the open window area. Such objects will impact the proper function of the Automatic reversal "jam protection" feature.

**\* NOTICE**

If you press the one-touch window button for micro adjustment, the glass will go down to a specific location to improve your convenience.

**Window opening and closing**

You can open and close windows using the power window switch.

**Type A**

To open or close a window, press down or pull up the front portion of the corresponding switch to the first detent position (5).

## Type B - Auto up/down window (if equipped)



Pressing or pulling up the power window switch momentarily to the second detent position (6) completely lowers or raises the window even when the switch is released. To stop the window at the desired position while the window is in operation, pull up or press down and release the switch.

### To reset the power windows

If the power window does not operate normally, the automatic power window system must be reset as follows:

1. Turn the ENGINE START/STOP button to the ON position.
2. Close the window and continue pulling up the power window switch for at least 1 second after the window is completely closed.

## Automatic reversal (if equipped)

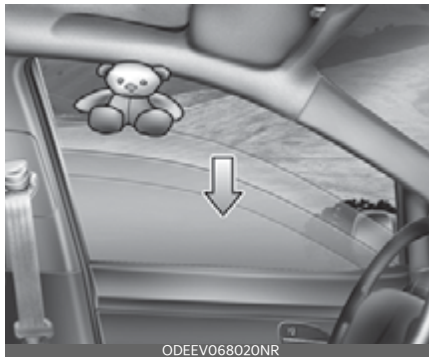

If the upward movement of the window is blocked by an object or part of the body, the window will detect the resistance and will stop upward movement. The window will then lower approximately 11.8 inches (30 cm) to allow the object to be cleared.

If the window detects the resistance while the power window switch is pulled up continuously, the window will stop upward movement then lower approximately 1 inch (2.5 cm).

And if the power window switch is pulled up continuously again within 5 seconds after the window is lowered by the automatic window reversal feature, the automatic window reversal will not operate.

### \* NOTICE

The automatic reverse feature for the window is only active when the "auto up" feature is used by fully pulling up the switch. The automatic reverse feature will not operate if the window is raised using the halfway position on the power window switch.

**⚠ WARNING**

Always check for obstructions before raising any window to avoid injuries or vehicle damage. If an object less than 0.16 of an inch (4 mm) in diameter is caught between the window glass and the upper window channel, the automatic reverse window may not detect the resistance and will not stop and reverse direction.

**⚠ WARNING**

The automatic reverse feature doesn't activate while resetting the power window system. Make sure body parts or other objects are safely out of the way before closing the windows to avoid injuries.

**⚠ CAUTION**

Do not install any accessories in the vehicle that extend into the open window area. Such objects could prevent the automatic reverse feature from functioning.

**Power window lock button**

The driver can disable the power window switches on the rear passengers' doors by pressing the power window lock button to the lock position (pressed).

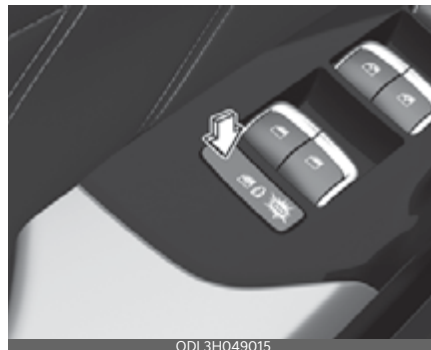

4

When the power window lock button is pressed:

- The driver's master control can operate all passengers' power windows.
- The front passenger's control can operate the front passenger's power window.
- The rear passengers' control cannot operate the rear passenger's power window.

\* If the power window lock switch is operated (indicator turns on), rear passenger cannot open the rear door. (if equipped with the Electronic Child Safety Lock System.) For more details, refer to "Electronic child safety lock system (if equipped)" on page 4-21.

**⚠ CAUTION**

- To prevent possible damage to the power window system, do not open or close two windows or more at the same time. This will also ensure the longevity of the fuse.

- Never try to operate the main switch on the driver's door and the individual door window switch in opposite directions at the same time. If this is done, the window will stop and cannot be opened or closed.

**⚠ WARNING**

**Windows**

- NEVER leave the keys in your vehicle with unsupervised children, when the engine is running.
- NEVER leave any child unattended in the vehicle. Even very young children may inadvertently cause the vehicle to move, entangle themselves in the windows, or otherwise injure themselves or others.
- Always double check to make sure all arms, hands, head and other obstructions are safely out of the way before closing a window.
- Do not allow children to play with the power windows. Keep the driver's door power window lock button in the LOCK position (pressed). SERIOUS INJURY can result from unintentional window operation by the child.
- Do not extend heads or any limbs outside the window while the vehicle is in motion.

**Hood**

The hood serves as a cover for the engine compartment.

Open the hood if maintenance work needs to be performed in the engine compartment or if you need to look at the compartment.

**Opening the hood**

1. Pull the release lever to unlatch the hood. The hood should pop open slightly.



2. Go to the front of the vehicle, raise the hood slightly, push the secondary hood release lever (1) to the left and lift the hood (2).



3. Raise the hood. It will completely rise by itself after it has been raised about halfway.



### Hood open warning

The hood warning message will appear on the LCD display when hood is open.

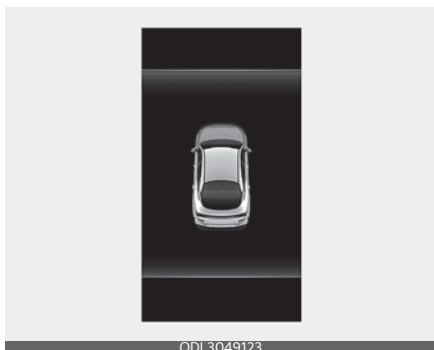

The warning chime will operate when the vehicle is being driven at or above 2 mph (3 km/h) with the hood open.

### Closing the hood

1. Before closing the hood, check the following:
  - All filler caps in the engine compartment must be correctly installed.
  - Gloves, rags or any other combustible material must be removed from the engine compartment.



2. To close the hood, lower the hood and let it drop. Make sure that it locks into place.
3. Check that the hood has engaged properly.
  - If the hood can be raise slightly, it is not properly engaged.
  - Open it again and close it with a little more force.

### ⚠ CAUTION

#### Hood obstruction

Before closing the hood, ensure that all obstructions are removed from the hood opening. Closing the hood with an obstruction present in the hood opening may result in severe personal injury or properly damage.

### ⚠ WARNING

#### Fire risk

Do not leave gloves, rags or any other combustible material in the motor compartment. Doing so may cause a heat-induced fire.

## **⚠ WARNING**

### **Unsecured hood**

Always double check to be sure that the hood is firmly latched before driving away. If it is not latched, the hood could fly open while the vehicle is being driven, causing a total loss of visibility, which may result in an accident.

## **Fuel filler door**

The vehicle's fuel filler door must be opened and closed by hand from outside the vehicle.

### **Opening the fuel filler door**

1. Turn the engine off.
2. Ensure the driver's door is unlocked.
3. Push the fuel filler door near the 3 o'clock position.



ODL3049032

4. Pull the fuel filler door (1) out to fully open.



ODL3049033

5. To remove the fuel tank cap (2), turn it counterclockwise. You may hear a hissing noise as the pressure inside the tank equalizes.
6. Place the cap on the fuel filler door.

**\* NOTICE****The fuel filler door will unlock when Driver's door is unlocked**

To unlock the fuel filler door, follow one of the following instructions:

- Press the unlock button on your smart key
- Press the central door unlock button on armrest trim of driver's door
- Pull the driver's inside door handle outward

**⚠ CAUTION**

Before refueling, be sure to check what type of fuel is used for your vehicle.

If you put diesel fuel into a gasoline-powered vehicle, it may affect the fuel system and cause serious damage to the vehicle.

**\* NOTICE**

If the fuel filler door does not open because ice has formed around it, tap lightly or push on the door to break the ice and release the door. Do not pry on the door. If necessary, spray around the door with an approved de-icer fluid (do not use radiator anti-freeze) or move the vehicle to a warm place and allow the ice to melt.

**Closing the fuel filler door**

1. To install the fuel tank cap, turn it clockwise until it "Clicks".
2. Close the fuel filler door and push it lightly and make sure that it is securely closed.

**\* NOTICE**

Press the vehicle's fuel door to LOCK position when the fuel filler door is completely closed in order to lock the fuel filler door.

If the fuel filler door is not completely closed, the fuel filler door will not be locked.

**After closing the fuel filler door, you must lock all vehicle doors to lock it completely. To lock the fuel filler door, do one of the following:**

To lock fuel filler door:

- Press the lock button on your smart key
- Press the central door lock button on armrest trim of driver's door
  - \* All doors will automatically lock after the vehicle speed exceeds 9.3 mph (15 km/h) Fuel door is also locked when vehicle speed exceeds 9.3 mph (15 km/h)

**⚠ WARNING****Refueling**

Always remove the fuel cap carefully and slowly. If the cap is venting fuel or if you hear a hissing sound, wait until the condition stops before completely removing the cap.

If pressurized fuel sprays out, it can cover your clothes or skin and subject you to the risk of fire and burns.

**\* NOTICE**

When refueling on unlevel ground, the fuel gauge may not point to the F position. It is not a malfunction. If you move your vehicle to a level ground, the fuel gauge will move to the full position.



**\* NOTICE**

Tighten the cap until it clicks one time, otherwise, the engine warning indicator light will appear.

**⚠ CAUTION**

Keep the door into LOCK position when the vehicle is being washed (i.e. high pressure washer, automatic car washer, etc.)

**⚠ WARNING**

Always tighten your fuel cap before you leave the fuel station. Failure to securely install your fuel cap can lead to fuel spillage in an accident and increase fire risk.

**⚠ WARNING****Fire/explosion risk**

Read and follow all warnings posted at the gas station facility. Failure to follow all warnings will result in severe personal injury, severe burns or death due to fire or explosion.

**⚠ WARNING****Static electricity**

- Before touching the fuel nozzle, you should eliminate potentially dangerous static electricity discharge by touching another metal part of the vehicle, a safe distance away from the fuel filler neck, nozzle, or other gas source.
- Do not get back into a vehicle once you have begun refueling since you can generate static electricity by touching, rubbing or sliding against any item or fabric (polyester, satin, nylon, etc.) capable of producing

static electricity. Static electricity discharge can ignite fuel vapors resulting in rapid burning. If you must reenter the vehicle, you should once again eliminate potentially dangerous static electricity discharge by touching a metal part of the vehicle, away from the fuel filler neck, nozzle or other gasoline source.

**⚠ WARNING****Portable fuel container**

When using an approved portable fuel container, be sure to place the container on the ground prior to refueling. Static electricity discharge from the container can ignite fuel vapors causing a fire. Once refueling has begun, contact with the vehicle should be maintained until the filling is complete. Use only approved portable plastic fuel containers designed to carry and store gasoline.

**⚠ WARNING****Cell phone fires**

Do not use cellular phones while refueling. Electric current and/or electronic interference from cellular phones can potentially ignite fuel vapors causing a fire.

**⚠ WARNING****Refueling & Vehicle fires**

When refueling, always shut the engine off. Sparks produced by electrical components related to the engine can ignite fuel vapors causing a fire. Once refueling is complete, check to make sure the filler cap and filler door are securely closed, before starting the engine.

**⚠ WARNING****Smoking**

DO NOT use matches or a lighter and DO NOT SMOKE or leave a lit cigarette in your vehicle while at a gas station especially during refueling. Automotive fuel is highly flammable and can result in fire when ignited.

Make sure to refuel your vehicle according to "Fuel requirements" on page 1-2. If the fuel filler cap requires replacement, use only a genuine Kia cap or the equivalent specified for your vehicle. An incorrect fuel filler cap can result in a serious malfunction of the fuel system or emission control system.

**⚠ CAUTION****Exterior paint**

Do not spill fuel on the exterior surfaces of the vehicle. Any type of fuel spilled on painted surfaces may damage the paint.

**⚠ WARNING**

- Do not allow anyone that has not discharged static electricity from their body to come close to an open fuel tank.
- Do not inhale vaporized fuel.

**⚠ WARNING****Risk of injury from fuel**

Fuels are poisonous and harmful to your health.

- Fuel contains substances that are harmful if inhaled.
- Do not swallow fuel or let it come into contact with skin, eyes or clothing.
- Do not inhale fuel vapors.
- Keep children away from fuel.

If you or other people come into contact with fuel, observe the following:

- Immediately rinse fuel off your skin with soap and water.
- If fuel comes into contact with your eyes, immediately rinse them thoroughly with clean water. Seek medical attention immediately.
- If you swallow fuel, seek medical attention immediately. Do not induce vomiting.
- Change immediately out of clothing that has come into contact with fuel.

**\* NOTICE****Damage caused by the wrong fuel**

- Fuel that does not conform to the required quality can lead to increased wear as well as damage to the engine and exhaust system. Only use the fuel recommended.
- Vehicles with a gasoline engine: Even small amounts of the wrong fuel could result in damage to the fuel system, the engine and the emission control system.
- Do not use diesel to refuel vehicles with a gasoline engine.

**\* NOTICE**

Do not switch on the ignition if you accidentally refuel with the wrong fuel. Otherwise, fuel can enter the fuel system. Even small amounts of the wrong fuel could result in damage to the fuel system and the engine. Have the system serviced by an authorized Kia dealer.

### \* NOTICE

#### Do not overfill the fuel tank

Do not overfill the fuel tank; otherwise fuel may spill, causing harm to the environment and damaging the vehicle.

## Panoramic sunroof (if equipped)

If your vehicle is equipped with a sunroof, you can slide or tilt your sunroof with the sunroof switch located on the overhead console.



The sunroof can only be operated when the ENGINE START/STOP button is in the ON or START position. The sunroof can be operated for approximately 10 minutes after the ENGINE START/STOP button is in the ACC or OFF position. However, if the front door is open, the sunroof cannot be operated even within the 10 minutes period.

### ⚠ WARNING

- Never adjust the sunroof or sunshade while driving. This could result in loss of control and an accident that may cause injury, or property damage.
- Do not leave the engine running and the key in your vehicle with unsupervised children. Unattended children could operate the sunroof, which could result in serious injury.
- Do not sit on the top of the vehicle. It may cause injury or vehicle damage.

## Power sunshade



Use the power sunshade to block direct sunlight coming through the sunroof glass.

- Push the sunroof switch rearward to the first detent position, the power sunshade automatically slides open.
- Push the sunroof switch forward to the first detent position, the power sunshade will automatically closes. However, if the sunroof glass is open, the glass will close first.

To stop the power sunshade at any point, push the sunroof switch in any direction.

### \* NOTICE

- Do not pull or push the power sunshade by hand as such action may damage the power sunshade or cause it to malfunction.
- Wrinkles formed on the power sunshade are normal due to material characteristic.

## Tilt open/close



- Push the sunroof switch upward, the sunroof glass tilts open. However, if the power sunshade is close, the sunshade will open first.
- Push the sunroof switch upward or forward when the sunroof glass will automatically closes.

To stop the sunroof movement at any point, push the sunroof switch in any direction.

## Slide open/close



- Push the sunroof switch rearward to the first detent position, the sunroof glass opens. However, if the power sunshade is close, the power sunshade will open first.

Push the sunroof switch forward to the first detent position, the sunroof glass closes. However, if the sunroof glass is close, the power sunshade will close.

- Push the sunroof switch forward or rearward to the second detent position, the power sunshade and sunroof glass operate automatically (auto slide feature).

To stop the sunroof movement at any point, push the sunroof switch in any direction.

### Automatic reversal



If the power sunshade or sunroof glass senses any obstacle while it is closing automatically, it will reverse direction then stop at a certain position. The auto reverse function may not work if an object thin or soft is caught between the sliding power sunshade or sunroof glass and sunroof sash.

### ⚠ WARNING

- Make sure heads, hands, arms or any other body parts or objects are out of the way before operating the sunroof. Body parts or objects may get caught causing injuries or vehicle damage.
- Never deliberately use your body parts to test the automatic reversal

function. The power sunshade or sunroof glass may reverse direction, but there is a risk of injury.

### \* NOTICE

- Do not continue to push the sunroof switch after the sunroof is fully opened, closed, or tilted. Damage to the sunroof motor could occur.
- Continuous operations such as slide open/close, tilt open/close, etc. may cause the motor or sunroof system to malfunction.
- Regularly remove any accumulated dust on the sunroof rail.
- Dust accumulated between the sunroof and roof panel can make noise. Open the sunroof and remove dust regularly using a clean cloth.
- Do not try to open the sunroof when the temperature is below freezing or when the sunroof is covered with snow or ice. The sunroof may not work properly and may break if opened by force.
- Do not open or drive with the sunroof glass open immediately after rain or washing the vehicle. Water may wet the interior of the vehicle.
- Do not extend any luggage outside the sunroof while driving. Vehicle damage may occur if the vehicle suddenly stops.

### ⚠ WARNING

Do not extend your head, arms, body parts or objects outside the sunroof while driving. Injuries may occur if the vehicle suddenly stops.

## Resetting the sunroof



In some circumstances resetting the sunroof operation may need to be performed. Some instances where resetting the sunroof may be required include:

- When the 12-volt battery is either disconnected or discharged
- When the sunroof fuse is replaced
- If the sunroof one-touch AUTO OPEN/CLOSE operation is not functioning properly

Sunroof resetting procedure:

1. It is recommended to perform the reset procedure with the vehicle engine running. Start the vehicle in P (Park).
2. Make sure the power sunshade and sunroof glass are in the fully closed position. If the power sunshade and sunroof glass are open, push the switch forward until the power sunshade and sunroof glass are fully closed.
3. Release the switch when the power sunshade and sunroof glass are fully closed.
4. Push the switch forward until the power sunshade and sunroof glass move slightly. Then release the switch.

5. Once again push and hold the sunroof switch forward until the power sunshade and sunroof glass slide open and close. Do not release the switch until operation is completed. If you release the switch during operation, start the procedure again from step 2.

### \* NOTICE

If the sunroof does not reset when the vehicle battery is disconnected or discharged, or the sunroof fuse is blown, the sunroof may not operate normally.

## Sunroof open warning

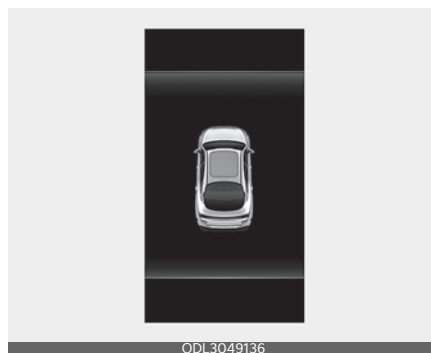

If the driver turns off the engine when the sunroof is not fully closed, the warning chime will sound for several seconds and the sunroof open warning will appear on the cluster LCD display. Close the sunroof securely when leaving your vehicle.

### ⚠ CAUTION

Make sure the sunroof is closed fully when leaving your vehicle. If the sunroof is left open, rain or snow may wet the interior of the vehicle. Also, leaving the sunroof open when the vehicle is unattended may invite theft.

## Steering wheel

The steering wheel of this vehicle is equipped with the Motor Driven Power Steering (MDPS) system.

### Motor Driven Power Steering (MDPS)

Power steering uses the motor to assist you in steering the vehicle.

If the engine is off or if the power steering system becomes inoperative, the vehicle may still be steered, but it will require increased steering effort.

The MDPS is controlled by the power steering control unit which senses the steering wheel torque and vehicle speed to command the motor.

The steering effort becomes heavier as the vehicle's speed increases and becomes lighter as the vehicle's speed decreases for better control of the steering wheel.

Should you notice any change in the effort required to steer during normal vehicle operation, have the power steering checked by an authorized Kia dealer.

#### \* NOTICE

The following symptoms may occur during normal vehicle operation:

- When the ENGINE START/STOP button is the ON position, the steering wheel enters normal operation mode after diagnosing the Motor Driven Power Steering system (for about 3 seconds).
- A click noise may be heard from the MDPS relay after turning the ENGINE START/STOP button is turned to the ON or OFF position.
- If the steering wheel is operated when the vehicle is not in motion or driven

at a low speed, you may hear some noise.

- If the Motor Driven Power Steering system does not operate normally, the warning light will appear or blink on the instrument cluster. If the power assistance of steering fails, you will need to use more force to steer.
- Operating the steering wheel at lower temperatures may require more force and accompany noise. However, when the temperature increases, it returns to normal.
- Take your vehicle to an authorized Kia dealer and have the vehicle checked as soon as possible.
- When the charging system warning light comes on due to the low voltage (when the alternator or battery does not operate normally or malfunctions), the steering wheel may require increased steering effort.

#### \* NOTICE

When you continuously operate the steering wheel, the overcurrent protection device is activated and it requires more force to operate the steering wheel. However, this doesn't indicate a malfunction, and it works for your safety and will return to normal after some time.

#### \* NOTICE

If the Motor Driven Power Steering (MDPS) system does not work or an error occurs, the warning light on the instrument panel may be turned on or blink and it may require more force to operate the steering wheel. In this case, please hold the steering wheel more tightly than usual and operate with

greater force. And then immediately pull your vehicle over to a safe place and have your vehicle inspected by an authorized Kia dealer.

### Tilt & telescopic steering wheel

A tilt and telescopic steering wheel allows you to adjust the steering wheel before you drive. You can also raise it to give your legs more room when you exit and enter the vehicle.

The steering wheel should be positioned so that it is comfortable for you to drive, while permitting you to see the instrument panel warning lights and gauges.

#### **⚠ WARNING**

#### Steering wheel adjustment

Never adjust the angle and height of the steering wheel while driving. You may lose steering control.

### Adjusting steering wheel angle and height



1. To change the steering wheel angle, pull down the lock release lever (1).
2. Adjust the steering wheel to the desired angle (2) and height (3).

Move the steering wheel, so it points toward your chest, not toward your

face. Make sure you can see the instrument panel warning lights and gauges. After adjusting, pull up the lock.

3. Pull up the lock-release lever to lock the steering wheel in place.  
Push the steering wheel both up and down to be certain it is locked in position.
4. Be sure to adjust the steering wheel to the desired position before driving.

#### **\* NOTICE**

After adjustment, sometimes the lock-release lever may not lock the steering wheel.

It is not a malfunction. This occurs when two gears engage. In this case, adjust the steering wheel again and then lock the steering wheel.

### Heated steering wheel (if equipped)

When the ENGINE START/STOP button is in the ON position, pressing the heated steering wheel button warms the steering wheel. The indicator on the button will illuminate.



To turn the heated steering wheel off, press the button once again. The indicator on the button will turn off.



- The heated steering wheel defaults to the OFF position whenever the ENGINE START/STOP button is in the ON position.

### \* NOTICE

The heated steering wheel will turn off automatically approximately 30 minutes after the heated steering wheel is turned on.

### ⚠ CAUTION

- Do not install any type of grip cover for the steering wheel, it may impair the function of the heated steering wheel system.
- When cleaning the heated steering wheel, do not use an organic solvent such as paint thinner, benzene, alcohol and gasoline. Doing so may damage the surface of the steering wheel.
- If the surface of the steering wheel is damaged by a sharp object, damage to the heated steering wheel components could occur.

### ⚠ WARNING

If the steering wheel becomes too warm, turn the system off. The heated steering wheel may cause burns even at low temperatures, especially if used for long periods of time.

## Horn

To sound the horn, press the area indicated by the horn symbol on your steering wheel (see illustration).



ODL3A041040

The horn will operate only when this area is pressed. Check the horn regularly to be sure it operates properly.

### \* NOTICE

To sound the horn, press the area indicated by the horn symbol on your steering wheel (see illustration). The horn will operate only when this area is pressed.

### ⚠ CAUTION

Do not strike the horn severely to operate it, or hit it with your fist. Do not press on the horn with a sharp-pointed object.

## Mirrors

This vehicle is equipped with inside and outside rear view mirrors to provide views of objects behind the vehicle.

### Inside rear view mirror

Adjust the rear view mirror so that the center view through the rear window is seen. Make this adjustment before you start driving.

Do not place objects in the rear seat or cargo area which would interfere with your vision out the rear window.

#### **⚠ WARNING**

##### **Mirror adjustment**

Do not adjust the rear view mirror while the vehicle is moving. This could result in loss of control.

#### **\* NOTICE**

Do not modify the inside mirror in any manner, including installing a wide mirror. Doing so could result in injury during an accident or deployment of the air bag.

#### **⚠ CAUTION**

##### **Cleaning mirror**

When cleaning the mirror, use a paper towel or similar material dampened with glass cleaner. Do not spray glass cleaner directly on the mirror. It may cause the liquid cleaner to enter the mirror housing.

### Day/night rear view mirror (if equipped)



(1): Day, (2): Night

Make this adjustment before you start driving and while the day/night lever is in the day position (1).

Pull the day/night lever toward you (2) to reduce the glare from the headlights of the vehicles behind you during night driving.

Remember that you lose some rear view clarity in the night position.

### Electric Chromic Mirror (ECM) (if equipped)

The electric rear view mirror automatically controls the glare from the headlights of the vehicles behind you in nighttime or low light driving conditions.



The sensor mounted in the mirror senses the light level around the vehicle, and automatically controls the headlight glare from the vehicles behind you.

When the engine is running, the glare is automatically controlled by the sensor mounted in the rear view mirror.

### **⚠ CAUTION**

#### **Cleaning mirror**

When cleaning the mirror, use a paper towel or similar material dampened with glass cleaner. Do not spray glass cleaner directly on the mirror. It may cause the liquid cleaner to enter the mirror housing.

#### **Electrochromic mirror (ECM) with HomeLink® system (if equipped)**



1. HomeLink Channel 1
2. HomeLink Channel 2
3. HomeLink Channel 3
4. Garage Door Opener Status Indicator: Closing or Closed
5. HomeLink Operation Indicator
6. Garage Door Opener Status Indicator: Opening or Opened
7. HomeLink User Interface Indicator

Your vehicle may be equipped with a Gentex Automatic-Dimming Mirror with an Integrated HomeLink® Wireless Control System.

During nighttime driving, this feature will automatically detect and reduce rear-view mirror glare. The HomeLink® Universal Transceiver allows you to activate your garage door(s), electric gate, home lighting, etc.

#### **Automatic-Dimming Night Vision Safety™ (NVS®) Mirror (if equipped)**

The NVS® Mirror automatically reduces glare by monitoring light levels in the front and the rear of the vehicle. Any object that obstructs either light sensor will degrade the automatic dimming control feature.

**For more information regarding NVS® mirrors and other applications, please refer to the Gentex website: [www.gentex.com](http://www.gentex.com)**

Your mirror will automatically dim upon detecting glare from the vehicles traveling behind you.

The mirror defaults to the ON position each time the vehicle is started.

#### **Integrated HomeLink® Wireless Control System**

The HomeLink® Wireless Control System provides a convenient way to replace up to three handheld radio-frequency (RF) transmitters used to activate compatible devices such as gate operators, garage door openers, entry door locks, security systems, and home lighting.

### \* NOTICE

Considering home security when the vehicle is parked outside the garage, HomeLink will **ONLY** work when the ignition switch is in ACC position or ON position.

### ▲ CAUTION

Before programming HomeLink to a garage door opener or gate operator, make sure that people and objects are out of the way to prevent potential harm or damage. When programming a garage door opener, it is advised to park outside of the garage.

Do not use HomeLink with any garage door opener that lacks safety stop and reverse features as required by U.S. federal safety standards (this includes any garage door opener model manufactured before April 1, 1982). A garage door that cannot detect an object signaling the door to stop and reverse - does not meet current U.S. federal safety standards. For more information, contact HomeLink at **www.homelink.com**, or call HomeLink customer support at **1-800-355-3515**.

It is also recommended that a new battery be replaced in the hand-held transmitter of the device being trained to HomeLink for quicker training and accurate transmission of the radio frequency.

## 1. Programming HomeLink®

The following steps show how to program HomeLink. If you have any questions or are having difficulty programming your HomeLink buttons, refer to the HomeLink website or call the HomeLink customer support toll-free

number. Do this, before going back to the dealer who sold you the car.

- Visit the HomeLink website at: [www.homelink.com](http://www.homelink.com) and at the top of the page, choose your vehicle make. Then watch the YouTube video, and/or access additional website information.
- If you choose to access the website via your cell phone, scan the QR code.



- Or, call HomeLink customer support at **1-800-355-3515** (Please have the vehicle make/model AND the opener device make/model readily available.)

### 1) Programming Preparation

1. When programming a garage door opener, it is advised to park the vehicle outside of the garage.
2. It is recommended that a new battery be placed in the hand-held transmitter of the device being programmed to HomeLink for quicker training and accurate transmission of the radio-frequency signal.
3. Place the ignition switch to the ACC (Accessory) position for programming of HomeLink.



### 2) Programming a New Home-Link® Button

1. Press and release the HomeLink button (1), (2) or (3), you would like to program. The HomeLink indicator light (7) will flash orange slowly (if not, perform the steps of "Erasing Home-Link Buttons" section, and start over).



2. Position the garage door opener remote 1 - 3 inches (2 - 8 cm) away from the HomeLink buttons.



3. While the HomeLink indicator light (7) is flashing orange, press and hold the hand-held remote button. Continue pressing the hand-held remote button until the HomeLink indicator light (7) light changes from orange to green. You may now release the hand-held remote button.

4. Wait until your garage door comes to a complete stop, regardless of position, before proceeding to the next steps.
5. Press and release the HomeLink button you are programming and observe the indicator light.
  - If the indicator light remains solid green, your device should operate when the HomeLink button is pressed. At this point, if your device operates, programming is complete.
  - If the indicator light rapidly flashes green, firmly press, hold for two seconds and release the HomeLink button up to three times in a row slowly to complete the programming process. Do not press the HomeLink button rapidly. At this point if your device operates, programming is complete. If the device does not operate, continue with step 6.
6. At the garage door opener motor, (security gate motor, etc.) locate the "Learn", "Smart", "Set" or "Program" button. This can usually be found where the hanging antenna wire is attached to the motor-head unit (see the device's manual to identify this button). The name and color of the button may vary by manufacturer.

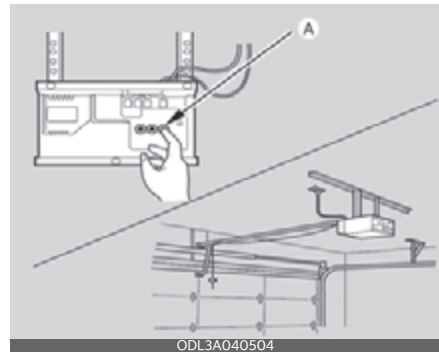

\* A ladder and/or second person may simplify the following steps.

7. Firmly press and release the "Learn", "Smart", "Set" or "Program" button. You now have up to 30 seconds in which to complete the next step.
8. Return to the vehicle and firmly press, hold for two seconds and release, the HomeLink button up to three times in a row slowly. Do not press the HomeLink button rapidly. As soon as you see the garage door start to move, stop pressing any buttons until a few seconds after the garage door has come to a complete stop, regardless of position. At this point programming is complete and your device should operate when the HomeLink button is pressed and released.

### 3) Two-Way Communication Programming (For select garage door openers)

If your garage door opener has the 'myQ' logo on its side, your opener likely has Two-Way Communication capability. HomeLink has the capability to establish Two-Way Communication with your garage door opener. HomeLink can receive and display "closing" or "opening" status messages from compatible garage door openers. At any time, HomeLink can also recall and display the last recorded status communicated by the garage door opener to indicate your garage door being "closed" or "opened".

To check if your garage door opener is compatible with this feature, refer to [www.homelink.com/compatible/Two-way-Communication](http://www.homelink.com/compatible/Two-way-Communication). If your garage door opener has this functionality, AND the Two-Way Communication indicators (4), (6) in the mirror appear while the garage door is opening/closing, then no further steps are needed. Two-Way Communication Programming is already complete. However, if your garage door opener has this functionality, AND the Two-Way Communication indicators (4), (6) in the mirror DO NOT appear while the garage door is opening/closing, use the following instructions to enable this functionality.

1. In your vehicle, press and hold the programmed HomeLink button for 2 seconds, then release. Confirm that the garage door is moving. AFTER it stops, you will have one minute to complete the following steps:

\* A ladder and/or second person may simplify the following steps.

2. On your garage door opener in your garage, locate the "Learn" button (usually near where the hanging antenna wire is attached to the garage door opener). If there is difficulty locating this button, reference the device's owner's manual.
3. Press and release the "Learn" button.
4. A light on your garage door opener may flash, and your Two-Way Communication indicators (4), (6) in your vehicle may flash, confirming completion of the process.
5. Return to the vehicle and firmly press and release the programmed HomeLink button to activate your garage door. The Two-Way Communication indicators (4), (6) flash in orange when the door is moving. Do not make any additional button presses until AFTER the garage door has come to a complete stop.
6. Your Two-Way Communication programming is now complete.

#### \* NOTICE

If your garage door opener has Two-Way Communication functionality, it is possible for HomeLink to stop operating the garage door shortly after initial programming, IF the Two-Way Communication Programming wasn't properly completed. This usually happens after the first 10 times a programmed HomeLink button is pressed. If you experience this, completing the "Programming a New HomeLink Button" and "Two-Way Communication Programming" will restore door operation.

#### 4) Canadian Programming

Canadian radio-frequency laws require transmitter remote signals to "time-out" (or quit) after a couple seconds of transmission, which may not be long enough for HomeLink to pick up the signal during programming.

If you live in Canada or you are having difficulties programming a gate operator or garage door opener by using the programming procedures, replace "Programming a New HomeLink Button" step 3 with the following:

While the HomeLink indicator light (7) is flashing orange, press and release ("cycle") your device's hand-held remote every two seconds until the HomeLink indicator light (7) changes from orange to green. You may now release the hand-held remote button. Then proceed with "Programming a New HomeLink Button" step 4.

## 2. Operating HomeLink®

### 1) Operating HomeLink®

1. Press and release the desired programmed HomeLink button (1, 2 or 3).



#### \* NOTICE

The HomeLink indicator (7) should light green, solid or flashing, and your programmed device should operate.

If your device does not operate, the HomeLink programming was not successful, and you'll need to reprogram the button.



## 2) Two-Way Communication Display Behavior

1. Press and release one of the programmed HomeLink buttons (1, 2 or 3)



2. The indicator (4) and (6) operates as below, if your garage door opener has Two-Way Communication functionality.



- If the indicator (4) flashes in Orange, it indicates that the garage door is "Closing".
- The indicator (4) turns solid green once the garage door has closed.
- If the indicator (6) flashes in Orange, it indicates that the garage door is "Opening".

- The indicator (6) turns solid green once the garage door has fully opened.
- If the indicator (4) or (6) does not turn to green, it indicates that the last status of garage door was not received properly. The HomeLink mirror tries to receive the last known status of the garage door for a few seconds.

## 3) Recalling Garage Door Status

HomeLink mirror with Two-Way Communication provides a way to view the last stored message from the garage door opener. In order to recall the last known status of the last activated device, press the buttons "1 and 2" OR "2 and 3" simultaneously.

- If the indicator (4) appears solid Green, it indicates that the last activated device was "closed" properly.
- If the indicator (6) appears solid Green, it indicates that the last activated device was "opened" properly.

## 3. Erasing HomeLink® Buttons

### 1) Erasing and Reprogramming a Single HomeLink® Button:

1. Press and hold the desired HomeLink button you want to re-program. DO NOT release the button.
2. The HomeLink indicator light (7) will illuminate solid green. Release the button as soon as the HomeLink indicator light (7) begins to flash orange, usually about 20 seconds.
3. Proceed with the steps in the "Programming a New HomeLink Button" section.

### \* NOTICE

If you do not complete the re-programming of a new device to the button, it will revert to the previously stored programming.

## 2) The following instructions will erase ALL HomeLink® programming from ALL buttons:



1. Press and hold the buttons (1) and (3) simultaneously
2. The HomeLink indicator light (7) will illuminate solid Orange for about 10 seconds
3. Release the buttons once the HomeLink indicator light (7) changes to Green and flashes rapidly
4. Now all three HomeLink buttons (1), (2) and (3) are cleared of any programming

### Information

HomeLink and the HomeLink House logo are registered trademarks of Gen-tex Corporation.

The myQ logo is a registered trademark of The Chamberlain Group, Inc

## FCC (USA) and ISED (Canada)

This device complies with FCC rules part 15 and Innovation, Science, and Economic Development Canada RSS-210. Operation is subject to the following two conditions: (1) This device may not cause harmful interference, and (2) This device must accept any interference that may be received including interference that may cause undesired operation. **WARNING:** The transmitter has been tested and complies with FCC and ISED rules. Changes or modifications not expressly approved by the party responsible for compliance could void the user's authority to operate the device.

This equipment complies with FCC and ISED radiation exposure limits set forth for an uncontrolled environment. End Users must follow the specific operating instructions for satisfying RF exposure compliance. This transmitter must be at least 20 cm from the user and must not be co-located or operating in conjunction with any other antenna or transmitter.

## FCC (États-Unis) et ISED (Canada)

Cet appareil est conforme aux règlements de la FCC, section 15, et au CNR-210 d'Innovation, Sciences et Développement économique Canada. Le fonctionnement est assujéti aux deux conditions suivantes: (1) cet appareil ne doit pas causer d'interférences nuisibles et (2) cet appareil doit accepter toute interférence reçue, y compris celle qui pourrait entraîner un dysfonctionnement. **MISE EN GARDE:** L'émetteur a subi des tests et est conforme aux règlements de la FCC et d'ISDE. Les changements ou modifications non approuvés explicitement par la partie responsable de la conformité pourraient rendre

caduque l'autorisation de l'utilisateur de se servir du dispositif.

Cet appareil est conforme aux limites d'exposition aux radiations de la FCC et d'ISDE établies pour un environnement non contrôlé. Les utilisateurs finaux doivent respecter les instructions d'utilisation spécifiques pour satisfaire aux exigences de conformité aux expositions de RF. L'émetteur doit se trouver à 20 cm au minimum de l'utilisateur et ne doit pas être situé au même endroit que tout autre émetteur ou antenne ni fonctionner avec un autre émetteur ou antenne.

### **México**

La operación de este equipo está sujeta a las siguientes dos condiciones: (1) es posible que este equipo o dispositivo pueda no causar interferencia dañina, y (2) este dispositivo o dispositivos deben aceptar cualquier interferencia, que incluye la interferencia que puede causar su operación no deseada.

# HomeLink 5 Programing Flow Chart

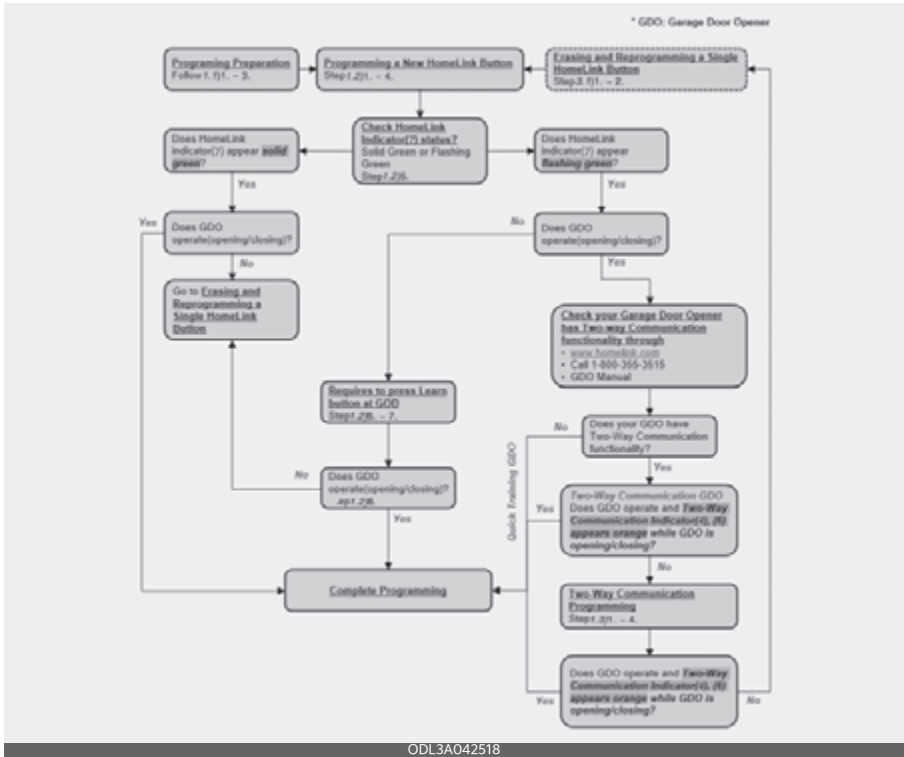

4

## Outside rear view mirror

Your vehicle is equipped with both left-hand and right-hand outside rear view mirrors.

Be sure to adjust the mirror angles before driving.

The mirrors can be adjusted remotely with the control levers or remote switch, depending on the type of mirror control installed. The mirror heads can be folded back to prevent damage during an automatic car wash or when passing through a narrow street.

### \* NOTICE

#### Rear view mirrors

- The right outside rear view mirror is convex. Objects seen in the mirror are closer than they appear.
- Use your interior rear view mirror or direct observation to determine the actual distance of following vehicles when changing lanes.

### ⚠ CAUTION

Do not scrape ice off the mirror face; this may damage the surface of the glass. If ice should restrict the movement of the mirror, do not force the mirror for adjustment. To remove ice, use a deicer spray, or a sponge or soft cloth with warm water.

If the mirror is jammed with ice, do not adjust the mirror by force. Use an approved spray de-icer (not radiator antifreeze) to release the frozen mechanism or move the vehicle to a warm place and allow the ice to melt.

### ⚠ WARNING

Do not adjust or fold the outside rear view mirrors while the vehicle is moving. This could result in loss of control, and an accident which could cause DEATH, SERIOUS INJURY, or property damage.

## Adjusting the outside rear view mirrors

The electric remote control mirror switch allows you to adjust the position of the left and right outside rear view mirrors.

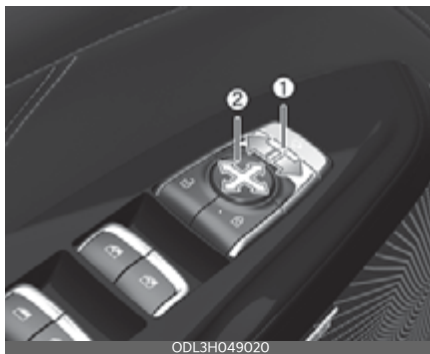

ODL3H049020

Adjusting the rear view mirrors:

1. Move the R or L switch (1) to select the right side mirror or the left side mirror.
2. Press a corresponding point on the mirror adjustment control (2) to position the selected mirror up, down, left or right.

### ⚠ CAUTION

- The mirrors stop moving when they reach the maximum adjusting angles, but the motor continues to operate while the switch is pressed. Do not press the switch longer than necessary, the motor may be damaged.
- Do not attempt to adjust the outside rear view mirror by hand. Doing so may damage the parts.

- When the mirror control, press exactly "▲" (2) marking area. Otherwise, the mirror will move to unintended direction or malfunction.

### Folding the outside rear view mirror

#### Manual type (if equipped)

To fold the outside rear view mirror, grasp the housing of the mirror and then fold it toward the rear of the vehicle.



ODL3049043

#### Electric type (if equipped)

The outside rear view mirror can be folded or unfolded by pressing the switch when the ENGINE START/STOP button is in the ON position as below.



ODL3049045

- To fold the outside rear view mirror depress the button.

- To unfold it, depress the button again.

#### \* NOTICE

The electric type outside rear view mirror operates even though the ENGINE START/STOP button is in the OFF position. However, to prevent unnecessary battery discharge, do not adjust the mirrors longer than necessary while the engine is not running.

#### ⚠ CAUTION

In case it is an electric type outside rear view mirror, don't fold it by hand. It could cause motor failure.

4

### Reverse parking aid function (if equipped)

When you move the shift lever to the R (Reverse) position, the outside rear view mirror(s) will rotate downwards to aid with driving in reverse.

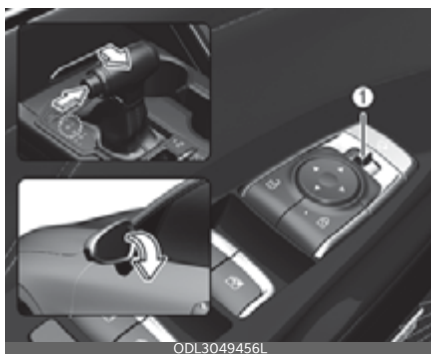

ODL3049456L

The position of the outside rearview mirror switch (1) determines whether or not the mirrors will move:

Left/Right: When either the L (Left) or R (Right) switch is selected, both outside rear view mirrors will move.

Neutral: When neither switch is selected, the outside rear view mirrors will not move.

The outside rear view mirrors will automatically revert to their original positions if any of the following occur:

- The ENGINE START/STOP button is placed to either the OFF position or the ACC position.
- The shift lever is moved to any position except R (Reverse).
- The remote control outside rearview mirror switch is not selected.

## Instrument cluster



\* The actual cluster in the vehicle may differ from the illustration.

1. Tachometer
2. Speedometer
3. Engine coolant temperature gauge
4. Fuel gauge
5. LCD display (including Trip computer)
6. Warning and indicator lights



### Adjusting instrument cluster illumination

The brightness of the instrument panel illumination is changed by pressing the illumination control button ("+" or "-") when the ENGINE START/STOP button is ON, or the tail lights are turned on.



### **⚠ WARNING**

Never adjust the instrument cluster while driving. This could result in loss of control and lead to an accident that may cause DEATH, SERIOUS INJURY, or property damage.

- If you hold the illumination control button ("+" or "-"), the brightness will be changed continuously.



- If the brightness reaches to the maximum or minimum level, an alarm will sound.

### Gauges

The gauges display various information such as the speed of the vehicle, and so on.

### Speedometer

mph, km/h

km/h



The speedometer indicates the speed of the vehicle and is calibrated in miles per hour (mph) and kilometers per hour (km/h).

### Tachometer



The tachometer indicates the approximate number of engine revolutions per minute (rpm).

Use the tachometer to select the correct shift points and to prevent lugging and/or over-revving the engine.

**⚠ CAUTION****Red zone**

Do not operate the engine within the tachometer's RED ZONE. This may cause severe engine damage.

**Engine coolant temperature gauge**

This gauge indicates the temperature of the engine coolant when the ENGINE START/STOP button is ON.

**⚠ CAUTION**

If the gauge pointer moves beyond the normal range area (between the C-H) toward the "H" position, it indicates overheating that may damage the engine. Do not continue driving with an overheated engine. If your vehicle overheats, refer to "If the engine overheats" on page 7-6.

**⚠ WARNING**

Never remove the engine coolant reservoir cap when the engine is hot. The engine coolant is under pressure and could severely burn. Wait until the engine is cool before adding coolant to the reservoir.

**⚠ WARNING****Engine coolant reservoir cap**

Do not remove the engine coolant reservoir cap when the engine is hot. This may result in coolant being blown out of the opening and cause serious burns.

**Fuel gauge**

This gauge indicates the approximate amount of fuel remaining in the fuel tank.

**\* NOTICE**

- The fuel tank capacity is given in "Recommended lubricants and capacities" on page 9-9.
- The fuel gauge is supplemented by a low fuel warning light, which will appear when the fuel tank is nearly empty.
- On inclines or curves, the fuel gauge pointer may fluctuate or the low fuel warning light may come on earlier than usual due to the movement of fuel in the tank.

**⚠ WARNING**

**Fuel Gauge**

Running out of fuel can expose vehicle occupants to danger.

You must stop and obtain additional fuel as soon as possible after the warning light comes on or when the gauge indicator comes close to the "E" level.

**⚠ CAUTION**

Avoid driving with an extremely low fuel level. Running out of fuel could cause the engine to misfire, which could damage the catalytic converter.

**\* NOTICE**

The fuel display may not be accurate if the vehicle is on an incline.

**Odometer**

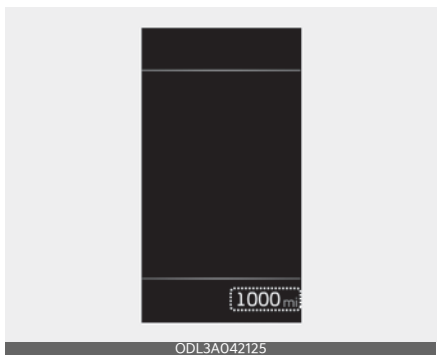

The odometer indicates the total distance that the vehicle has been driven and should be used to determine when periodic maintenance should be performed.

- Odometer range: 999,999 miles or 0~1,599,999 km.

**Distance to empty**



- The distance to empty is the estimated distance the vehicle can be driven with the remaining fuel.
  - Distance range: 1~9,999 miles or 1~9,999 km.
- If the estimated distance is below 1 mile (1 km), the trip computer will display "---" as distance to empty.
- If the level of the remaining fuel is more than three-quarters, more than 0.8 gallons (3 liters) of fuel must be refilled for the fuel gauge to change. In other cases, more than 1.6 gallons (6 liters) of fuel must be refilled for the vehicle to change the fuel gauge.

**\* NOTICE**

- If the vehicle is not on level ground or the battery power has been interrupted, the distance to empty function may not operate correctly.
- The distance to empty may differ from the actual driving distance as it is an estimate of the available driving distance.
- The trip computer may not register additional fuel if less than 1.6 gallons (6 liters) of fuel are added to the vehicle.

- The fuel economy and distance to empty may vary significantly based on driving conditions, driving habits, and condition of the vehicle.

### Outside temperature gauge



This gauge indicates the current outside air temperatures by 1 °F (1 °C).

- Temperature range: -40 °F ~ 140 °F (-40 °C ~ 60 °C)

The outside temperature on the display may not change immediately like a general thermometer to prevent the driver from being inattentive.

To change the temperature unit (from °C to °F or from °F to °C)

The temperature unit can be changed by using the "User Settings" mode of the LCD Display.

\* For more details, refer to "LCD display" on page 4-68.

### Transmission shift indicator

Transmission shift indicator displays gear information depending on your vehicle's transmission type.

### Automatic transmission shift indicator

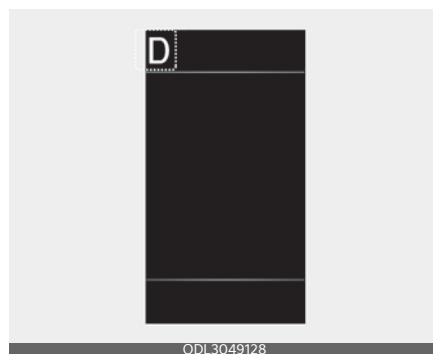

This indicator displays which automatic transmission shift lever is selected.

- Park: P
- Reverse: R
- Neutral: N
- Drive: D
- Sports Mode: 1, 2, 3, 4, 5, 6, 7, 8



4

## LCD display

The LCD display modes can be changed by using the control buttons.

### LCD display control



1.  : MODE button for changing modes
2.  : MOVE switch for changing items
3. OK : SELECT/RESET button for setting or resetting the selected item

### LCD display modes

You can switch modes by pressing the Mode button.

Mode						
	Trip Computer	Turn By Turn (TBT)*	Driving Assist	User Settings*	Information	Master warning
Up/Down	Fuel Economy	Route Guidance	Lane Keeping Assist/Smart Cruise Control/Navigation-based Smart Cruise Control/Lane Following Assist/Highway Driving Assist	Head-up display*	Speedometer	The Master Warning mode displays warning messages related to the vehicle when one or more systems is not operating normally.
	Accumulated Info	Destination Info		Driver Assistance	Tire Pressure	
	Drive Info			Door	Driving force distribution (AWD)*	
	Drive mode			Lights		
				Sound		
				Convenience		
				Service Interval		
				Other		
				Language		
				Reset		

The information provided may differ depending on which functions are applicable to your vehicle.

\* : if equipped

**\* NOTICE**

Keep the engine running when configuring the display settings to prevent the battery from discharging.

### Trip computer mode

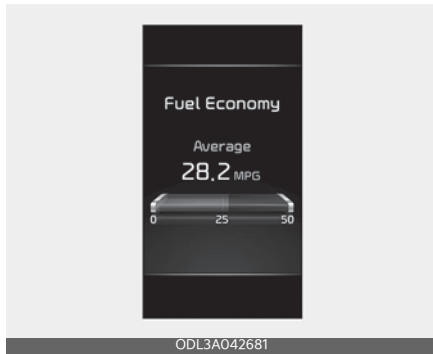

The trip computer mode displays information related to vehicle driving parameters including fuel economy, tripmeter information and vehicle speed.

\* For more details, refer to "Trip information (trip computer)" on page 4-78.

### Turn By Turn (TBT) mode (if equipped)



This mode displays the state of the navigation.

### Driving Assist mode



This mode displays the state of:

- Lane Keeping Assist
- Smart Cruise Control (if equipped)
- Navigation-based Smart Cruise Control (if equipped)
- Lane Following Assist
- Highway Driving Assist (if equipped)

- Driver Attention Warning

\* For more details, refer to each system information in "Driving your vehicle" on page 5-3.

## Information mode

### Digital speedometer

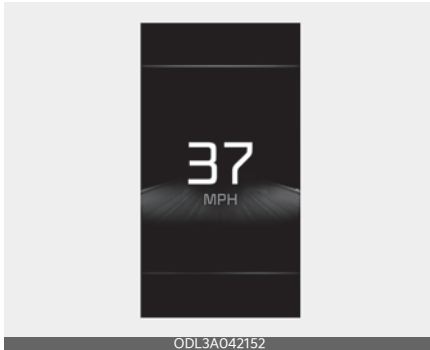

This digital speedometer display shows the speed of the vehicle.

### Tire Pressure

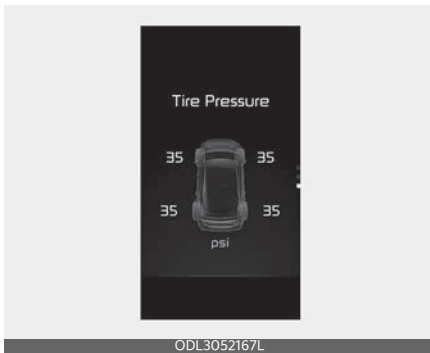

This mode displays information related to Tire Pressure.

\* For more details, refer to "Tire Pressure Monitoring System (TPMS)" on page 7-8.

### Driving force distribution (AWD) (if equipped)



This mode displays information related to Driving force distribution.

### Master warning mode

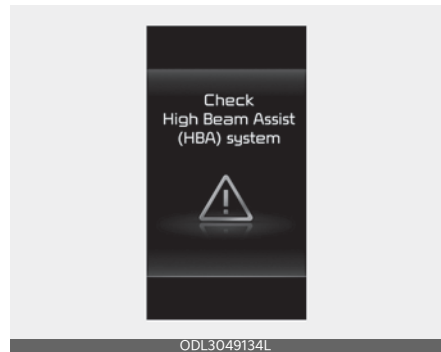



This warning light informs the driver the following situations.

- Forward Collision-Avoidance Assist malfunction
- Forward Collision-Avoidance Assist radar blocked
- Blind-Spot Collision-Avoidance Assist malfunction
- Blind-Spot Collision-Avoidance Assist radar blocked
- High Beam Assist malfunction
- Smart Cruise Control malfunction



- Smart Cruise Control radar blocked
- Lamp malfunction

At this time, a Master Warning icon  will appear beside the User Settings icon , on the LCD display. If the warning situation is solved, the master warning light will be turned off and the Master Warning icon will disappear.

## User Settings mode

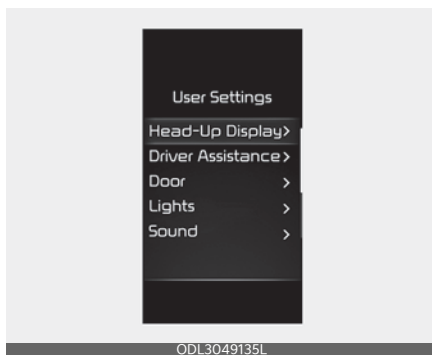

In this mode, you can change the settings of the instrument cluster, doors, lamps, etc.

1. Head-up display
2. Driver Assistance
3. Door
4. Lights
5. Sound
6. Convenience
7. Service Interval
8. Other
9. Language
10. Reset

The information provided may differ depending on which functions are applicable to your vehicle.

## 1. Head-Up Display (if equipped)

Items	Explanation
Enable Head-up display	If this item is checked, Head-Up Display will be activated.
Display Height	Adjust the height (1~20) of the HUD image on the HUD screen.
Rotation	Adjust the degree (-5~+5) of the HUD rotation.
Brightness	Adjust the intensity (1~20) of the HUD brightness.
Content Selection	If below items are checked, the items will be activated. Turn by Turn/Traffic Signs/Driving Assist Info/Lane Safety Info/Blind-Spot Safety Info
Speed Size	To select the size of number of the head-up display on the windshield
Speed Color	To select the color of speedometer of head-up display on the windshield

\* The information provided may differ depending on which systems are applicable to your vehicle.

## 2. Driver Assistance (if equipped)

Items	Explanation
Warning Timing	<ul style="list-style-type: none"> <li>Standard/Late</li> </ul> To select the Warning Timing.
Warning Volume	<ul style="list-style-type: none"> <li>High/Medium/Low</li> </ul> To select the Warning Volume.
Driver Attention Warning	<ul style="list-style-type: none"> <li>Leading vehicle departure alert</li> <li>Inattentive Driving Warning</li> </ul> To select the function. * For more details, refer to "Driver Attention Warning (DAW)" on page 6-57
Forward Safety	<ul style="list-style-type: none"> <li>Active Assist/Warning Only/Off</li> </ul> To select the functions. * For more details, refer to "Forward Collision-Avoidance Assist (FCA) (Front view camera only)" on page 6-4 or "Forward Collision-Avoidance Assist (FCA) (Sensor fusion) (if equipped)" on page 6-16.
Lane Safety	<ul style="list-style-type: none"> <li>Lane Keeping Assist/Lane Departure Warning/Off</li> </ul> To select the functions. * For more details, refer to "Lane Keeping Assist (LKA)" on page 6-31.

Items	Explanation
Blind-Spot Safety	<ul style="list-style-type: none"> <li>• Safe Exit Warning To select the function. * For more details, refer to "Safe Exit Warning (SEW) (if equipped)" on page 6-48.</li> <li>• Safe Exit Assist To select the function. * For more details, refer to "Safe Exit Assist (SEA) (if equipped)" on page 6-52.</li> <li>• Active Assist/Warning Only/Off To select the function. * For more details, refer to "Blind-Spot Collision-Avoidance Assist (BCA) (if equipped)" on page 6-37.</li> </ul>
Parking Safety	<ul style="list-style-type: none"> <li>• Parking Distance Warning Auto ON To select the function. * For more details, refer to "Forward/Reverse Parking Distance Warning (PDW) (if equipped)" on page 6-114.</li> <li>• Rear Cross-Traffic Safety To select the function. * For more details, refer to "Rear Cross-Traffic Collision-Avoidance Assist (RCCA) (if equipped)" on page 6-119.</li> <li>• Rear Active Assist/Rear Warning Only/Off To select the function. * For more details, refer to "Reverse Parking Collision-Avoidance Assist (PCA) (if equipped)" on page 6-130.</li> </ul>

\* The information provided may differ depending on which systems are applicable to your vehicle.

### 3. Door (if equipped)

Items	Explanation
Auto Lock	<ul style="list-style-type: none"> <li>• Enable on speed: All doors will be automatically locked when the vehicle speed exceeds 9.3 mph (15 km/h)</li> <li>• Enable on Shift : All doors will be automatically locked if the vehicle is shifted from the P (Park) position to the R (Reverse), N (Neutral), or D (Drive) position (with engine ON, it is activated).</li> </ul>
Auto Unlock	<ul style="list-style-type: none"> <li>• Off: The auto door unlock operation will be canceled.</li> <li>• Vehicle Off: All doors will be automatically unlocked when the ENGINE START/ STOP button is set to the OFF position.</li> <li>• On shift to P : All doors will be automatically unlocked if the gear is shifted to the P (Park) position (with engine ON, it is activated).</li> </ul>
2 Press Unlock	If this item is checked, the two press unlock will be activated. Press the door unlock button once to unlock the driver's door, and press the button once more within 4 seconds to unlock the rest of the doors.
Horn Feedback	If this item is checked, Horn Feedback will be activated.
Smart Trunk	To activate or deactivate the smart trunk. * For more details, refer to "Smart Trunk (if equipped)" on page 4-28.

\* The information provided may differ depending on which systems are applicable to your vehicle.

### 4. Lights

Items	Explanation
One Touch Turn Signal	<ul style="list-style-type: none"> <li>• Off: The one touch turn signal function will be deactivated.</li> <li>• 3, 5, 7 flashes: The turn signal indicator will blink 3, 5, or 7 times when the turn signal lever is moved slightly.</li> </ul> <p>* For more details, refer to "Lighting" on page 4-95.</p>
Headlight Delay	If this item is checked, the head lamp delay function will be activated.
High Beam Assist	If this item is checked, High Beam Assist will be activated. * For more details, refer to "High Beam Assist (HBA)" on page 4-99.

\* The information provided may differ depending on which functions are applicable to your vehicle.

### 5. Sound

Items	Explanation
Welcome Sound	If this item is checked, the welcome sound function will be activated.

\* The information provided may differ depending on which functions are applicable to your vehicle.

## 6. Convenience (if equipped)

Items	Explanation
Seat Easy Access	<ul style="list-style-type: none"> <li>Off/Normal/Extended</li> </ul> To select the seat movement.
Rear Occupant Alert	If this item is checked, the Rear Occupant Alert (ROA) display will be activated.
Oil Change Reminder	If this item checked, the oil change reminder will be activated.
Welcome Mirror/Light	<ul style="list-style-type: none"> <li>On door unlock / On driver approach</li> </ul> To select the welcome mirror/light function.
Wireless Charging System	If this item is checked, the wireless charging function will be activated.
Traffic Signs	If this item is checked, the traffic signs display will be activated.
Wiper/Lights Display	If this item is checked, the wiper/lights display will be activated.
Icy Road Warning	If this item is checked, the icy road warning will be activated.
Vehicle Auto-Shut Off	<ul style="list-style-type: none"> <li>60 min/30 min: To set the vehicle auto-shut off timer</li> <li>Disable: The vehicle auto-shut off function will be canceled.</li> </ul> * For more details, refer to "Vehicle Auto Shut-off system" on page 5-43.

\* The information provided may differ depending on which functions are applicable to your vehicle.

## 7. Service interval

Items	Explanation
Enable Service Interval	If this item is checked, the Service Interval function will be activated.
Adjust Interval	If the service interval menu is activated, you may adjust the time and distance.
Reset	To reset the service interval function.

### \* NOTICE

To use the service interval menu, consult an authorized Kia dealer.

If the service interval is activated and the time and distance is adjusted, messages are displayed in the following situations each time the vehicle is turned on.

- Service in: Displayed to inform the driver the remaining mileage and days to service.
- Service required: Displayed when the mileage and days to service has been reached or passed.

If any of the following conditions occur, the mileage and number of days to service may be incorrect.

- The battery cable is disconnected.
- The battery is discharged.

### 8. Other (if equipped)

Items	Explanation
Fuel Economy Auto Reset	<ul style="list-style-type: none"> <li>• Off: The average fuel economy will not reset.</li> <li>• After ignition / After refueling: The average fuel economy will reset automatically after ignition/refueling.</li> </ul>
Speedometer Unit	<ul style="list-style-type: none"> <li>• MPH, km/h</li> </ul> To select the Speedometer unit.
Fuel Economy Unit	<ul style="list-style-type: none"> <li>• US gallon, UK gallon or L/100km, km/L</li> </ul> To select the Fuel economy unit. * For more details, refer to "Trip information (trip computer)" on page 4-78.
Temperature Unit	<ul style="list-style-type: none"> <li>• °F/°C</li> </ul> To select the Temperature unit.
Tire Pressure Unit	<ul style="list-style-type: none"> <li>• psi, kPa, bar</li> </ul> To select the Tire Pressure Unit

\* The information provided may differ depending on which functions are applicable to your vehicle.

### 9. Language

Items	Explanation
Language	To select language.

### 10. Reset

Items	Explanation
Reset	You can reset the menus in the User Settings mode. All menus in the User Settings mode are reset to factory settings, except language and service interval.

### Trip information (trip computer)

The trip computer is a microcomputer-controlled driver information system that displays information related to driving.

#### \* NOTICE

Some driving information stored in the trip computer resets if the battery is disconnected.

### Trip Modes

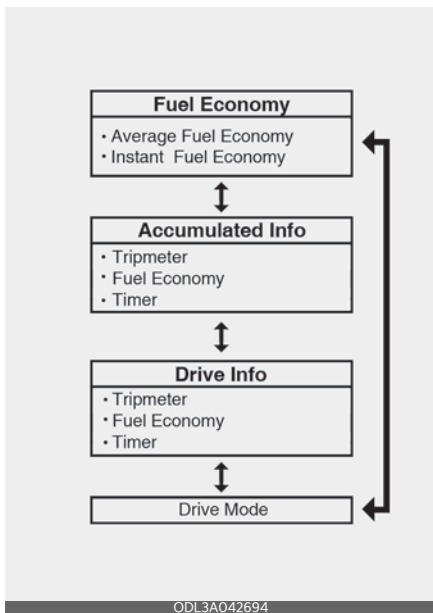

To change the trip mode, scroll the toggle the switch  $\wedge / \vee$  on the steering wheel.

### Fuel economy

#### Average Fuel Economy (1)

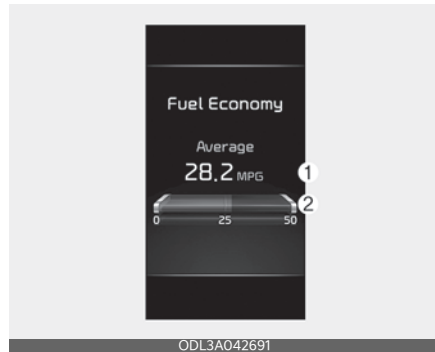

- The average fuel economy is calculated by the total driving distance and fuel consumption since the last average fuel economy reset.
  - Fuel economy range: 0 ~ 99.9 MPG or L/100km, km/L
- The average fuel economy can be reset both manually and automatically.

#### Manual reset

To clear the average fuel economy manually, press the OK button on the steering wheel for more than 1 second when the average fuel economy is displayed.

#### Automatic reset

To make the average fuel economy be reset automatically whenever refueling, select the "Fuel Economy Auto Reset" mode in User Setting menu of the LCD display (Refer to "User Settings mode" on page 4-72).

- OFF - You may set to default manually by using the trip switch reset button.

- After ignition - The vehicle will automatically set to default once 4 hours pass after the Ignition is in OFF.
- After refueling - After refueling more than 1.6 gallons (6 liters) and driving over 1 mph (1 km/h), the vehicle will reset to default automatically.

### \* NOTICE

The average fuel economy is not displayed for more accurate calculation if the vehicle does not drive more than 10 seconds or 0.19 miles (300 meters) after the ENGINE START/STOP button is turned to ON.

### Instant Fuel Economy (2)

- This mode displays the instant fuel economy during the last few seconds when the vehicle speed is more than 5 MPH (8 km/h).
  - Fuel economy range:  
0~50 MPG or 0~30 L/100km, km/L

### Accumulated driving information mode

This display shows the accumulated trip distance (1), the average fuel efficiency (2), and the total driving time (3).

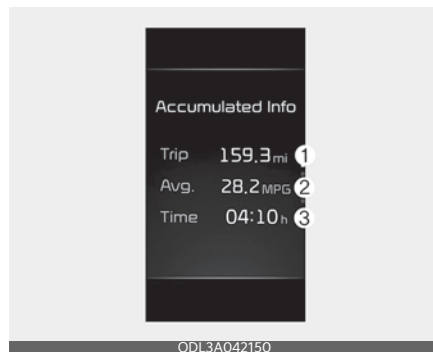

- Accumulated information is calculated after the vehicle has run for more than 0.19 miles (300 m).
- If you press "OK" button for more than 1 second after the Cumulative Information is displayed, the information will be reset.
- If the engine is running, even when the vehicle is not in motion, the information will be accumulated.



## Drive Info display

This display shows the trip distance (1), the average fuel efficiency (2), and the total driving time (3) information once per one ignition cycle.

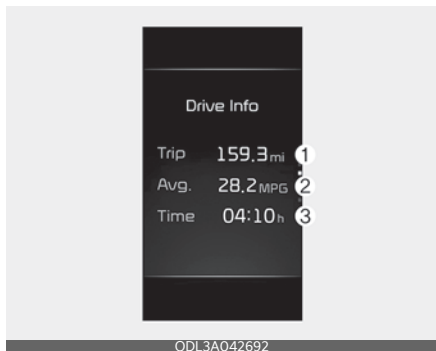

- Fuel efficiency is calculated after the vehicle has run for more than 0.19 miles (300 m).
- If opening the driver's door after turning off the engine or 3 minutes passes after restarting the engine, Driving Information is reset.
- If you press "OK" button for more than 1 second after the Driving Information is displayed, the information will be reset.
- If the engine is running, even when the vehicle is not in motion, the information will be accumulated.

### \* NOTICE

The vehicle must be driven for a minimum of 0.19 miles (300 m) since the last ignition cycle before the average accumulated driving information is recalculated.

## Service mode

This mode reminds you of scheduled maintenance information.

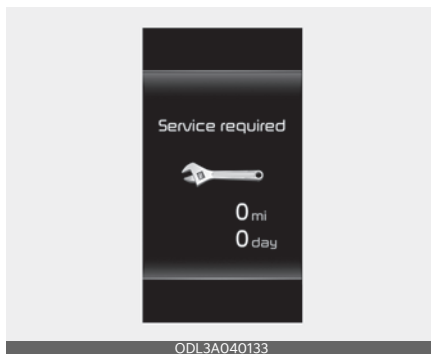

## Service in

It calculates and displays when you need a scheduled maintenance service (mileage or days).

If the remaining mileage or time reaches 900 miles (1,500 km) or 30 days, "Service in" message is displayed for several seconds each time you set the ENGINE START/STOP button to the ON position.

## Service required

If you do not have your vehicle serviced according to the already inputted service interval, "Service required" message is displayed for several seconds each time you set the ENGINE START/STOP button to the ON position.

To reset the service interval to the mileage and days you inputted before:

- Press the OK button (Reset) for more than 1 second.

### \* NOTICE

To use the service interval menu, consult an authorized Kia dealer.

**\* NOTICE**

If any of the following conditions occurs, the mileage and days may be incorrect.

- The battery cable is disconnected.
- The battery is discharged.

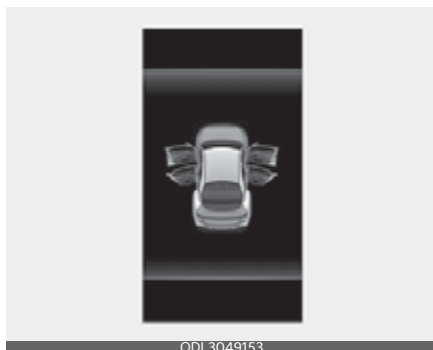
**LCD display messages****Door, hood, trunk, sunroof open**

- This warning is displayed indicating which door, the hood, the trunk or the sunroof is open.

**\* NOTICE**

Before driving the vehicle, you should confirm that the door/hood/trunk/sunroof is fully closed. Also, check there is no door/hood/trunk/sunroof open warning light or message displayed on the instrument cluster.

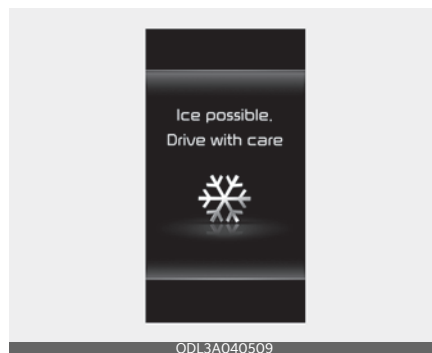
**Icy Road Warning (if equipped)**

This warning is to warn the driver the road may be icy.

When the following conditions occur, the warning light (including outside temperature gauge) blinks 5 times and then appears, and also warning chime sounds once.

- The temperature on the outside temperature gauge is below approximately 40 °F (4 °C).

**\* NOTICE**

If the icy road warning appears while driving, you should drive more attentively and refrain from speeding, rapid acceleration, sudden braking or sharp turning.

## Lights mode



This indicator displays which exterior light is selected using the lighting control.

You can activate or deactivate Wiper/Lights Display function from the User Settings mode in the cluster LCD display.

## Wiper mode



This indicator displays which wiper speed is selected using the wiper control.

You can activate or deactivate Wiper/Lights Display function from the User Settings mode in the cluster LCD display.

## Engine Overheated

- This warning message appears when the engine coolant temperature is above 248 °F (120 °C). This means that the engine is overheated and may be damaged.
- \* If your vehicle has overheated, refer to "If the engine overheats" on page 7-6.

## Low engine oil

- This warning message appears when the engine oil level is insufficient.
- Refill the engine oil.
- \* For more details, refer to "Engine oil and filter" on page 8-18.

### **⚠ WARNING**

When the engine oil level warning light occurs, it is necessary to check whether maintenance schedule (Engine oil replacement) in owner's manual has been followed before replenishing the oil, and if not followed, the engine oil must be replaced first.

## Engine oil change due soon. Reset oil life after oil change

- This warning message appears when the remaining engine oil life reaches 5% or below.
- Replace engine oil from an authorized Kia dealer. After that, select 'Convenience → Oil Change Reminder' from the User Settings menu on the cluster or 'Vehicle → Cluster → Oil Change Reminder' from Settings menu on the infotainment system screen to reset the remaining oil life.
- \* For more details, refer to "Engine oil and filter" on page 8-18.

### \* INFORMATION

The infotainment system may change after software updates. For more information, refer to the user's manual provided in the infotainment system and the quick reference guide.

#### Engine oil change due now. Reset oil life after oil change

- This warning message appears when the remaining engine oil life reaches 1% or below.
- Replace engine oil immediately from an authorized Kia dealer. After that, select 'Convenience → Oil Change Reminder' from the User Settings menu on the cluster or 'Vehicle → Cluster → Oil Change Reminder' from Settings menu on the infotainment system screen to reset the remaining oil life.

\* For more details, refer to "Engine oil and filter" on page 8-18.

### \* INFORMATION

The infotainment system may change after software updates. For more information, refer to the user's manual provided in the infotainment system and the quick reference guide.

#### Low key battery (for smart key system)

- This warning message appears if the battery of the smart key is discharged when the ENGINE START/STOP button changes to the OFF position.

#### Key not in vehicle (for smart key system)

- This warning message appears if the smart key is not in the vehicle when you press the ENGINE START/STOP button.
- It means that you should always have the smart key with you.

#### Key not detected (for smart key system)

- This warning message appears if the smart key is not detected when you press the ENGINE START/STOP button.

#### Shift to P or N to start engine (for smart key system)

- This warning message appears if you try to start the engine with the shift lever not in the P (Park) or N (Neutral) position.

#### Press brake pedal to start engine (for smart key system)

- This warning message appears if the ENGINE START/STOP button changes to the ACC position twice by pressing the button repeatedly without depressing the brake pedal.
- It means that you should depress the brake pedal to start the engine.

#### Battery discharging due to external electrical devices

The vehicle can detect self-discharge of the battery due to over-current that is generated by unauthorized electrical devices such as dashboard camera (dash cam) mounting during parking.

If the warning continues even after external electrical devices are removed, have your vehicle inspected by an authorized Kia dealer.

### Press start button again (for smart key system)

- This warning message appears if you cannot operate the ENGINE START/STOP button when there is a problem with the ENGINE START/STOP button system.
- It means that you could start the engine by pressing the ENGINE START/STOP button once more.
- If the warning appears each time you press the ENGINE START/STOP button, have the vehicle inspected by an authorized Kia dealer.

### Press start button with key (for smart key system)

- This warning message appears if you press the ENGINE START/STOP button while the warning message "Key not detected" is illuminating.
- At this time, the immobilizer indicator light blinks.

### Headlights are off

- This warning message appears if the headlights are off when the surrounding is dark.

## Warning and indicator lights

The warning light and indicator light indicate a situation where the driver should be careful and whether the various functions are activated.

### Warning lights

The warning light indicates situations that require the driver to pay attention.

#### \* NOTICE

### Warning lights

Make sure that all warning lights are OFF after starting the engine. If any light is still ON, this indicates a situation that needs attention.

### Air bag warning light

#### This warning light appears:

- Once you set the ENGINE START/STOP button to the ON position.
  - It appears for approximately 6 seconds and then goes off.
- When there is a malfunction with the SRS.
 

In this case, have the vehicle inspected by an authorized Kia dealer.

### Seat belt warning light

This warning light informs the driver that the seat belt is not fastened.

\* For more details, refer to "Seat belts" on page 3-17.

## Parking brake & brake fluid

### warning light BRAKE

#### This warning light appears:

- Once you set the ENGINE START/ STOP button to the ON position.
  - It appears for approximately 3 seconds
  - It remains on if the parking brake is applied.
- When the parking brake is applied.
- When the brake fluid level in the reservoir is low.
  - If the warning light appears with the parking brake released, it indicates the brake fluid level in reservoir is low.

#### If the brake fluid level in the reservoir is low:

1. Drive carefully to the nearest safe location and stop your vehicle.
2. With the engine stopped, check the brake fluid level immediately and add fluid as required (For more details, refer to "Brake fluid" on page 8-24). Then check all brake components for fluid leaks. If any leak on the brake system is found, the warning light remains on, or the brakes do not operate properly, do not drive the vehicle.

In this case, have your vehicle towed to an authorized Kia dealer and inspected.

## Dual-diagonal braking system

Your vehicle is equipped with dual-diagonal braking systems. This means you still have braking on two wheels even if one of the dual systems should fail.

With only one of the dual systems working, more than normal pedal travel and greater pedal pressure are required to stop the vehicle.

Also, the vehicle will not stop in as short a distance with only a portion of the brake system working.

If the brakes fail while you are driving, shift to a lower gear for additional engine braking and stop the vehicle as soon as it is safe to do so.

### \* NOTICE

#### Parking Brake & Brake Fluid Warning Light

Driving the vehicle with a warning light ON is dangerous. If the Parking Brake & Brake Fluid Warning Light appears with the parking brake released, it indicates that the brake fluid level is low.

In this case, have your vehicle inspected by an authorized Kia dealer.

## Anti-lock Brake System (ABS) warning light

### This warning light appears:

- Once you set the ENGINE START/ STOP button to the ON position.
  - It appears for approximately 3 seconds and then goes off.
- When there is a malfunction with the ABS (The normal braking system will still be operational without the assistance of the anti-lock brake system). In this case, have the vehicle inspected by an authorized Kia dealer.

## Electronic Brake Force Distribution (EBD) system warning light



### These two warning lights appear at the same time while driving:

- When the ABS and regular brake system are not working, have your vehicle inspected by an authorized Kia dealer.

## WARNING

### Electronic Brake Force Distribution (EBD) System Warning Light

When both ABS and Parking Brake & Brake Fluid Warning Lights are on, the brake system will not work normally and you may experience an unexpected and dangerous situation during sudden braking.

In this case, avoid high speed driving and abrupt braking.

Have your vehicle inspected by an authorized Kia dealer as soon as possible.

## Motor Driven Power Steering (MDPS) warning light

### This warning light appears:

- Once you set the ENGINE START/ STOP button to the ON position.
  - It appears for approximately 3 seconds and then goes off.
- When there is a malfunction with the MDPS. In this case, have the vehicle inspected by an authorized Kia dealer.

## Charging system warning light



### This warning light appears:

- Once you set the ENGINE START/ STOP button to the ON position.
- When there is a malfunction with either the alternator or electrical charging system.

### If there is a malfunction with either the alternator or electrical charging system:

1. Drive carefully to the nearest safe location and stop your vehicle.
2. Turn the engine off and check the alternator drive belt for looseness or breakage.

In this case, have the vehicle inspected by an authorized Kia dealer.

## Forward Safety warning light

### This indicator light appears:

- Once you set the ENGINE START/STOP button to the ON position.
  - It appears for approximately 3 seconds and then goes off.
- When there is a malfunction with Forward Collision-Avoidance Assist. In this case, have your vehicle inspected by an authorized Kia dealer.
- \* For more details, refer to "Forward Collision-Avoidance Assist (FCA) (Front view camera only)" on page 6-4/"Forward Collision-Avoidance Assist (FCA) (Sensor fusion) (if equipped)" on page 6-16.

## Electronic Parking Brake (EPB) warning light

### This warning light appears:

- Once you set the ENGINE START/STOP button to the ON position.
  - It appears for approximately 3 seconds and then goes off.
- When there is a malfunction with the EPB. In this case, have the vehicle inspected by an authorized Kia dealer.

### \* NOTICE

#### Electronic Parking Brake (EPB) Warning Light

The Electronic Parking Brake (EPB) Warning Light may appear when the Electronic Stability Control (ESC) Indicator Light comes on to indicate that the ESC is not working properly (This does not indicate malfunction of the EPB).

## Malfunction Indicator Lamp (MIL)

### This warning light appears:

- When you set the ENGINE START/STOP button to the ON position.
  - The malfunction indicator light appears for about 3 seconds and then goes off.
- Whenever there is a malfunction with either the emission control system or the engine or the vehicle powertrain. In this case, have the vehicle inspected by an authorized Kia dealer.



**⚠ CAUTION****Malfunction Indicator Lamp (MIL)**

- Driving with the Malfunction Indicator Lamp (MIL) on may cause damage to the emission control systems which could effect drivability and/or fuel economy.
- If the enhanced engine protection system becomes activated due to lack of engine oil, engine power will be limited. If such condition continues repeatedly, the Malfunction Indicator Lamp will appear.

**⚠ CAUTION**

If the Malfunction Indicator Lamp (MIL) appears, potential catalytic converter damage is possible which could result in loss of engine power. In this case, have the vehicle inspected by an authorized Kia dealer.

**Engine oil pressure warning light****This warning light appears:**

- When the engine oil pressure is low.
- Drive carefully to the nearest safe location and stop your vehicle.
- Turn the engine off and check the engine oil level (For more details, refer to "Engine oil and filter" on page 8-18"). If the level is low, add oil as required.
- If the warning light remains on after adding oil or if oil is not available, have the vehicle inspected by an authorized Kia dealer. Continued driving with the warning light on may cause engine failure.

**\* NOTICE**

- When engine oil pressure decreases due to insufficient engine oil, etc., the Engine Oil Pressure warning light will appear.
- The enhanced engine protection system which limits engine power will be activated. When the engine oil pressure is restored, the warning light and the enhanced engine protection system will turn off after the engine is restarted.

**Low fuel level warning light****This warning light appears:**

- When the fuel tank is nearly empty.

**If the fuel tank is nearly empty:**

- Add fuel as soon as possible.

**⚠ CAUTION****Low Fuel Level**

Driving with the Low Fuel Level warning light on or with the fuel level below "E" can cause the engine to misfire and damage the catalytic converter.

## Master warning light

### This indicator light appears:

- This warning light informs the driver the following situations
  - Forward Collision-Avoidance Assist malfunction
  - Forward Collision-Avoidance Assist radar blocked
  - Blind-Spot Collision-Avoidance Assist malfunction
  - Blind-Spot Collision-Avoidance Assist radar blocked
  - High Beam Assist malfunction
  - Smart Cruise Control malfunction
  - Smart Cruise Control radar blocked
  - Lamp malfunction

To identify the details of the warning look at the LCD display.

If the warning situation is solved, the master warning light will turn off.

## Low Tire Pressure warning light



### This warning light appears:

- Once you set the ENGINE START/ STOP button to the ON position.
  - It appears for approximately 3 seconds and then goes off.
- When one or more of your tires are significantly under inflated. (The location of the underinflated tires are displayed on the LCD display).

\* For more details, refer to "Tire Pressure Monitoring System (TPMS)" on page 7-8.

This warning light remains on after blinking for approximately 70 seconds or repeats blinking on and off at the intervals of approximately 3 seconds:

- When there is a malfunction with the TPMS.

In this case, have your vehicle inspected by an authorized Kia dealer as soon as possible.

\* For more details, refer to "Tire Pressure Monitoring System (TPMS)" on page 7-8.

## WARNING

### Low tire pressure

- Significantly low tire pressure makes the vehicle unstable and can contribute to loss of vehicle control and increased braking distances.
- Continued driving or low pressure tires will cause the tires to overheat and fail.

## WARNING

### Safe Stopping

- The TPMS cannot alert you to severe and sudden tire damage caused by external factors.
- If you notice any vehicle instability, immediately take your foot off the accelerator pedal, apply the brakes gradually with light force, and slowly move to a safe position off the road.

## LED Headlamp warning light (if equipped)

### This warning light appears:

- Once you set the ENGINE START/ STOP button to the ON position.
  - It appears for approximately 3 seconds and then goes off.
- When there is a malfunction with the LED headlamp.

In this case, have your vehicle inspected by an authorized Kia dealer.

### This warning light blinks:

- When there is a malfunction with a LED headlamp related part.

In this case, have your vehicle inspected by an authorized Kia dealer.

## CAUTION

### LED Headlamp Warning Light

Continuous driving with the LED Headlamp Warning Light on or blinking can reduce LED headlamp (low beam) life.

## All Wheel Drive (AWD) warning light (if equipped)

### This warning light appears:

- Once you set the ENGINE START/ STOP button to the ON position.
  - It appears for approximately 3 seconds and then goes off.
- When there is a malfunction with the AWD.

In this case, have your vehicle inspected by an authorized Kia dealer.

## Indicator lights

### Electronic stability control (ESC) indicator light

#### This indicator light appears:

- Once you set the ENGINE START/ STOP button to the ON position.
  - It appears for approximately 3 seconds and then goes off.
- When there is a malfunction with the ESC system.
 

In this case, have your vehicle inspected by an authorized Kia dealer.

#### This indicator light blinks:

- While the ESC is operating.
- \* For more details, refer to "Electronic Stability Control (ESC) system" on page 5-37.

### Electronic stability control (ESC) OFF indicator light

#### This indicator light appears:

- Once you set the ENGINE START/ STOP button to the ON position.
    - It appears for approximately 3 seconds and then goes off.
  - When you deactivate the ESC system by pressing the ESC OFF button.
- \* For more details, refer to "Electronic Stability Control (ESC) system" on page 5-37.

## Immobilizer indicator light (With Smart Key)

**This indicator light appears for up to 30 seconds:**

- When the vehicle detects the smart key in the vehicle properly while the ENGINE START/STOP button is ACC or ON.
  - At this time, you can start the engine.
  - The indicator light goes off after starting the engine.

**This indicator light blinks for a few seconds:**

- When the smart key is not in the vehicle.
  - At this time, you can not start the engine.

**This indicator light appears for 2 seconds and goes off:**

- When the vehicle can not detect the smart key which is in the vehicle while the ENGINE START/STOP button is ON.

In this case, have your vehicle inspected by an authorized Kia dealer.

**This indicator light blinks:**

- When the battery of the smart key is weak.
  - At this time, you can not start the engine. However, you can start the engine if you press the ENGINE START/STOP button with the smart key. (For more details, refer to "Immobilizer System" on page 4-12).
- When there is a malfunction with the immobilizer system.

In this case, have your vehicle inspected by an authorized Kia dealer.

**Turn signal indicator light **

**This indicator light blinks:**

- When you turn the turn signal light on. If any of the following occurs, there may a malfunction with the turn signal system. In this case, have your vehicle inspected by an authorized Kia dealer.
  - The indicator light does not blink but appears.
  - The indicator light blinks more rapidly.
  - The indicator light does not appear at all.

**Low beam indicator light  (if equipped)**

**This indicator light appears:**

- When the headlights are on.

**High beam indicator light **

**This indicator light appears:**

- When the headlights are on and in the high beam position.
- When the turn signal lever is pulled into the Flash-to-Pass position.

### High Beam Assist indicator light



#### This warning light appears:

- When the high beam is on with the light switch in the AUTO light position.
- If your vehicle detects oncoming or preceding vehicles, High Beam Assist will switch the high beam to low beam automatically.

\* For more details, refer to "High Beam Assist (HBA)" on page 4-99.

### Light ON indicator light

#### This indicator light appears:

- When the tail lights or headlights are on.

### Front fog indicator light (if equipped)

#### This indicator light appears:

- When the front fog lights are on.

### Lane Safety indicator light

#### This warning light appears:

- [Green] When Lane Keeping Assist operating conditions are satisfied.
- [Gray] When Lane Keeping Assist operating conditions are not satisfied.
- [Amber] Whenever there is a malfunction with Lane Keeping Assist.

In this case, have your vehicle inspected by an authorized Kia dealer.

\* For more details, refer to "Lane Keeping Assist (LKA)" on page 6-31.

### Cruise indicator light (if equipped)

#### This indicator light appears:

- When Cruise Control is enabled.
- \* For more details, refer to "Cruise Control (CC) (if equipped)" on page 6-65.

### AUTO HOLD indicator light

(AUTO HOLD) 

#### This indicator light appears:

- White: When you activate the auto hold system by pressing the AUTO HOLD button.
- Green: When you stop the vehicle completely by depressing the brake pedal with the auto hold system activated.
- Yellow: When there is a malfunction with the auto hold system. In this case, have your vehicle inspected by an authorized Kia dealer.

\* For more details, refer to "AUTO HOLD" on page 5-33.

### SPORT mode indicator light

 (if equipped)

#### This indicator light appears:

- When you select "SPORT" mode as drive mode.

For more details, refer to "Drive mode integrated control system" on page 5-44.

## Head-Up Display (HUD) (if equipped)

The Head-Up Display is a transparent display which projects a shadow of some information of the instrument cluster and navigation on the HUD screen.



- The Head-Up Display image on the HUD screen may be invisible when:
    - Sitting posture is bad.
    - Wearing polarized sunglasses.
    - There is an object on the cover of the Head-Up Display.
    - Driving on a wet road.
    - An inadequate lighting is turned on inside the vehicle.
    - Any light comes from the outside.
    - Wearing an inadequate glasses to your eyesight.
  - If the Head-Up Display image is not shown well, adjust the height, rotation or illumination of the Head-Up Display in the cluster.
  - When the Head-Up Display needs inspection or repair, have your vehicle inspected or repaired by an authorized Kia dealer.
- ⚠ WARNING**

**Head-Up Display**

  - Do not place any accessories on the Head-Up Display shutter. It might fall into Head-Up Display and can damage Head-Up Display.
  - Do not attach stickers or accessories to the Head-Up Display and the crash pad.
  - Do not manually adjust the shutter and combiner. The images may not be visible due to fingerprints. Excessive external force during operation may cause damage.
  - Do not place any objects near the Head-Up Display. Interference with the object during operation may damage it.
  - Do not place any objects around the Head-Up Display. It might enter the narrow gap of the cover and affects operation.
  - Do not place any liquids around the Head-Up Display. Water or other liquids can flow into the Head-Up Display and break it.
  - Do not expose the combiner to strong light. The combiner may become deformed.
  - Do not use organic solvents, detergents or abrasive cloths to clean the Head-Up Display. Wipe it off with a soft cloth. Do not strongly wipe Head-Up Display shutter. It might get damaged.
  - For safety, be sure to adjust the settings when the vehicle is stopped.
  - When opening, closing and height adjusting the Head-Up Display, noise may be generated by the motor and gear.

### Head-Up Display Information



1. Turn By Turn navigation information (if equipped)
2. Road signs
3. Speedometer
4. SCC set speed (if equipped)
5. SCC vehicle distance information (if equipped)
6. Lane Safety information
7. Blind-Spot Safety information
8. Warning lights (Low fuel)
9. AV mode information
10. Lane Following Assist information
11. Highway Driving Assist (if equipped)
12. Highway Auto Speed Change (if equipped)

**\* NOTICE**

Road Signs and Turn By Turn navigation information are available depending on the region.

### Head-Up Display Setting

On the LCD display, you can change the Head-Up Display settings as follows.

1. Display height
2. Rotation
3. Brightness
4. Content selection
5. Speed Size
6. Speed Color

\* For more details, refer to "LCD display modes" on page 4-69.

## Lighting

This vehicle is equipped with a variety of lights to illuminate the interior and exterior of the vehicle.

### CAUTION

To prevent the battery from being discharged, do not leave the headlight and interior light on for a prolonged time while the engine is not running.

### Battery saver function

The purpose of this feature is to prevent the battery from being discharged if the lights are left in the ON position. The system automatically shuts off the position lamps after the engine is off and the driver's door is opened.

However, the position lamps stay ON even when the driver-side door is opened if the light switch is operated after the engine is turned off.

If necessary, to keep the lamps on turn the position lamps OFF and ON again using the headlamp switch on the steering column after the engine is turned off.

### Headlamp delay function (if equipped)

If you place the ENGINE START/STOP button in the ACC or OFF position with the headlamps ON, the headlamps (and/or position lamps) remain on for about 5 minutes. However, with the engine off if the driver's door is opened and closed, the headlamps (and/or position lamps) are turned off after 15 seconds.

The headlamps (and/or position lamps) can be turned off by pressing the lock button on the remote key or smart key twice or turning the light switch to the OFF or AUTO position. However, if you turn the light switch to the AUTO posi-

tion when it is dark outside, the headlamps will not be turned off.

You can activate or deactivate the Headlamp Delay function from the User Settings Mode in the LCD display. For more details, refer to "LCD display modes" on page 4-69. If your vehicle is equipped with an infotainment system, you can learn how to setup on the website via QR code in the infotainment quick reference guide.

### \* INFORMATION

The infotainment system may change after software updates. For more information, refer to the user's manual provided in the infotainment system and the quick reference guide.

### \* NOTICE

If the driver exits the vehicle through another door besides the driver door, the battery saver function does not operate and the headlamp delay function does not turn OFF automatically.

This may cause the battery to discharge. To avoid battery discharge, turn OFF the headlamps manually from the headlamp switch before exiting the vehicle.

### Daytime Running Light (DRL)

The Daytime Running Light (DRL) can make it easier for others to see the front of your vehicle during the day.

The DRL can be helpful in many different driving conditions, and it is especially helpful after dawn and before sunset.

The DRL will turn the dedicated lamp OFF when:

- The headlight switch is on.
- The vehicle is off.
- The front fog light is on. (if equipped)



- Engaging the Parking Brake.

### Lighting control

The light switch has a headlight and a position lamp position.



ODL3H041091

To operate the lights, turn the knob at the end of the control lever to one of the following positions:

1. OFF position
2. Auto light position
3. Position & Tail lamp
4. Headlight position

### Position & Tail lamp



ODL3H041409

When the light switch is in the position lamp position, the front position lamp and auxiliary lamp (if equipped), tail, license light will turn ON.

### \* NOTICE

Auxiliary lamp will be ON only in position lamp  condition.

### Head light (Low Beam)



ODL3H041410

When the light switch is in the head light position, head light (low beam), tail, license light will turn ON.

### \* NOTICE

The ENGINE START/STOP button must be in the ON position to turn on the headlights.

## Auto light

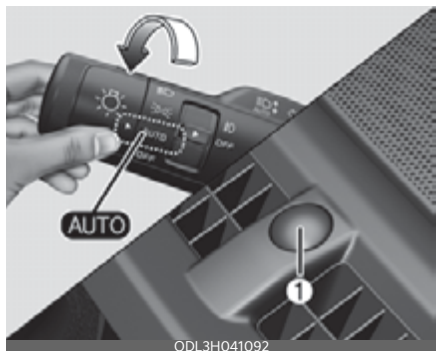

When the light switch is in the AUTO light position, the taillights and headlights will turn ON or OFF automatically depending on the amount of light outside the vehicle.

### ⚠ CAUTION

- Never place anything over the sensor (1) located on the instrument panel as this will ensure better auto-light system control.
- Don't clean the sensor using a window cleaner, the cleaner may leave a light film which could interfere with sensor operation.
- If your vehicle has window tint or other types of metallic coating on the front windshield, the Auto light system may not work properly.

## Operating high beam



To turn on the high beam headlight:

- Push the lever away from you.  
The lever will return to its original position.  
The high beam indicator will light when the headlight high beams are switched on.

### ⚠ WARNING

#### High beams

Do not use high beam when there are other vehicles in front of or approaching your vehicle. Using high beam could obstruct the other driver's vision.

To flash the headlights:

- Pull the lever towards you.

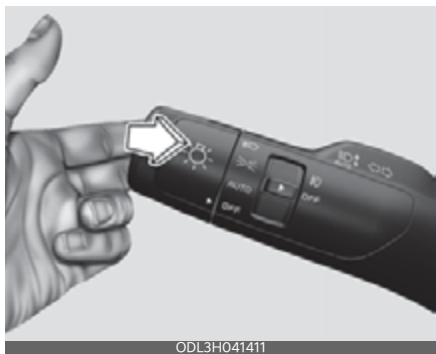

ODL3H041411

It will return to the normal (low beam) position when released. The headlight switch does not need to be on to use this flashing feature.

### Operating turn signals and lane change signals

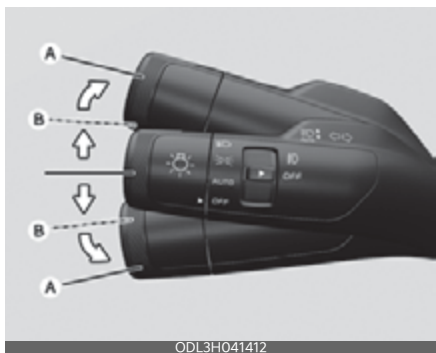

ODL3H041412

The ENGINE START/STOP button must be on for the turn signals to function.

To turn on the turn signals:

- Move the lever up or down (A).  
The green arrow indicators on the instrument panel indicate which turn signal is operating.  
They will self-cancel after a turn is completed. If the indicator continues

to flash after a turn, manually return the lever to the OFF position.

To signal a lane change:

- Move the turn signal lever slightly and hold it in position (B).

The lever will return to the OFF position when released.

If an indicator stays on and does not flash or if it flashes abnormally, one of the turn signal bulbs may be burned out and will require replacement.

#### \* NOTICE

If an indicator flash is abnormally quick or slow, a bulb may be burned out or have a poor electrical connection in the circuit. The bulb may require replacement.

### One-touch lane change function

To activate a one-touch lane change function, move the turn signal lever slightly and then release it. The lane change signals will blink 3, 5 or 7 times. You can activate or deactivate the One Touch Turn Signal function or choose the number of blinking (3, 5, or 7) by selecting "User Settings → Lights → One Touch Turn signal".

#### \* NOTICE

If the turn signal indicator stays on and does not flash, or if it flashes abnormally, a bulb may be burned out or have a poor electrical connection in the circuit. The bulb may require replacement.

## Operating front fog light (if equipped)

Fog lights are designed to provide improved visibility when visibility is poor due to fog, rain or snow, etc.



ODL3A042473

The fog lights will turn on when the fog light switch (1) is turned to the on position after the headlight is turned on.

To turn off the fog lights:

- Turn the fog light switch (1) to the OFF position.

### \* NOTICE

When in operation, the fog lights consume large amounts of vehicle electrical power. Only use the fog lights when visibility is poor.

## High Beam Assist (HBA)



ODL3H041093

High Beam Assist is a function that automatically adjusts the headlamp range (switches between high beam and low beam) depending on the brightness of detected vehicles and certain road conditions.

## Detecting sensor



ODL3A052361

[1]: Front view camera

The front view camera is used as a detecting sensor to detect ambient light and brightness while driving.

Refer to the picture for the detailed location of the detecting sensor.

## \* NOTICE

- Always keep the front view camera in good condition to maintain optimal performance of High Beam Assist.
- For more details on the precautions of the front view camera, refer to "Forward Collision-Avoidance Assist (FCA) (Front view camera only)" on page 6-4.

## High Beam Assist setting

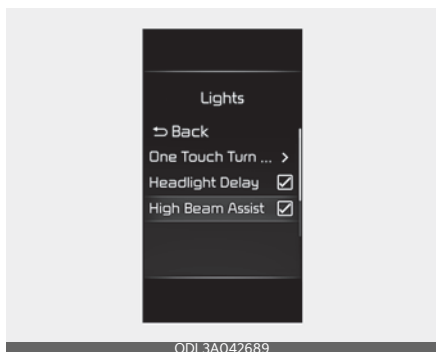



With the ENGINE START/STOP button in the ON position, select 'Lights → High Beam Assist' from the Settings menu to turn on High Beam Assist and deselect to turn off the function.

## ⚠ WARNING

For your safety, change the Settings after parking the vehicle at a safe location.

## High Beam Assist operation

### Display and control

- After selecting 'High Beam Assist' in the Settings menu, High Beam Assist will operate by following the procedure below.
  - Place the headlamp switch in the AUTO position and push the headlamp lever towards the instrument cluster. High Beam Assist  indicator light will appear on the cluster and the function will be enabled.
  - When the function is enabled, high beam will turn on when vehicle speed is above 25 mph (40 km/h). When vehicle speed is below 15 mph (25 km/h), high beam will not turn on.
  - The High Beam  indicator light will appear on the cluster when high beam is on.
- When High Beam Assist is operating, if the headlamp lever or switch is used, the function operates as follow:
  - If the headlamp lever is pulled towards you when the high beam is off, the high beam will turn on without High Beam Assist canceled. When you let go of the headlamp lever, the lever will move to the middle and the high beam will turn off.
  - If the headlamp lever is pulled towards you when the high beam is on by High Beam Assist, low beam will be on and the function will turn off.
  - If the headlamp switch is placed from AUTO to another position (headlamp/position/off), High

- Beam Assist will turn off and the corresponding lamp will turn on.
- When High Beam Assist is operating, high beam switches to low beam if any of the following conditions occur:
    - When the headlamp of an oncoming vehicle is detected.
    - When the tail lamp of a vehicle in front is detected.
    - When the headlamp or tail lamp of a motorcycle or a bicycle is detected.
    - When the surrounding ambient light is bright enough that high beams are not required.
    - When streetlights or other lights are detected.

## High Beam Assist malfunction and limitations

### High Beam Assist malfunction

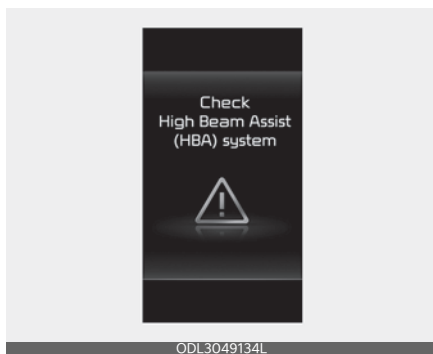

When High Beam Assist is not working properly, the 'Check High Beam Assist (HBA) system' warning message will appear and  warning light will appear on the cluster. In this case, have the function inspected by an authorized Kia dealer.

## Limitations of High Beam Assist

High Beam Assist may not work properly in the following situations:

- Light from a vehicle is not detected because of lamp damage, or because it is hidden from sight, etc.
- Headlamp of a vehicle is covered with dust, snow or water.
- A vehicle's headlamps are off but the fog lamps are on and etc.
- There is a lamp that has a similar shape as a vehicle's lamp.
- Headlamps have been damaged or not repaired properly.
- Headlamps are not aimed properly.
- Driving on a narrow curved road, rough road, uphill or downhill.
- Vehicle in front is partially visible on a crossroad or curved road.
- There is a traffic light, reflecting sign, flashing sign or mirror ahead.
- There is a temporary reflector or flash ahead (construction area).
- The road conditions are bad such as being wet, iced or covered with snow.
- A vehicle suddenly appears from a curve.
- The vehicle is tilted from a flat tire or is being towed.
- Light from a vehicle is not detected because of exhaust fume, smoke, fog, snow, etc.

### \* NOTICE

Depending on the instrument cluster specification or theme, images or colors may be displayed differently.

For more details on the limitations of the front view camera, refer to "Forward Collision-Avoidance Assist (FCA) (Front view camera only)" on page 6-4.

### \* NOTICE

- At times, High Beam Assist may not work properly. The function is for your convenience only. It is the responsibility of the driver for safe driving practices and always check the road conditions for your safety.
- When High Beam Assist does not operate normally, change the headlamp position manually between high beam and low beam.

## Wipers and washers

The wipers and washers remove foreign substances from the windshield and rear window, helping to maintain visibility.

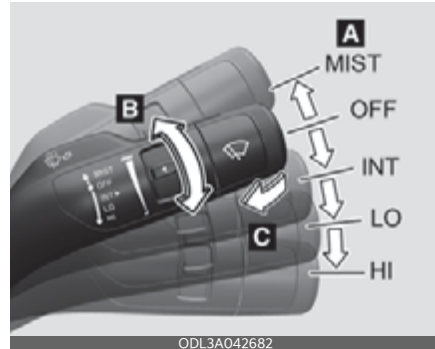

### A: Wiper speed control

- MIST - Single wipe
- OFF - Off
- INT - Intermittent wipe
- LO - Low wiper speed
- HI - High wiper speed

### B: Intermittent control wiper time adjustment/Auto control wiper time adjustment\*

### C: Wash with brief wiper

### \* NOTICE

If there is heavy accumulation of snow or ice on the windshield, defrost the windshield for about 10 minutes, or until the snow and/or ice is removed before using the windshield wipers to ensure proper operation. If you do not remove the snow and/or ice before using the wiper and washer, it may damage the wiper and washer system.

**⚠ WARNING**

Do not use the washer in freezing temperatures without first warming the windshield with the defrosters; the washer solution could freeze on the windshield and obscure your vision.

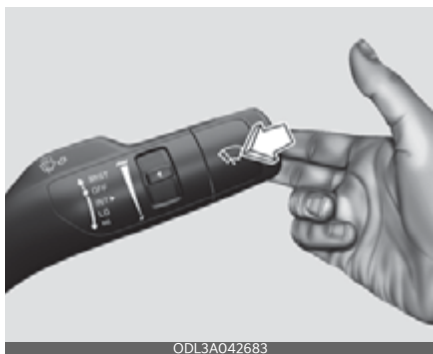
**Operating windshield washers**

1. Move the wiper speed control switch to the OFF position.
2. Pull the lever gently toward you to spray washer fluid on the windshield and to run the wipers 1-3 cycles. Use this function when the windshield is dirty. The spray and wiper operation will continue until you release the lever.

If the washer does not work, check the washer fluid level. If the fluid level is not sufficient, you will need to add appropriate non-abrasive windshield washer fluid to the washer reservoir.

The reservoir filler neck is located in the front of the engine compartment on the passenger side.

**⚠ CAUTION****Washer pump**

To prevent possible damage to the washer pump, do not operate the washer when the fluid reservoir is empty.

**⚠ CAUTION**

- To prevent possible damage to the wipers or windshield, do not operate the wipers when the windshield is dry.
- To prevent damage to the wiper blades, do not use gasoline, kerosene, paint thinner, or other solvents on or near them.
- To prevent damage to the wiper arms and other components, do not attempt to move the wipers manually.
- To prevent possible damage to the wipers and washer system, use anti-freezing washer fluids in the winter season or cold weather.



## Welcome system (if equipped)

The welcome system is a function that illuminates the surroundings or the interior when the driver approaches or exits the vehicle.

## Door handle lamp (if equipped)



When all the doors (and trunk) are closed and locked, the door handle lamp will come on for about 15 seconds if any of the below is performed.

- When the door unlock button is pressed on the remote key or smart key.
- When the button of the outside door handle is pressed.
- When the vehicle is approached with the smart key in possession.

## Headlight (headlamp) escort function

The headlights (and/or taillights) remain on for approximately 5 minutes after the vehicle is turned off. However, if the driver's door is opened and closed, the headlights are turned off after 15 seconds.

The headlights can be turned off by pressing the lock button on the smart key twice or turning off the light switch from the headlight or Auto light position.

## Interior light

When the interior light switch is in the DOOR position and all doors (and trunk) are locked and closed, the room lamp will come on for 30 seconds if any of the following occurs:

- With the smart key system
  - When the door unlock button is pressed on the smart key.
  - When the button of the outside door handle is pressed.

At this time, if you press the door lock button, the lamps will turn off immediately.

## Interior lights

This vehicle is equipped with lights throughout the vehicle to illuminate the interior.

### \* NOTICE

Do not use the interior lights for extended periods when the engine is not running.

It may cause battery discharge.

### ⚠ WARNING

Do not use the interior lights when driving in the dark. Accidents could happen because the view may be obscured by interior lights.

### Automatic turn off function

The interior lights automatically turn off approximately 20 minutes after the ENGINE START/STOP button is turned off, if the lights are in the ON position.

If your vehicle is equipped with the theft alarm system, the interior lights automatically turn off approximately 5 seconds after the system is armed.

### Map lamp

Type A



Type B



- Press the lens (1) to turn ON the map lamp.  
To turn the map lamp OFF press the lens (1) again.
-  (2): DOOR mode
  - The map lamp and room lamp come on when a door is opened. The lamps go out after approximately 30 seconds.
  - The map lamp and room lamp come on for approximately 30 seconds when doors are unlocked with a smart key as long as the doors are not opened.
  - The map lamp and room lamp will stay on for approximately 20 minutes if a door is opened with the ENGINE START/STOP button in the ACC or OFF position.
  - The map lamp and room lamp will stay on continuously if the door is opened with the ENGINE START/STOP button in the ON position.
  - The map lamp and room lamp will go out immediately if the ENGINE START/STOP button is changed to the ON position or all doors are locked.

- To turn off the DOOR mode, press the DOOR button (2) once again (not pressed).
- 3 (3): Press this switch to turn the front and rear room lamps on and off.

**\* NOTICE**

The DOOR mode and ROOM mode can not be selected the same time.

**Room lamp (if equipped)**

Type A



Type B



Personal lamp



Press the switch to turn the room lamp on and off.

**Luggage room lamp**



The luggage room lamp comes on when the trunk is opened.

**⚠ CAUTION**

The luggage room lamp comes on as long as the trunk opens. To prevent unnecessary charging system drain, close the trunk securely after using the luggage room.

## Vanity mirror lamp



Opening the lid of the vanity mirror will automatically turn on the mirror light.

### ⚠ CAUTION

#### Vanity mirror lamp

Always close the lid of the vanity mirror in the off position when the vanity mirror lamp is not in use. If the sun visor is closed without the lamp off, it may discharge the battery or damage the sun visor.

## Climate control system



The climate control system uses cooling and heating to help maintain a pleasant environment inside the vehicle.

### System operation

#### Ventilation

1. Set the mode to the  position.
2. Set the air intake control to the outside (fresh) air position.
3. Set the temperature control to the desired position.
4. Set the fan speed control to the desired speed.

#### Heating

1. Set the mode to the  position.
2. Set the air intake control to the outside (fresh) air position.
3. Set the temperature control to the desired position.
4. Set the fan speed control to the desired speed.
5. If dehumidified heating is desired, turn the air conditioning system on.
  - If the windshield fogs up, set the mode to the  or  position.

#### Operation tips

- To keep dust or unpleasant fumes from entering the vehicle through the ventilation system, temporarily set the air intake control to the recirculated air position. Be sure to return the control to the fresh air position when the irritation has passed to keep fresh air in the vehicle. This will help keep the driver alert and comfortable.

- Air for the heating/cooling system is drawn in through the grilles just at the base of the windshield. Care should be taken that these are not blocked by leaves, snow, ice or other obstructions.
- To prevent fog from forming on the inside of the windshield:
  - Set the air intake control to the fresh air position and the fan speed to the desired position.
  - Turn on the air conditioning system, and adjust the temperature control to desired temperature.

### Air conditioning (A/C)

All Kia air conditioning systems are filled with R-1234yf refrigerant.

1. Start the vehicle. Press the A/C button.
2. Set the mode to the  position.
3. Set the air intake control to the outside-air or recirculated air position.
4. Adjust the fan speed control and temperature control to maintain maximum comfort.

#### **CAUTION**

- The refrigerant system should only be serviced by trained and certified technicians to insure proper and safe operation.
- The refrigerant system should be serviced in a well-ventilated place.
- The air conditioning evaporator (cooling coil) shall never be repaired or replaced with one removed from a used or salvaged vehicle and new replacement MAC evaporators shall be certified (and labeled) as meeting SAE Standard J2842.

#### **CAUTION**

##### Excessive air conditioning use

- When using the air conditioning system, monitor the temperature gauge closely while driving up hills or in heavy traffic when outside temperatures are high. Air conditioning system operation may cause engine overheating. Continue to use the blower fan but turn the air conditioning system off if the temperature gauge indicates engine overheating.
- When opening the windows in humid weather, air conditioning may create water droplets inside the vehicle. Since excessive water droplets may cause damage to electrical equipment, air conditioning should only be used with the windows closed.

#### **CAUTION**

The air conditioning system should only be used with the windows and sunroof closed to prevent condensation inside the vehicle that may cause damage to electrical components.

##### Air conditioning system operation tips

- If the vehicle has been parked in direct sunlight during hot weather, open the windows for a short time to let the hot air inside the vehicle escape.
- To help reduce moisture inside of the windows on rainy or humid days, decrease the humidity inside the vehicle by operating the air conditioning system.
- During air conditioning system operation, you may occasionally notice a

slight change in vehicle speed as the air conditioning compressor cycles. This is a normal characteristic of system operation.

- To ensure maximum system performance, the air conditioning system should be run for a few minutes each month.
- When using the air conditioning system, you may notice clear water dripping (or even puddling) on the ground under the passenger side of the vehicle. This is a normal characteristic of system operation.
- Operating the air conditioning system in the recirculated air position provides maximum cooling; however, continual operation in this mode may cause the air inside the vehicle to become stale.
- During cooling operation, you may occasionally notice a misty air flow because of rapid cooling and humid air intake. This is a normal characteristic of system operation.

### Climate control air filter

The climate control air filter installed behind the glove box filters the dust or other pollutants that come into the vehicle from the outside through the heating and air conditioning system.

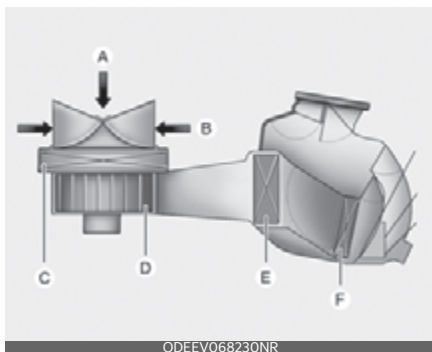

ODEEV068230NR

- A: Outside air
- B: Recirculated air
- C: Climate control air filter
- D: Blower
- E: Evaporator core
- F: Heater core

If dust or other pollutants accumulate in the filter over a period of time, the air flow from the air vents may decrease. This leads to moisture accumulating on the inside of the windshield even when the outside (fresh) air position is selected. If this happens, have the climate control air filter replaced by an authorized Kia dealer.

### \* NOTICE

- Replace the filter according to the Maintenance Schedule. If the vehicle is being driven in severe conditions such as dusty or rough roads, more frequent air conditioner filter inspections and changes are required.
- When the air flow rate suddenly decreases, have the system be inspected by an authorized Kia dealer.

### Air conditioning refrigerant label

Example



OKA4040574N

\* The actual air conditioning refrigerant label in the vehicle may differ from the illustration.

Each symbol and specification on the air conditioning refrigerant label is represented below:

1. Classification of refrigerant
2. Amount of refrigerant
3. Classification of Compressor lubricant
4. Caution
5. Flammable Refrigerant
6. To require Registered Technician to service Air Conditioning system



The refrigerant label is located on the underside of the hood.

### Checking the amount of air conditioner refrigerant and compressor lubricant

When the amount of refrigerant is low, the performance of the air conditioning is reduced. Overfilling also has a negative impact on the air conditioning system.

Therefore, if abnormal operation is found, have the system inspected by an authorized Kia dealer.

### ⚠ WARNING

The oil and refrigerant in your vehicle's air conditioning system is under very high pressure. If proper service procedures are not followed, an explosion may result. To reduce the risk of serious injury or death, the air conditioning system in your vehicle should only be serviced by trained and certified technicians.

### ⚠ CAUTION

It is important that the correct type and amount of oil and refrigerant is used, otherwise damage to the vehicle may occur. To prevent damage, the air conditioning system in your vehicle should only be serviced by trained and certified technicians.

### ⚠ WARNING

#### Vehicles equipped with R-1234yf



Since the refrigerant is mildly flammable and operated at high pressure, the air conditioning system should only be serviced by trained and certified technicians. (Refer to the SAE J2845)

It is important that the correct type and amount of oil and refrigerant are used.

All refrigerants should be reclaimed with proper equipment. Venting refrigerants directly to the atmosphere is harmful to individuals and environment.

Failure to heed these warnings can lead to serious injuries.

## Automatic climate control system

The automatic climate control system uses cooling and heating to help maintain a pleasant environment inside the vehicle.

Type A



ODL3A040301

Type B



ODL3A040337

- |   |                                      |
|---|--------------------------------------|
| 1. Driver's temperature control knob    | 10. Air intake control button        |
| 2. Passenger's temperature control knob | 11. Air conditioning (A/C) button    |
| 3. AUTO (automatic control) button      | 12. Climate control display          |
| 4. OFF button                           | 13. Front glass heater (if equipped) |
| 5. Fan speed control button             |                                      |
| 6. Mode selection button                |                                      |
| 7. Front windshield defroster button    |                                      |
| 8. Rear windshield defroster button     |                                      |
| 9. SYNC button                          |                                      |



**\* NOTICE**

Operating the blower when the ENGINE START/STOP button is in the ON position could cause the battery to discharge. Operate the blower when the engine is running.

**Heating and air conditioning automatically**

1. Press the AUTO button.

The modes, fan speeds, air intake and air-conditioning will be controlled automatically by setting the temperature.



2. Turn the temperature control dial to the desired temperature.



• To turn the automatic operation off, select any button or switch of the following:

- Mode selection button
- Air conditioning button
- Front windshield defroster button (Press the button one more time to deselect the front windshield defroster function. The AUTO sign will illuminate on the information display once again.)
- Fan speed control button

The selected function will be controlled manually while other functions operate automatically.

• For your convenience and to improve the effectiveness of the climate control, use the AUTO button and set the temperature to 72 °F (22 °C).

Level	Indicator	LCD Display	Air flow
High			1~8
Medium			1~6
Low			1~4

**\* NOTICE**

Never place anything over the sensor located on the instrument panel to ensure better control of the heating and cooling system.





ODL3A040338

## Heating and air conditioning manually

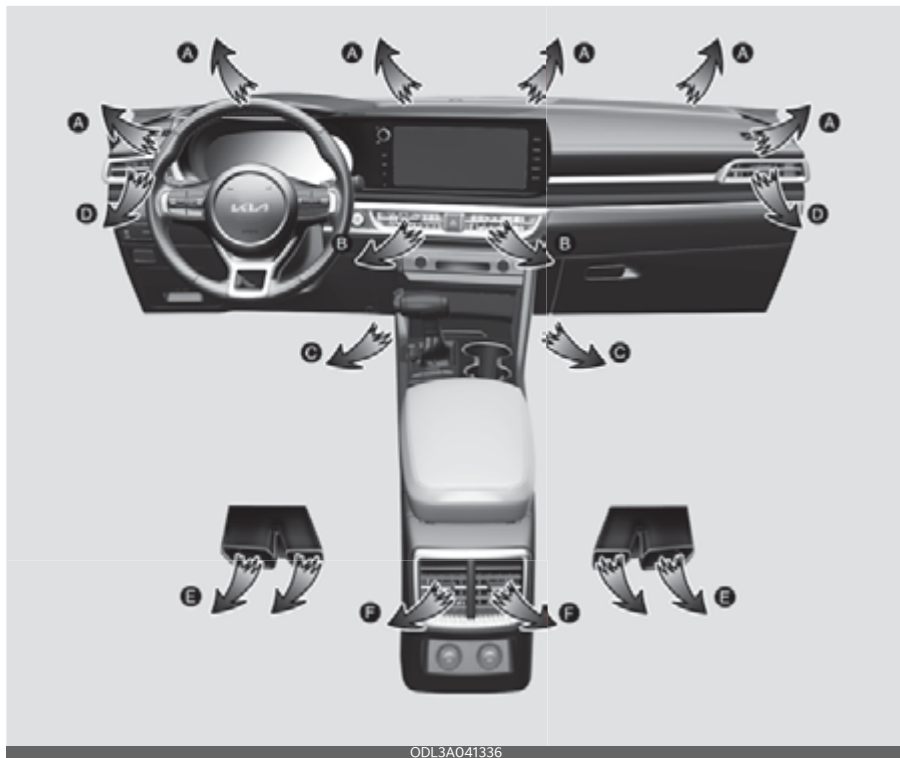
The heating and cooling system can be controlled manually by pressing buttons other than the AUTO button.



In this case, the system works sequentially according to the order of buttons selected.

1. Start the vehicle.
2. Set the mode to the desired position.
  - For improving the effectiveness of heating and cooling;
    - Heating: 
    - Cooling: 
3. Set the temperature control to the desired position.
4. Set the air intake control to the outside (fresh) air position.
5. Set the fan speed control to the desired speed.

If air conditioning is desired, turn the air conditioning system on.

Press the AUTO button in order to convert to fully automatic control of the system.

### Mode selection

The mode selection button controls the direction of the air flow through the ventilation system.



The air flow outlet ports are switched in the following sequence:



#### Face-Level (B, D, F)

Air flow is directed toward the upper body and face. Additionally, each outlet can be controlled to direct the air discharged from the outlet.

#### Bi-Level (B, C, D, E, F)

Air flow is directed towards the face and the floor.

#### Floor-Level (A, C, D, E, F)

Most of the air flow is directed to the floor, with a small amount of the air being directed to the windshield, side window defrosters and side air vents.

#### Floor/Defrost-Level (A, C, D, E, F)

Most of the air flow is directed to the floor and the windshield with a small amount directed to the side window defrosters and side air vents.

#### Defrost-Level (A, D)

Most of the air flow is directed to the windshield with a small amount of air directed to the side window defrosters and side air vents.

### Instrument panel vents

Front

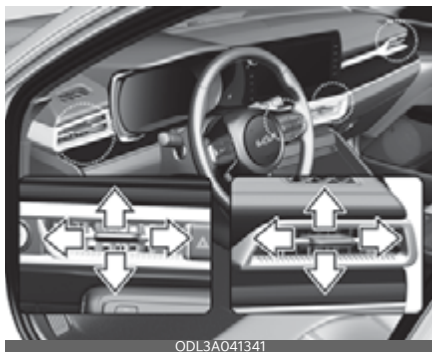

Rear (if equipped)



You can adjust the direction of air delivered from these vents using the vent control lever as shown. If you do not want the air delivered, place the vent control lever to the close  position.

## Temperature control



The temperature will increase to the maximum (HI) by rotating the knob clockwise direction.

The temperature will decrease to the minimum (Lo) by rotating the knob counter clock wise direction.

When rotating the knob, the temperature will increase or decrease by 1 °F (0.5 °C). When set to the lowest temperature setting, the air conditioning will operate continuously.

### \* NOTICE

When starting the vehicle in cold weather using manual temperature control, operate the system in the following method to improve heating.

- Turn off or lower the blower, right after starting the engine.
- Allow the engine to warm up during this time since the air flow from the heater is still cold.
- After a few minutes of engine warm up, turn on or set the fan to a higher level and adjust the temperature setting to hot.

## Adjusting the driver and passenger side temperature equally



1. Press the "SYNC" button to adjust the driver and passenger side temperature equally.

The passenger side temperature will be set to the same temperature as the driver side temperature.

2. Turn the driver side temperature control knob. The driver and passenger side temperature will be adjusted equally.
3. If you rotate the passenger's temperature control knob, the "SYNC" button is off and the passenger side temperature can be operated individually.

## Adjusting the driver and passenger side temperature individually

Press the "SYNC" button again to adjust the driver and passenger side temperature individually. The button indicator will turn off.

## Changing temperature scale

You can switch the temperature mode from Centigrade to Fahrenheit as follows:

- While pressing the OFF button, press the AUTO button for 3 seconds or more.

The display will change from Centigrade to Fahrenheit, or from Fahrenheit to Centigrade. If the battery has been discharged or disconnected, the temperature mode display will reset to Centigrade.

### Controlling air intake

This is used to select the outside (fresh) air position or recirculated air position.



To change the air intake control position:

- Push the desired control button.

### Recirculated air position



With the recirculated air position selected, air from the passenger compartment will be drawn through the heating system and heated

or cooled according to the function selected.

### Outside (fresh) air position

Type A



Type B



With the outside (fresh) air position selected, air enters the vehicle from out-

side and is heated or cooled according to the function selected.

### Controlling fan speed

The fan speed can be set to the desired speed by operating the fan speed control button.

To change the fan speed:

- Press button right for higher speed, or press button left for lower speed.

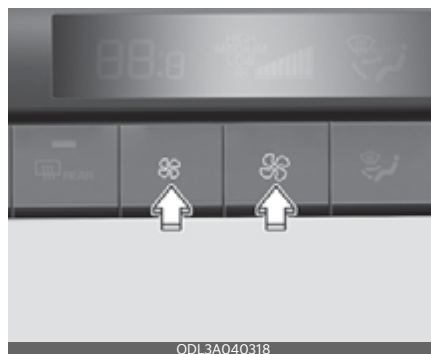

To turn the fan speed control off:

- Press the OFF button.

### Air conditioning (A/C)



- Press the A/C button to turn the air conditioning system on (indicator light will illuminate).
- Press the button again to turn the air conditioning system off.

**⚠ WARNING****Reduced Visibility**

Continued use of the climate control system in the recirculated air position may allow humidity to increase inside the vehicle, which may fog the glass and obscure visibility.

**⚠ WARNING****Recirculated Air**

Continued use of the climate control system in the recirculated air position can cause drowsiness or sleepiness, and loss of vehicle control. Set the air intake control to the outside (fresh) air position as much as possible while driving.

**⚠ WARNING****Sleeping with A/C on**

Do not sleep in a vehicle with the air conditioning or heating on as this may cause serious harm or death due to a drop in the oxygen level and/or body temperature.

**Turning off the front air climate control**

- Press the OFF button to turn off the air climate control system. However, you can still operate the mode and air intake buttons as long as the ENGINE START/STOP button is in the ON position.

**Clean air (if equipped)**

When the ENGINE START/STOP button is in the ON position, the clean air function turns on automatically.

Also, the clean air function turns off automatically, when the ENGINE START/STOP button is in the OFF position.

**Automatic Air Ventilation (if equipped)****Climate control system**

To turn the Auto Dehumidify feature on or off, select Face level (👤) mode and in the pressed state the "A/C" button and press the air intake control button at least five times within three seconds.

When Auto Dehumidify is turned on, the air intake control button indicator will blink 6 times.

When turned off, the indicator will blink 3 times.

**Infotainment system**

Auto Dehumidify can be turned on and off by selecting 'Settings → Vehicle → Climate → Automatic Ventilation → Auto Dehumidify' from the infotainment system screen.

**\* INFORMATION**

The infotainment system may change after software updates. For more information, refer to the user's manual provided in the infotainment system and the quick reference guide.

### Active upon Washer Fluid Use (if equipped)

Recirculation mode automatically activates to reduce any objectionable scent of the washer fluid from entering the cabin when the windshield washer is used.

When it is shifted to the recirculation mode, the unpleasant scent may flow into the vehicle.

However, in cold weather to prevent the windshield from fogging up, the recirculation mode may not be selected.

### Turning Activate upon Washer Fluid Use ON or OFF

#### Climate control system

To turn the Activate upon Washer Fluid Use feature on or off, select Floor level () mode, and then press the air intake control button four times within two seconds while pressing the A/C icon.

When Activate upon Washer Fluid Use ON is turned on, the air intake control button indicator will blink 6 times. When turned off, the indicator will blink 3 times.

#### Infotainment system

Active upon Washer Fluid Use can be turned on and off by selecting 'Settings → Vehicle → Climate → Recirculate Air → Active upon Washer Fluid Use' from the infotainment system screen.

#### \* INFORMATION

The infotainment system may change after software updates. For more information, refer to the user's manual provided in the infotainment system and the quick reference guide.

### Sunroof inside air recirculation (if equipped)

The outside (fresh) air position is automatically selected, when the sunroof is opened. When you select the recirculated air position, the system maintains the recirculated air position for 3 minutes and then automatically converts to the outside (fresh) air position. When the sunroof is closed, the air intake position will return to the original position that was selected.





## Windshield defrosting and defogging

When the windshield is covered with frost or moisture, the front view is blurred, you should remove the frost and moisture.

### ⚠ WARNING

#### Windshield heating

Do not use the  or  position during cooling operation in extremely humid weather. The difference between the temperature of the outside air and the windshield could cause the outer surface of the windshield to fog up, causing loss of visibility. In this case, set the mode selection to the  position and fan speed control to the lower speed.

- For maximum defrosting, set the temperature control to the extreme right/hot position and the fan speed control to the highest speed.
- If warm air to the floor is desired while defrosting or defogging, set the mode to the floor-defrost position.
- Before driving, clear all snow and ice from the windshield, rear window, outside rear view mirrors, and all side windows.
- Clear all snow and ice from the hood and air inlet in the cowl grill to improve heater and defroster efficiency and to reduce the probability of fogging up the inside of the windshield.

### ⚠ CAUTION

Do not place anything on the instrument panel which may cover the air outlets. Otherwise, air flow may be obstructed, preventing the windshield defoggers from defogging.

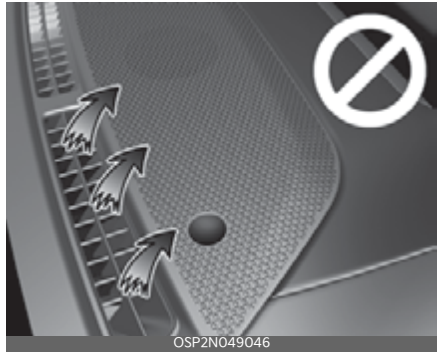

#### Defogging inside windshield with automatic climate control

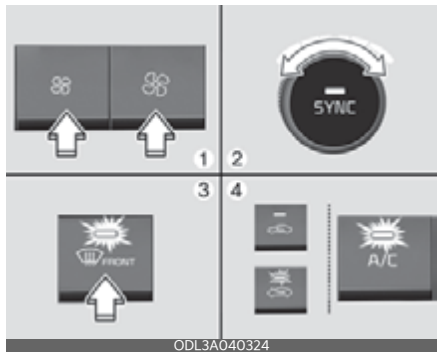

1. Set the fan speed to the desired position.
2. Select desired temperature.
3. Press the defroster button .
4. The outside (fresh) air position will be selected automatically and the air conditioning will turn on according to the detected ambient temperature.

If the air conditioning and outside (fresh) air position are not selected automatically, adjust the corresponding button manually. If the  position is selected, lower fan speed is adjusted to a higher fan speed.

### Defrosting outside windshield with automatic climate control

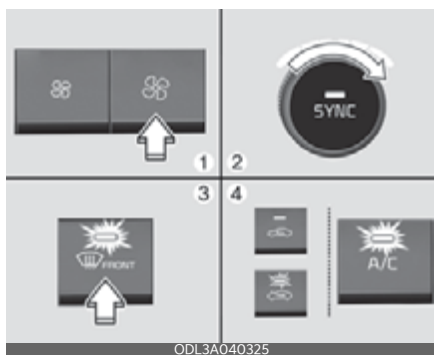

1. Set the fan speed to the highest position.
2. Set the temperature to the extreme hot (HI) position.
3. Press the defroster button .
4. The outside (fresh) air position will be selected automatically and the air conditioning will turn on according to the detected ambient temperature.

### Auto defogging system (only for automatic climate control system) (if equipped)

Auto defogging helps reduce the possibility of fogging up the inside of the windshield by automatically sensing the moisture on inside the windshield.



 The auto defogging system operates when the heater or air conditioning is on.

When the Auto Defogging System operates, the indicator will appear.

If a high amount of humidity is detected in the vehicle, the Auto Defogging System will be enabled.

The following steps will be performed automatically:

1. The A/C button will turn ON.
2. The air intake control will change to Fresh mode under low outside temperature.
3. The mode will be changed to defrost to direct airflow to the windshield.
4. The fan speed will be increased.

To cancel or reset the Auto Defogging System

Press the front windshield defroster button for 3 seconds when the ENGINE START/STOP button is in the ON position.

When the Auto Defogging System is canceled, defrost button indicator will blink 3 times.

When the Auto Defogging System is reset, defrost button indicator will blink 6 times without a signal.

**\* NOTICE**

- When the air conditioning is turned on by Auto defogging system, if you try to turn off the air conditioning, the indicator will blink 3 times and the air conditioning will not be turned off.
- To maintain the effectiveness and efficiency of the Auto Defogging System, do not select Recirculation mode while the system is operating.
- When the Auto Defogging System is operating, the fan speed adjustment knob, the temperature adjustment knob, and the air intake control button are all disabled.

**\* NOTICE**

Do not remove the sensor cover located on the upper end of the driver side windshield glass.  
 Damage to system parts could occur and may not be covered by your vehicle warranty.

**Defroster**

The vehicle is equipped with a defroster for removing frost or fog from the rear window.

**⚠ CAUTION**

**Conductors**

To prevent damage to the conductors bonded to the inside surface of the rear window, never use sharp instruments or window cleaners containing abrasives to clean the window.

If you want to defrost and defog the front windshield, refer to "Windshield defrosting and defogging" on page 4-120.

**Operating rear window defroster**

The defroster heats the window to remove frost, fog and thin ice from the rear window, while the engine is on. If there is heavy accumulation of snow on the rear window, brush it off before operating the rear defroster.



To activate the rear window defroster:

- Press the rear window defroster button located in the heater control panel.  
 The indicator on the rear window defroster button illuminates when the defroster is ON.  
 The rear window defroster automatically turns off after approximately 20 minutes or when the ENGINE START/STOP button is turned off.

To turn off the defroster:

- Press the rear window defroster button again.

**Outside mirror defroster**

If your vehicle is equipped with the outside mirror defrosters, they will operate at the same time you turn on the rear window defroster.

**Front glass heater (if equipped)**

The front glass heater heats the window to remove frost, fog and thin ice from

the interior and exterior of the front window, while the engine is running.





If there is heavy accumulation of snow on the front window, brush it off before operating the front glass heater.

To activate the front glass heater:

- Press the front glass heater button. The indicator on the front glass heater button illuminates when the front glass heater is ON.

The front glass heater automatically turns off after approximately 15 minutes or when the ignition switch is turned off. However, if you press the button again after the heater is turned off automatically after 15 minutes, the heater will stay on only for 5 minutes. To turn off the front glass heater while it is operating, press the front glass heater button again.

### Defogging logic (if equipped)

To reduce the possibility of fogging up the inside of the windshield, the air intake or air conditioning is controlled automatically according to certain conditions such as  or  position.

To cancel automatic defogging logic or return to the automatic defogging logic, do the following.

### Canceling/returning automatic defogging logic

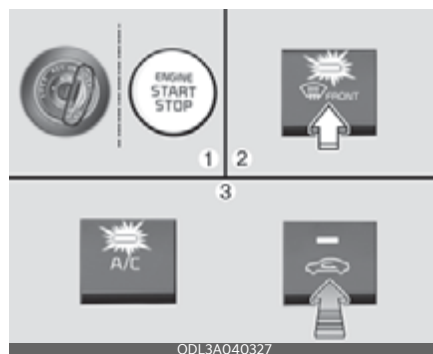

1. Turn the ENGINE START/STOP button to the ON position.
2. Press the defroster button .
3. While pressing the air conditioning (A/C) button, press the air intake control button at least 5 times within 3 seconds.

The recirculation indicator blinks 3 times in 0.5 second of intervals. It indicates that the defogging logic is canceled or returned to the programmed status.

If the battery has been discharged or disconnected, it resets to the defog logic status.

When starting the vehicle in cold weather using manual temperature control, operate the system in the following method to improve heating.

- Turn off or lower the blower, right after starting the engine.
- Allow the engine to warm up during this time since the air flow from the heater is still cold.
- After a few minutes of engine warm up, turn on or set the fan to a higher level and adjust the temperature setting to hot.

## Storage compartment

These compartments can be used to store small items required by the driver or passengers.

- To avoid possible theft, do not leave valuables in the storage compartment.
- Always keep the storage compartment covers closed while driving. Do not attempt to place so many items in the storage compartment that the storage compartment cover cannot close securely.

### **⚠ WARNING**

#### **Flammable materials**

Do not store glasses, gas lighter, portable battery, canned beverage, spray can, propane cylinder, cosmetic tube or other flammable/explosive materials in the vehicle. These items may catch fire and/or explode if the vehicle is exposed to hot temperatures for extended periods.

## Center console storage



To open the center console storage:

- Pull up the lever.

## Glove box



To open the glove box:

- Pull the handle and the glove box will automatically open.

Close the glove box after use.

### **⚠ WARNING**

#### **Glove Box**

To reduce the risk of injury in an accident or sudden stop, always keep the glove box door closed while driving.

### **⚠ CAUTION**

Do not keep food in the glove box for a long time.

### **\* NOTICE**

If the temperature control switch is in the warm or hot position, warm or hot air will flow into the glove box.

## Luggage net holder (if equipped)

To keep items from shifting in the cargo area, you can use the 4 holders located in the cargo area to attach the luggage net.

**⚠ CAUTION**

To prevent damage to the goods or the vehicle, be careful when carrying fragile or bulky objects in the luggage compartment.

**⚠ WARNING**

DO NOT over-stretch the luggage net and ALWAYS keep your face and body out of the luggage net's recoil path. Failure to comply with these instructions may result in severe facial injuries. DO NOT use the luggage net when the strap has visible signs of wear or damage.

**Interior features**

There are various features inside the vehicle for the convenience of the occupants.

**Cup holder**

Front



ODL3049479L

Rear (if equipped)



ODL3A040400

Cups or small beverage cans may be placed in the cup holders.

**⚠ WARNING****Hot liquids**

Do not place uncovered cups with hot liquid in the cup holder while the vehicle is in motion. If the hot liquid spills, you may burn yourself. Such a burn to the

driver could lead to loss of control of the vehicle.

### **⚠ WARNING**

Keep cans or bottles out of direct sun light and do not put them in a vehicle that is heated up. It may explode.

### **⚠ CAUTION**

- Keep your drinks sealed while driving to prevent spilling your drink. If liquid spills, it may get into the vehicle's electrical/electronic system and damage electrical/electronic parts.
- When cleaning spilled liquids, do not use heat to dry the cup holders. This may damage the cup holder.

## **Seat warmer (if equipped)**

The seat warmer is provided to warm the front seats during cold weather.

Front seat



ODL3A030021

Rear seat



ODL3039022

With the ENGINE START/STOP button in the ON position:

- Push either of the levers/switch to warm the driver's seat or the front passenger's seat.

During mild weather or under conditions where the operation of the seat warmer is not needed, keep the levers/switch in the "OFF" position.

The seat warmer defaults to the OFF position whenever the ENGINE START/STOP button is turned on.

### Temperature control (Manual)

- Each time you press the levers/switch, the temperature setting of the seat will change as follows:

- Front seat

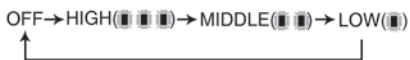

- Rear seat



### Temperature control (Automatic)

The seat warmer starts to automatically control the seat temperature in order to prevent low-temperature burns after being manually turned ON.

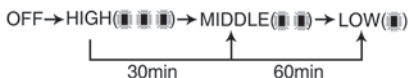

You may manually press the button to increase the seat temperature. However, it soon returns to the automatic mode again.

- When pressing the levers/switch for more than 1.5 seconds with the seat warmer operating, the seat warmer will turn OFF.

### \* NOTICE

With the seat warmer levers/switch in the ON position, the heating system in the seat turns off or on automatically depending on the seat temperature.

### ⚠ CAUTION

- When cleaning the seats, do not use an organic solvent such as paint thinner, benzene, alcohol and gasoline. Doing so may damage the surface of the heater or seats.
- To prevent overheating the seat warmer, do not place anything on the seats that insulates against heat, such as blankets, cushions or seat covers while the seat warmer is in operation.
- Do not place heavy or sharp objects on seats equipped with seat warmers. Damage to the seat warming components could occur.
- Do not change the seat cover. It may damage the seat warmer or air ventilation system.

### ⚠ WARNING

#### Seat warmer burns

Passengers should use extreme caution when using seat warmers due to the possibility of excess heating or burns. The seat warmer may cause burns even at low temperatures, especially if used for long periods of time. In particular, the driver must exercise extreme care for the following types of passengers:

1. Infants, children, elderly or handicapped persons, or hospital outpatients
2. Persons with sensitive skin or those that burn easily
3. Fatigued individuals
4. Intoxicated individuals
5. Individuals taking medication that can cause drowsiness or sleepiness (sleeping pills, cold tablets, etc.)



## Air ventilation seat (if equipped)



ODL3A030023

The temperature setting of the seat changes according to the levers position.

- To ventilate your seat cushion, push the levers.

Each time you push the levers, the air-flow will change as follows:

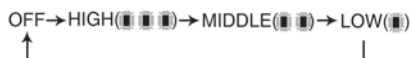

The seat warmer (with air ventilation) defaults to the OFF position whenever the ENGINE START/STOP button is turned on.

### ⚠ CAUTION

#### Seat damage

- When cleaning the seats, do not use an organic solvent such as paint thinner, benzene, alcohol and gasoline. Doing so may damage the air ventilation seat.
- Do not place heavy or sharp objects on the seat. Those things may damage the air ventilation seat.
- Be careful not to spill liquid such as water or beverages on the seat. If you spill some liquid, wipe the seat with a

dry towel. Before using the air ventilation seat, dry the seat completely.

## Sun visor

Use the sun visor to shield direct light through the front or side windows.



ODL3A041401

- To use the sun visor, pull it downward.
- To use the sun visor for the side window, pull it downward, unsnap it from the bracket (1) and swing it to the side (2). You can slide the sun visor if necessary (3).
- To use the vanity mirror, pull down the visor and slide the mirror cover (4).

The ticket holder (5) is provided for holding a tollgate ticket.

### ⚠ WARNING

For your safety, do not block your view when using the sun visor.

### \* NOTICE

Do not put several tickets in the ticket holder at one time. This could cause damage to the ticket holder.

## USB charger

The USB car charger allows drivers to charge their digital devices like smart-phones, and PC tablets.

Front



Center console (if equipped)



Rear (if equipped)



Plug the cable into the USB port, and charging will begin.

The USB car charger is available with either the ACC or the ignition on. We recommend you to connect the USB port and digital devices while the engine is running. See the display screen of the device to check its charging process completion. Your smart phone or tablet PC could be heated up while charging. This is no reason to worry, as it doesn't impact life or functions of the device. For safety, charging can be stopped if the battery heats up to a high temperature that could damage the device. Charging some digital devices may not be available or may require dedicated adapters in order to properly connect to USB charging port. Quick Charge 2.0 is available on the smart phone or the tablet PC equipped with fast charging capabilities. The applicable is as follows: (<https://www.qualcomm.com/documents/quick-charge-device-list>)

The smart phone or tablet PC without fast charging is charged at a regular speed.

Rated output:

- Digital devices with fast charging:
  - 9.0 V, 1.67 A

- Digital devices with normal charging:
  - 5.0 V, 2.1 A

### **⚠ CAUTION**

- Use the USB car charger with the ignition on. Otherwise, Vehicle battery can be discharged.
- Use the official USB cable of the manufacturer of the digital device to be charged.
- Make sure that any foreign object, drinks, or water do not come in contact with the USB car charger. Water or foreign object can damage the USB charger.
- Do not use the device whose current consumption exceeds 2.1 A.
- If the charger is connected incorrectly, it can cause serious damage to the devices. Please note that damages due to incorrect usage are not covered by warranty service.
- Do not connect an electrical device that generates excessive electromagnetic noise to the USB car port. If you do so, noise can be caused or vehicle electronic devices can be interrupted while audio or AV is on.

### **Power outlet**

The power outlet is designed to provide power for mobile telephones or other devices designed to operate with vehicle electrical systems.

Front



The devices should draw less than 10 amps with the vehicle on.

### **\* NOTICE**

- Use the power outlet only when the vehicle is on and remove the accessory plug after use. Using the accessory plug for prolonged periods of time with the vehicle off could cause the battery to discharge.
- Only use 12 V electric accessories which are less than 10 A in electric capacity.
- Adjust the air-conditioner or heater to the lowest operating level when using the power outlet.
- Close the cover when not in use.
- Some electronic devices can cause electronic interference when plugged into a vehicle's power outlet. These devices may cause excessive audio static and malfunctions in other electronic systems or devices used in your vehicle.

- Push the plug in as far as it will go. If good contact is not made, the plug may overheat and the fuse may open.
- Plug in battery equipped electronic devices with reverse current protection. The current from the battery may flow into the vehicle's electrical/electronic system and cause system malfunction.

### **⚠ WARNING**

#### **Electric shock**

Do not put a finger or a foreign object (pen, etc.) into a power outlet and do not touch with a wet hand. You may get an electric shock.

#### **Wireless smart phone charging system (if equipped)**

A wireless smart phone charging system is located in front of the center console.



[A]: Indicator, [B]: Charging pad

Firmly close all doors, and the ENGINE START/STOP button is ON. To start wireless charging, place the smart phone equipped with wireless charging function on the wireless charging pad.

The wireless charging system is designed for one smart phone equipped with Qi only. Please refer to the smart

phone accessory cover or the smart phone manufacturer homepage to check whether your smart phone supports Qi function.

### **⚠ WARNING**

If any metallic object such as coins is located between the wireless charging system and the smart phone, the charging may be disrupted. Also, the metallic object may heat up.

#### **Wireless smart phone charging**

1. Remove any object on the smart phone charging pad including the smart key. If there is any foreign object on the pad other than a smart phone, the wireless charging function may not operate properly.
2. Place the smart phone on the center of the wireless charging pad.
3. The indicator light will change to orange once the wireless charging begins. After the charging is complete, the orange light will change to green.
4. You can choose to turn the wireless charging function to either ON or OFF by selecting the USM on the instrument cluster. (Please refer to "LCD display modes" on page 4-69 for details.)

If the wireless charging does not work, gently move your smart phone around the pad until the charging indicator light turns orange. Depending on the smart phone, the charging indicator light may not turn green even after the charging is complete.

If the wireless charging is not functioning properly, the orange light will blink and flash for ten seconds then turn off. In such cases, remove the smart phone

from the pad and replace it on the pad again, or double check the charging status.

If you leave the smart phone on the charging pad when the vehicle ignition is in OFF, the vehicle will alert you through warning messages and sound (applicable for vehicles with voice guidance function) after the 'Good bye' function on the instrument cluster ends.

For some manufacturers' smart phones, the system may not warn you even though the smart phone is left on the wireless charging unit. This is due to the particular characteristic of the smart phone and not a malfunction of the wireless charging.

### **⚠ WARNING**

#### **Distracted driving**

Driving while distracted can result in a loss of vehicle control that may lead to an accident, severe bodily injury, or death. The driver's primary responsibility is in the safe and legal operation of a vehicle. Any use of handheld devices, other equipment, or vehicle systems that take the driver's eyes, attention, and focus away from the safe operation of a vehicle are not permissible by law. These should never be used during the operation of the vehicle.

### **⚠ CAUTION**

#### **Liquid in Wireless Smart Phone Charger**

To prevent liquid from damaging the wireless smart phone charging system in your vehicle, be sure not to spill liquid over the charging system.

### **⚠ CAUTION**

#### **Metal in Wireless Charging system**

If any metallic object such as a coin is located between the wireless charging system and the smart phone, the charging may be disrupted. Also, the metallic object may heat up and potentially damage the charging system. If there is any metallic object between the smart phone and the charging pad, immediately remove the smart phone. Remove the metallic object after it has cooled down.

### **⚠ CAUTION**

- When the interior temperature of the wireless charging system rises above a set temperature, the wireless charging will cease to function. After the interior temperature drops below the threshold, the wireless charging function will resume.
- The wireless charging may not function properly when there is a heavy accessory cover on the smart phone.
- The wireless charging will stop when using the wireless smart key search function to prevent radio wave disruption.
- The wireless charging will stop when any of the doors are opened (applicable for vehicles equipped with smart keys).
- The wireless charging will stop when the vehicle is turned OFF.
- The wireless charging will stop when the smart phone is not in complete contact with the wireless charging pad.
- Items equipped with magnetic components such as credit card, telephone card, bankbook or any

- transportation ticket may become damaged during wireless charging.
- Place the smart phone on the center of the charge pad for best results. The smart phone may not charge when placed near the rim of the charging pad. When the smart phone does get charged, it may heat up excessively.
  - For smart phones without built-in wireless charging system, an appropriate accessory has to be equipped in order to use the vehicle's wireless charging system.
  - Certain smart phones may display messages on a weak current. This is due to the particular characteristics of that smart phone, and does not imply a malfunction of the wireless charging function.
  - When any smart phone without a wireless charging function or a metallic object is placed on the charging pad, a small noise may sound. This small noise is due to the vehicle discerning compatibility of the object placed on the charging pad. It does not affect your vehicle or the smart phone in any way.
  - The wireless smart phone charging system may not support certain smart phones which are not verified for Qi specification .
  - If your smart phone is off to the side, the charging speed may slow down, and in some cases, your phone may experience higher heat conduction.
  - When charging some smart phones with a self-protection feature, the wireless charging speed may decrease, and the charging may stop.

- A smart phone that supports the wireless charging can only be charged wireless.
- The wireless charging pad has an internal cooling system which can create noise to keep your phone cool while it charges.

---

### This device complies with part 15 of the FCC Rules

Operation is subject to the following two conditions:

1. This device may not cause harmful interference.
2. This device must accept any interference received, including interference that may cause undesired operation.

### Coat hook

A Coat hook is next to the rear grab handle.



\* This actual feature may differ from the illustration.

### CAUTION

#### Hanging clothing

Do not hang heavy clothes, since they may damage the hook.

---

**⚠ WARNING**

Do not hang other objects such as hangers or hard objects except clothes. Also, do not put heavy, sharp or breakable objects in the clothing's pockets. In an accident or when the curtain air bag is inflated, it may cause vehicle damage or body injury.

**Floor mat anchor(s) (if equipped)**

Type A / Type B

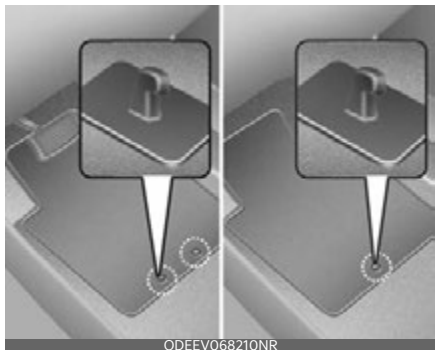

When using a floor mat on the front floor carpet, make sure it attaches to the floor mat anchor(s) in your vehicle. This keeps the floor mat from sliding forward.

**⚠ WARNING****After market floor mat**

- Do not install after market floor mats that are not capable of being securely attached to the vehicle's floor mat anchors.
- Use floor mats not too thick and designed to be properly secured on the floor to avoid the interference with pedals.

Ensure to remove all plastic films on the carpets before installing the mats, especially for a driver's seat, the unsecured mats may cause unintended acceleration/brake. Failure to remove all plastic may result in damage or breaking the floor mat fix rings.

The following must be observed when installing ANY floor mat to the vehicle.

- Ensure that the floor mats are securely attached to the vehicle's floor mat anchor(s) before driving the vehicle.
- Do not use ANY floor mat that cannot be firmly attached to the vehicle's floor mat anchors.
- Do not stack floor mats on top of one another. (e.g., all-weather rubber mat on top of a carpeted floor mat.) Only a single floor mat should be installed in each position.



## Infotainment system

### \* NOTICE

If you install an aftermarket HID head lamp, your vehicle's audio and electronic device may malfunction.

### \* INFORMATION

The infotainment system may change after software updates. For more information, refer to the user's manual provided in the infotainment system and the quick reference guide.

## Antenna



### 1. Shark fin antenna (1)

The sharkfin antenna transmits and receives wireless signals such as AM/FM, Sirius XM, GNSS, etc. \* The signals which antenna can transmit and receive vary by the vehicle option.

### 2. Glass antenna (2, if equipped)

Your vehicle uses a glass antenna to receive AM, FM, and SXM signals.

### \* NOTICE

- To prevent damage to the rear glass antenna, never use sharp instruments or window cleaner containing abrasives to clean the window. Clean the inside surface of the rear glass window with a piece of soft cloth.
- When putting a sticker on the inside surface of the rear window, be careful not to damage to the rear glass antenna.
- Avoid adding metallic coatings such as Ni, Cd, etc.
- These can degrade the receiving AM and FM broadcast signals.
- Tinted rear window may affect the proper functioning of the antenna.

## USB port

You can use the USB port to plug in a USB.





## How vehicle radio works

### FM reception

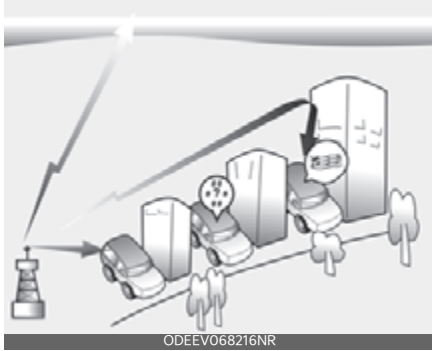

AM and FM radio signals are broadcast from transmitter towers located around your city. They are intercepted by the radio antenna on your vehicle. This signal is then processed by the radio and sent to your vehicle speakers.

However, in some cases the signal coming to your vehicle may not be strong and clear.

This can be due to factors, such as the distance from the radio station, closeness of other strong radio stations or the presence of buildings, bridges or other large obstructions in the area.

### AM reception

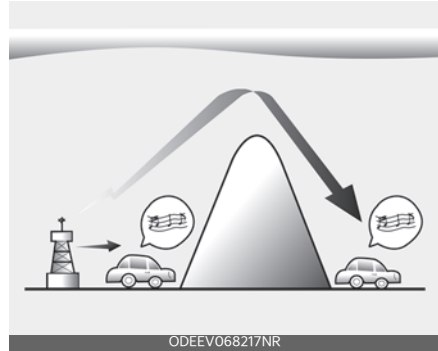

AM broadcasts can be received at greater distances than FM broadcasts. This is because AM radio waves are transmitted at low frequencies. These long distance, low frequency radio waves can follow the curvature of the earth rather than traveling straight. In addition, they curve around obstructions resulting in better signal coverage.

### FM radio station



FM broadcasts are transmitted at high frequencies and do not bend to follow the earth's surface. Because of this, FM broadcasts generally begin to fade within short distances from the station. Also, FM signals are easily affected by buildings, mountains, and obstructions.

This can lead to undesirable or unpleasant listening conditions which might lead you to believe a problem exists with your radio.

The following conditions are normal and do not indicate radio trouble:

- **Fading** - As your vehicle moves away from the radio station, the signal will weaken and sound will begin to fade. When this occurs, we suggest that you select another station with a stronger signal.



- **Flutter/Static** - Weak FM signals or large obstructions between the transmitter and your radio can disturb the signal causing static or fluttering noises to occur. Reducing the treble level may lessen this effect until the disturbance clears.
- **Station Swapping** - As an FM signal weakens, another more powerful signal near the same frequency may begin to play. This is because your radio is designed to lock onto the clearest signal. If this occurs, select another station with a stronger signal.

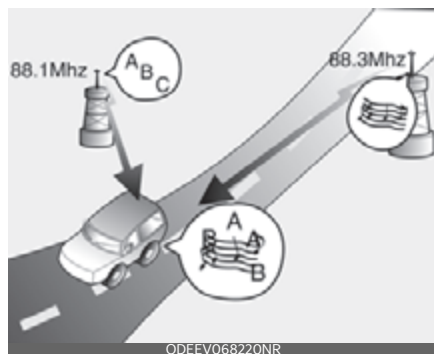

- **Multi-Path Cancellation** - Radio signals being received from several directions can cause distortion or fluttering. This can be caused by a direct and reflected signal from the same station, or by signals from two stations with close frequencies. If this occurs, select another station until the condition has passed.

### Using a cellular phone or a two-way radio

When a cellular phone is used inside the vehicle, noise may be produced from the audio system. This does not mean that something is wrong with the audio equipment. In such a case, try to operate mobile devices as far from the audio equipment as possible.

When using a communication system such as a cellular phone or a radio set inside the vehicle, a separate external antenna must be fitted. When a cellular phone or a radio set is used with only the internal antenna, it may interfere with the vehicle's electrical system and adversely affect the safe operation of the vehicle.

**⚠ WARNING****Cell phone use**

Do not use a cellular phone while driving. Stop at a safe location to use a cellular phone.

---

**⚠ WARNING****Distracted driving**

Driving while distracted can result in a loss of vehicle control that may lead to an accident, severe bodily injury, or death. The driver's primary responsibility is the safe and legal operation of the vehicle. The use of any handheld devices, other equipment, or vehicle systems could take the driver's eyes, attention, and focus away from the safe operation of the vehicle. Using handheld devices or other equipment is not permissible by law and should not be used during operation of the vehicle.

---

**Declaration of Conformity****FCC**

This equipment has been tested and found to comply with the limits for a Class B digital device, pursuant to part 15 of the FCC Rules. These limits are designed to provide reasonable protection against harmful interference in a residential installation.

This equipment generates, uses and can radiate radio frequency energy and, if not installed and used in accordance with the instructions, may cause harmful interference to radio communications. However, there is no guarantee that interference will not occur in a particular installation. If this equipment does cause harmful interference to radio or television reception, which can be determined by turning the equipment off and on, the user is encouraged to try to correct the interference by one or more of the following measures:

- Reorient or relocate the receiving antenna.
- Increase the separation between the equipment and receiver.
- Connect the equipment into an outlet on a circuit different from that to which the receiver is connected.
- Consult the dealer or an experienced radio / TV technician for help.

**\* NOTICE**

Any changes or modifications to this device that is not explicitly approved by the manufacturer could void your authority to operate this equipment.

---

This device complies with part 15 of the FCC Rules. Operation is subject to the following two conditions:

1. This device may not cause harmful interference.
2. This device must accept any interference received, including interference that may cause undesired operation.

This equipment complies with FCC radiation exposure limits set forth for an uncontrolled environment.

This equipment should be installed and operated with minimum 8 in (20 cm) between the radiator and your body.

This transmitter must not be collocated or operating in conjunction with any other antenna or transmitter unless authorized to do so by the FCC.



<b>Be sure the exhaust system does not leak.....</b>	<b>5-3</b>
<b>Before driving .....</b>	<b>5-3</b>
<b>ENGINE START/STOP button.....</b>	<b>5-5</b>
• Illuminated ENGINE START/STOP button.....	5-5
• ENGINE START/STOP button position .....	5-5
• Starting the engine .....	5-7
• Starting the engine with smart key.....	5-7
<b>Automatic transmission .....</b>	<b>5-8</b>
• Automatic transmission operation .....	5-8
• Shift-lock system.....	5-12
• Ignition key interlock system .....	5-12
• Good driving practices .....	5-13
• Moving up a steep grade from a standing start .....	5-14
<b>Dual clutch transmission (DCT) .....</b>	<b>5-14</b>
• Dual clutch transmission operation .....	5-14
• DCT warning messages .....	5-16
• Transmission ranges .....	5-17
• Paddle shifter.....	5-20
• Shift-lock system.....	5-21
• Good driving practices .....	5-21
<b>All wheel drive (AWD).....</b>	<b>5-23</b>
• Using All Wheel Drive (AWD) .....	5-23
• Emergency precautions .....	5-25
<b>Brake system.....</b>	<b>5-27</b>
• Power brakes.....	5-27
• High Performance Brake .....	5-28
• Electronic Parking Brake (EPB).....	5-29
• AUTO HOLD.....	5-33
• Anti-lock Brake System (ABS) .....	5-36
• Electronic Stability Control (ESC) system.....	5-37
• Vehicle Stability Management (VSM) system.....	5-40

# 5 Driving your vehicle

• Hill-start Assist Control (HAC) .....	5-41
• Good braking practices.....	5-41
<b>Vehicle Auto Shut-off system .....</b>	<b>5-43</b>
• Requirements for activation.....	5-43
• Setting Shut-off Time.....	5-43
• Resetting the time .....	5-44
• Canceling the Vehicle Auto Shut-off system.....	5-44
<b>Drive mode integrated control system .....</b>	<b>5-44</b>
• Drive mode .....	5-44
• Smart shift on trip computer .....	5-48
• Vehicle characteristics .....	5-50
<b>Launch Control.....</b>	<b>5-51</b>
• Operation.....	5-51
• Limitations.....	5-52
<b>Economical operation.....</b>	<b>5-53</b>
<b>Special driving conditions .....</b>	<b>5-54</b>
<b>Winter driving .....</b>	<b>5-57</b>
<b>Trailer towing .....</b>	<b>5-61</b>
<b>Vehicle load limit .....</b>	<b>5-62</b>
• Steps For Determining Correct Load Limit - .....	5-63
• Certification label .....	5-64
<b>Vehicle weight.....</b>	<b>5-66</b>
<b>Overloading.....</b>	<b>5-67</b>

## Driving your vehicle

### Be sure the exhaust system does not leak.

The exhaust system should be checked whenever the vehicle is raised to change the oil or for any other purpose.

If you hear a change in the sound of the exhaust or if you drive over something that strikes the underneath side of the vehicle, have the exhaust system checked as soon as possible by an authorized Kia dealer.

#### **WARNING**

##### Engine exhaust

Do not inhale exhaust fumes or leave your engine running in an enclosed area for a prolonged time. Exhaust fumes contain carbon monoxide, a colorless and odorless gas that can cause unconsciousness and death by asphyxiation.

#### **WARNING**

##### Open trunk

Do not drive with the trunk open. Poisonous exhaust gases can enter the passenger compartment. If you must drive with the trunk open proceed as follows:

1. Close all windows.
2. Open side vents.
3. Set the air intake control at "Fresh", the air flow control at "Floor" or "Face", and the fan at the highest speed.

## Before driving

Before getting into the vehicle, you should examine the car and its surroundings. After getting into the vehicle, you should check a number of things before driving.

## Before entering vehicle

- Be sure that all windows, outside mirror(s), and outside lights are clean.
- Check the condition of the tires.
- Check under the vehicle for any sign of leaks.
- Be sure there are no obstacles behind you if you intend to back up.

## Necessary inspections

Fluid levels, such as engine oil, engine coolant, brake fluid, and washer fluid should be checked on a regular basis, at the exact interval depending on the fluid. Further details are provided in "Maintenance" on page 8-4.

#### **WARNING**

##### Distracted driving

Focus on the road while driving. The driver's primary responsibility is in the safe and legal operation of the vehicle. Use of any hand-held devices, other equipment or vehicle systems that distract the driver should not be used during vehicle operation.



## Before starting

- Close and lock all doors.
- Position the seat so that all controls are easily reached.
- Buckle your seat belt.
- Adjust the inside and outside rear view mirrors.
- Be sure that all lights work.
- Check all gauges.
- Check the operation of warning lights when the ENGINE START/STOP button is turned to the ON position.
- Release the parking brake and make sure the brake warning light is not on.

For safe operation, be sure you are familiar with your vehicle and its equipment.

### **⚠ WARNING**

When you intend to park or stop the vehicle with the engine on, be careful not to depress the accelerator pedal for a long period of time. It may overheat the engine or exhaust system and cause fire.

### **⚠ WARNING**

#### **Check surroundings**

Always check the surrounding areas near your vehicle for people, especially children, before putting a vehicle into D (Drive) or R (Reverse).

### **⚠ WARNING**

#### **Loose objects**

Securely store items in your vehicle. When you make a sudden stop or turn the steering wheel rapidly, loose objects may drop on the floor and it could inter-

fere with the operation of the foot pedals, possibly causing an accident.

### **⚠ WARNING**

#### **Driving under the influence**

Do not drive while under the influence of alcohol, drugs, or other impairing substances. Drinking and driving is dangerous. Even a small amount of alcohol will affect your reflexes, perceptions and judgment.

Driving while under the influence of drugs or other impairing substances is as dangerous as or more dangerous than driving drunk.

### **⚠ WARNING**

#### **Proper footwear**

Always wear appropriate shoes when operating your vehicle. Unsuitable shoes (high heels, ski boots, sandals, etc.) may interfere with your ability to use the brake and accelerator pedals.

## ENGINE START/STOP button

### Illuminated ENGINE START/STOP button



The light will go off after about 30 seconds when the door is closed. It will also go off immediately when the theft-alarm system is armed.

### ENGINE START/STOP button position

Your vehicle is equipped with four different ignition positions.

#### OFF

To turn off the engine (START/RUN position) or vehicle power (ON position), press the ENGINE START/STOP button with the shift lever in the P (Park) position. When you press the ENGINE START/STOP button without the shift lever in the P (Park) position, the ENGINE START/STOP button will not change to the OFF position but to the ACC position.

### Vehicles equipped with anti-theft steering column lock

The steering wheel locks when the ENGINE START/STOP button is in the OFF position to protect you against theft.

It locks when the door is opened.

If the steering wheel is not locked properly when you open the driver's door, the warning chime will sound. Try locking the steering wheel again. If the problem is not solved, have the system checked by an authorized Kia dealer.

In addition, if the ENGINE START/STOP button is in the OFF position after the driver's door is opened, the steering wheel will not lock and the warning chime will sound. In such a situation, close the door. Then the steering wheel will lock and the warning chime will stop.

#### \* NOTICE

If the steering wheel doesn't unlock properly, the ENGINE START/STOP button will not work. Press the ENGINE START/STOP button while turning the steering wheel right and left to release the tension.

#### \* NOTICE

You are able to turn off the engine (START/RUN) or vehicle power (ON), only when the vehicle is not in motion.

#### \* NOTICE

In an emergency situation while the vehicle is in motion, you are able to turn the engine off and to the ACC position by pressing the ENGINE START/STOP button for more than 2 seconds or 3 times repeatedly within 3 seconds.

If the vehicle is still moving, to restart the vehicle:

- Press the ENGINE START/STOP button when vehicle speed is 3 mph (5 km/h) or over.

## ACC (Accessory)

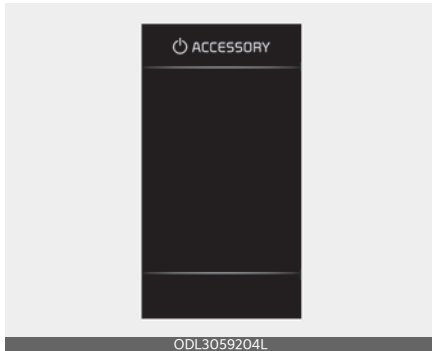

Press the ENGINE START/STOP button while it is in the OFF position without depressing the brake pedal.

The steering wheel unlocks and electrical accessories are operational.

If the ENGINE START/STOP button is in the ACC position for more than 1 hour, the button is turned off automatically to prevent battery discharge.

## ON

Press the ENGINE START/STOP button while it is in the ACC position without depressing the brake pedal.

The warning lights can be checked before the engine is started. Do not leave the ENGINE START/STOP button in the ON position for a long time. The battery may discharge because the engine is not running.

## \* NOTICE

If you leave the ENGINE START/STOP button in the ACC or ON position for a long time, the battery will discharge.

## START/RUN

To start the engine, depress the brake pedal and press the ENGINE START/STOP button with the shift lever in the P (Park) or the N (Neutral) position. For your safety, start the engine with the shift lever in the P (Park) position.

## \* NOTICE

If you press the ENGINE START/STOP button without pressing the brake pedal, the engine will not start and the ENGINE START/STOP button changes as follow: OFF → ACC → ON → OFF or ACC

## ⚠ WARNING

- Never press the ENGINE START/STOP button while the vehicle is in motion. This would result in loss of directional control and braking function, which could cause an accident.
- Before leaving the driver's seat, always make sure the shift lever is engaged in P (Park), set the parking brake fully and shut the engine off. Unexpected and sudden vehicle movement may occur if these precautions are not taken.
- Never reach for the ENGINE START/STOP button or any other controls through the steering wheel while the vehicle is in motion. The presence of your hand or arm in the area could cause loss of vehicle control, an accident and serious bodily injury or death.

- Do not place any movable objects around the driver's seat as they may move while driving, interfere with the driver and lead to an accident.

## Starting the engine

### WARNING

- Do not start the vehicle with the accelerator pedal engaged. The vehicle can move and lead to an accident.
  - Wait until the engine rpm is normal. The vehicle may suddenly move if the brake pedal is released when the rpm is high.
1. Make sure the smart key is located inside the vehicle and close the driver seat. The vehicle may not start if it is not located near the driver seat.
  2. Make sure the parking brake is applied.
  3. Make sure the shift lever is in P (Park). Press the brake pedal fully.  
You can also start the engine when the shift lever is in the N (Neutral) position.
  4. Press the ENGINE START/STOP button.  
Make sure that the accelerator pedal is not pressed.
  5. Do not wait for the engine to warm up while the vehicle remains stationary. Start driving at moderate engine speeds. (Steep accelerating and decelerating should be avoided.)

## Starting the engine with smart key

At the time that the vehicle doors are opened or when the ENGINE START/STOP button is pressed, the vehicle will check for the smart key.

If the smart key is not in the vehicle, the  indicator and a message "Key is not in the vehicle" will appear on the instrument cluster and LCD display. And if all doors are closed, the chime will sound for 5 seconds. The indicator or warning will turn off while the vehicle is moving. Always have the smart key with you.

### WARNING

The engine will start, only when the smart key is in the vehicle. Never allow children or any person who is unfamiliar with the vehicle touch the ENGINE START/STOP button or related parts. Pushing the ENGINE START/STOP button while the smart key is in the vehicle may result in unintended engine activation and/or unintended vehicle movement.

### CAUTION

If the engine stalls while the vehicle is in motion, do not attempt to move the shift lever to the P (Park) position. If the traffic and road conditions permit, you may put the shift lever in the N (Neutral) position while the vehicle is still moving and press the ENGINE START/STOP button in an attempt to restart the engine.

**\* NOTICE**

- If the battery is weak or the smart key does not work correctly, you can start the engine by pressing the ENGINE START/STOP button with the smart key.

When you press the ENGINE START/STOP button directly with the smart key, the smart key should contact the button at a right angle.



ODL3A051002

- When the stop lamp fuse is blown, you cannot start the engine normally. Replace the fuse with a new one. If it is not possible, you can start the engine by pressing the ENGINE START/STOP button for 10 seconds while it is in the ACC position. The engine can start without pressing the brake pedal. But for your safety, always press the brake pedal before starting the engine.

**⚠ CAUTION**

To avoid vehicle damage, do not press the ENGINE START/STOP button for more than 10 seconds, except when the stop lamp fuse is blown.

**Automatic transmission**

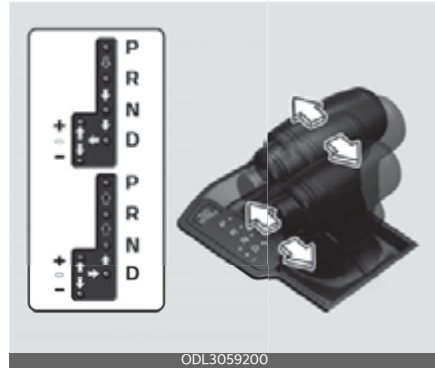

ODL3059200

➡ Press the brake pedal and the lock release button when shifting.

➡ Press the lock release button when shifting.

➡ The shift lever can be shifted freely.

**Automatic transmission operation**

The automatic transmission has 8 forward speeds and one reverse speed. The individual speeds are selected automatically, depending on the position of the shift lever.

**\* NOTICE**

The first few shifts on a new vehicle, if the battery has been disconnected, may be somewhat abrupt. This is a normal condition, and the shifting sequence will adjust after shifts are cycled a few times by the TCM (Transmission Control Module) or PCM (Powertrain Control Module).

For smooth operation, depress the brake pedal when shifting from N (Neutral) to a forward or reverse gear.

**⚠ WARNING****Automatic transmission**

- Always check the surrounding areas near your vehicle for people, especially children, before shifting a vehicle into D (Drive) or R (Reverse).
- Before leaving the driver's seat, always make sure the shift lever is in the P (Park) position; then set the parking brake fully and shut the engine off. Unexpected and sudden vehicle movement can occur if these precautions are not followed in the order identified.
- Do not shift into N (Neutral) while driving. The engine brake may not work causing an accident.
- Do not use the engine brake (shifting from a high gear to lower gear) rapidly on slippery roads.  
The vehicle may slip causing an accident.
- When driving uphill or downhill, always shift to D (Drive) for driving forward or shift to R (Reverse) for driving backwards. Check the gear position indicated on the cluster before driving. Driving in the opposite direction of the selected gear can lead to a dangerous situation by shutting off the engine and affecting the braking performance.

**⚠ CAUTION**

- To avoid damage to your transmission, do not accelerate the engine in R (Reverse) or any forward gear position with the brakes on.
- When stopped on an incline, do not hold the vehicle stationary with engine power. Use the service brake or the parking brake.

- Do not shift from N (Neutral) or P (Park) into D (Drive), or R (Reverse) when the engine is above idle speed.

**Transmission ranges**

The indicator in the instrument cluster displays the shift lever position when the ENGINE START/STOP button is in the ON position.

**P (Park)**

Always come to a complete stop before shifting into P (Park). This position locks the transmission and prevents the front wheels from rotating.

**⚠ WARNING**

- Shifting into P (Park) while the vehicle is in motion will cause the drive wheels to lock which will cause you to lose control of the vehicle.
- Do not use the P (Park) position in place of the parking brake. Always make sure the shift lever is latched in the P (Park) position and set the parking brake fully.
- Never leave a child unattended in a vehicle.

**⚠ CAUTION**

The transmission may be damaged if you shift into P (Park) while the vehicle is in motion.

## R (Reverse)

Use this position to drive the vehicle backward.

### ⚠ CAUTION

Always come to a complete stop before shifting into or out of R (Reverse); you may damage the transmission if you shift into R while the vehicle is in motion, except as explained in "Rocking the vehicle" on page 5-54.

## N (Neutral)

The wheels and transmission are not engaged. The vehicle will roll freely even on the slightest incline unless the parking brake or service brakes are applied.

### ⚠ WARNING

Do not drive with the shift lever in N (Neutral).

The engine brake will not work and can lead to an accident.

## Parking in N (Neutral) gear

Follow below steps when parking and you want the vehicle to move when pushed.

1. After parking your vehicle, step on the brake pedal and move the shift lever to "P" with the ignition button in "ON" or while the engine is running.
2. If the parking brake is applied unlock the parking brake.
  - For EPB (Electronic Parking Brake) equipped vehicles, push the brake pedal with the ignition button in "ON" or while the engine is running to disengage the parking brake. If AUTO HOLD function is used while driving (If "AUTO HOLD" indicator is on in the cluster), press "AUTO HOLD" switch and "AUTO HOLD" function should be turn off.
3. While pressing the brake pedal, turn the ignition button "OFF".
  - For smart key equipped vehicles, the ignition switch can be moved to "OFF" only when the shift lever is in "P".
4. Change the gear shift lever to "N" (Neutral) while pressing the brake pedal and pushing "SHIFT LOCK RELEASE" button or inserting, pressing down a tool (e.g., flathead screwdriver) into the "SHIFT LOCK RELEASE" access hole at the same time. Then, the vehicle will move when external force is applied.

### ⚠ CAUTION

- Always park the vehicle in "P" (Park) for safety and engage the parking brake. If left in "N" (Neutral), the vehicle may move and cause serious damage and injury.
- Before parking in "N" (Neutral) gear, first make sure the parking ground is level and flat. Do not park in "N" gear on any slopes or gradients. If parked and left in "N", the vehicle may move and cause serious damage and injury.
- After the ignition switch or ENGINE START/STOP button has been turned off, the electronic parking brake cannot be disengaged.
- For EPB (Electronic Parking Brake) equipped vehicles with AUTO HOLD function used while driving, if the ignition button has been turned "OFF", the electronic parking brake will be engaged automatically. Therefore, AUTO HOLD function should be

turned off before the ignition button is turned off.

## D (Drive)

This is the normal forward driving position. The transmission will automatically shift through 8 gear sequence, providing the best fuel economy and power.

For extra power when passing another vehicle or climbing grades, depress the accelerator fully, at which time the transmission will automatically downshift to the next lower gear.

### \* NOTICE

Always come to a complete stop before shifting into D (Drive).

## Manual mode



Whether the vehicle is stationary or in motion, manual mode can be selected by pushing the shift lever from the D (Drive) position into the manual gate. To return to D (Drive) range operation, push the shift lever back into the main gate.

Manual mode manages the driving dynamics by automatically adjusting the steering effort, and the engine and transmission control logic for enhanced driver performance.

In manual mode, moving the shift lever backwards and forwards will allow you to select the desired range of gears for the current driving conditions.

- Up (+): Push the lever forward once to shift up one gear.
- Down (-): Pull the lever backwards once to shift down one gear.

### \* NOTICE

- If the driver presses the lever to + (Up) or - (Down) position, the transmission may not make the requested gear change if the next gear is outside of the allowable engine rpm range.
- The driver must execute upshifts in accordance with road conditions, taking care to keep the engine speed below the red zone.
- Only the 8 forward gears can be selected. To reverse or park the vehicle, move the shift lever to the R (Reverse) or P (Park) position as required and only when the vehicle is stopped and not moving.
- Downshifts are made automatically when the vehicle slows down. When the vehicle stops, 1st gear is automatically selected.
- When the engine rpm approaches the red zone shift points are varied to upshift automatically.
- To maintain the required levels of vehicle performance and safety, the system may not execute certain gear shifts when the shift lever is operated.
- When driving on a slippery road, push the shift lever forward into the + (up) position. This causes the transmission to shift into the 2nd gear which is better for smooth driving on a slippery road. Push the shift lever to the -



(down) side to shift back to the 1st gear.

## Shift-lock system

For your safety, the automatic transmission has a shift-lock system which prevents shifting the transmission from P (Park) into R (Reverse) unless the brake pedal is depressed.

To shift the transmission from P (Park) into R (Reverse):

1. Depress and hold the brake pedal.
2. Start the engine or turn the ignition switch to the ON position.
3. Move the shift lever.

If the brake pedal is repeatedly depressed and released with the shift lever in the P (Park) position, a chattering noise near the shift lever may be heard. This is a normal condition.

### **⚠ WARNING**

Always fully depress the brake pedal before and while shifting out of the P (Park) position into another position to avoid inadvertent motion of the vehicle which could injure persons in or around the vehicle.

## Shift-lock override



If the shift lever cannot be moved from the P (Park) position into R (Reverse) position with the brake pedal depressed, continue depressing the brake, then do the following:

1. Place the ENGINE START/STOP button in the OFF position.
2. Apply the parking brake.
3. Carefully remove the cap (1) covering the shift-lock release access hole.
4. Insert a tool (e.g., flathead screwdriver) into the access hole and press down on the tool.
5. Move the shift lever.
6. Remove the tool from the shift-lock override access hole then install the cap.

If the shift lever does not move even after performing this procedure, have the system inspected by an authorized Kia dealer.

## Ignition key interlock system

If your vehicle is equipped with ENGINE START/STOP button, the button will not change to the OFF position unless the shift lever is in the P (Park) position.

## Good driving practices

- Never move the shift lever from P (Park) or N (Neutral) to any other position with the accelerator pedal depressed.
- Never move the shift lever into P (Park) when the vehicle is in motion.
- Be sure the vehicle is completely stopped before you attempt to shift into R (Reverse) or D (Drive).
- Never take the vehicle out of gear and coast down a hill. This may be extremely hazardous. Always leave the vehicle in gear when moving.
- Do not "ride" the brakes. This can cause them to overheat and malfunction. Instead, when you are driving down a long hill, slow down and shift to a lower gear. When you do this, engine braking will help slow down the vehicle.
- Slow down before shifting to a lower gear. Otherwise, the lower gear may not be engaged.
- Always use the parking brake. Do not depend on placing the transmission in P (Park) to keep the vehicle from moving.
- Exercise extreme caution when driving on a slippery surface. Be especially careful when braking, accelerating or shifting gears. On a slippery surface, an abrupt change in vehicle speed can cause the drive wheels to lose traction and the vehicle to go out of control.
- Optimum vehicle performance and economy is obtained by smoothly depressing and releasing the accelerator pedal.

## WARNING

- When driving uphill or downhill, always shift to D (Drive) for driving forward or shift to R (Reverse) for driving backwards, and check the gear position indicated on the cluster before driving. Driving in the opposite direction of the selected gear can lead to a dangerous situation by shutting off the engine and affecting the braking performance.
- Always buckle-up! In a collision, an unbelted occupant is significantly more likely to be seriously injured or killed than a properly belted occupant.
- Avoid high speeds when cornering or turning.
- Do not make quick steering wheel movements, such as sharp lane changes or fast, sharp turns.
- The risk of rollover is greatly increased if you lose control of your vehicle at highway speeds.
- Loss of control often occurs if two or more wheels drop off the roadway and the driver oversteers to reenter the roadway.
- In the event your vehicle leaves the roadway, do not steer sharply. Instead, slow down before pulling back into the travel lanes.
- Never exceed posted speed limits.

## WARNING

If your vehicle becomes stuck in snow, mud, sand, etc., then you may attempt to rock the vehicle free by moving it forward and backward. Do not attempt this procedure if people or objects are anywhere near the vehicle. During the rocking operation the vehicle may suddenly

move forward or backward as it becomes unstuck, causing injury or damage to nearby people or objects.

### Moving up a steep grade from a standing start

To move up a steep grade from a standing start:

- Depress the brake pedal, shift the shift lever to D (Drive). Select the appropriate gear depending on load weight and steepness of the grade, and release the parking brake. Depress the accelerator gradually after releasing the service brakes.

### Dual clutch transmission (DCT) (if equipped)

The dual clutch transmission has 8 forward speeds and one reverse speed.

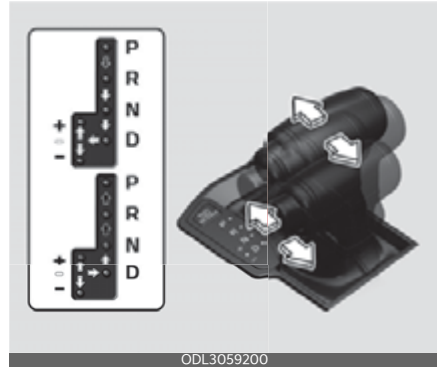

 Depress the brake pedal and the lock release button when shifting.

 Press the lock release button when shifting.

 The shift lever can be shifted freely.

\* To move the shift lever from/to P (Parking) or between R (Reverse) and D (Drive), you must depress the brake pedal for the vehicle to stand still.

### Dual clutch transmission operation

The individual speeds are selected automatically in the D (Drive) position.

#### **WARNING**

To reduce the risk of serious injury or death:

- ALWAYS check the surrounding areas near your vehicle for people, especially children, before shifting a vehicle into D (Drive) or R (Reverse).
- Before leaving the driver's seat, always make sure the shift lever is in the P (Park) position, then set the

parking brake, and place the ENGINE START/STOP button in the OFF position. Unexpected and sudden vehicle movement can occur if these precautions are not followed.

- When using Manual Shift Mode, use caution when shifting from a higher gear to a lower gear on slippery roads. This could cause the tires to slip and may result in an accident.
  - To avoid damage to your transmission, do not try to accelerate with the shift lever in R (Reverse) or any forward gear position with the brake engaged.
  - When stopped on a slope, do not hold the vehicle with accelerator pedal. Engage the service brake or the parking brake.
- 
- The Dual Clutch Transmission gives the driving feel of a manual transmission, yet provides the ease of a fully automatic transmission. Unlike a traditional automatic transmission, the gear shifting can be felt (and heard) on the dual clutch transmission.
    - Think of it as an automatically shifting manual transmission.
    - Shift into Drive range and get fully automatic shifting, similar to a conventional automatic transmission.
  - Dual clutch transmission adopts wet-type dual clutch, which is different from torque converter of automatic transmission, and shows better acceleration performance during driving. But, initial launch might be little bit slower than Automatic Transmission.
  - The wet-type clutch transfers torque and provides a direct driving feeling which may feel different from a conventional automatic transmission with a torque converter. This may be more noticeable when starting from a stop or low vehicle speed.
  - When rapidly accelerating at low vehicle speed, engine could rev at high rpm depending on vehicle drive condition.
  - For smooth launch uphill, press down the accelerator pedal smoothly depending on the current conditions.
  - If you release your foot from the accelerator pedal at low vehicle speed, you may feel strong engine brake, which is similar to manual transmission.
  - When driving downhill, you may use Manual Mode to downshift to a lower gear in order to control your speed without using the brake pedal excessively.
  - When you turn the engine on and off, you may hear clicking sounds as the system goes through a self test. This is a normal sound for the Dual Clutch Transmission.
  - Always come to a complete stop before shifting into D (Drive) or R (Reverse).
  - Do not put the shift lever in N (Neutral) while driving.
  - When driving uphill or downhill, always shift to D (Drive) for driving forward or shift to R (Reverse) for driving backwards. Check the gear position indicated on the cluster before driving. Driving in the opposite direction of the selected gear can lead to a dangerous situation by shutting off the engine and affecting the braking performance.

## \* NOTICE

Due to transmission failure, the vehicle may not move and the position indicator (D, R) will blink on the cluster. In this case, have the system checked by an authorized Kia dealer.

### DCT warning messages

This warning message is displayed when vehicle is driven slowly on a grade and the vehicle detects that the brake pedal is not applied.

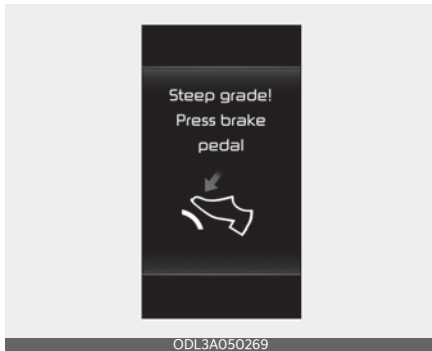

### Steep grade

Driving up hills or on steep grades:

- To hold the vehicle on an incline use the foot brake or the parking brake.
- When in stop-and-go traffic on an incline, keep some distance ahead before moving the vehicle forward. Then hold the vehicle on the incline with the foot brake.
- If the vehicle is held on a hill by applying the accelerator pedal or by creeping with brake pedal disengaged, the clutch and transmission may overheat which can result in damage. At this time, a warning message will appear on the LCD display.

- If the LCD warning is active, the foot brake must be applied.
- Ignoring the warnings can lead to damage to the transmission.

### Transmission high temperature



- Under certain conditions, such as repeated stop-and-go launches on steep grades, sudden take off or acceleration, or other harsh driving conditions, the clutch temperature will increase excessively. Finally, the clutch in transmission could be overheated.
- When the clutch is overheated, the safe protection mode engages and the gear position indicator on the cluster blinks with a chime. At this time, "Transmission temp. is high! Stop safely" warning message will appear on the LCD display and driving may not be smooth.
- If this occurs, pull over to a safe location, stop the vehicle with the engine running, apply the brakes and shift the vehicle to P (Park), and allow the transmission to cool.
- If you ignore this warning, the driving condition may become worse. You may experience abrupt shifts, frequent shifts, or jerkiness. To return to

the normal driving condition, stop the vehicle and apply the foot brake or shift into P (Park).

Then allow the transmission to cool for a few minutes with engine on, before driving off.

- When possible, drive the vehicle smoothly.

## Transmission overheated

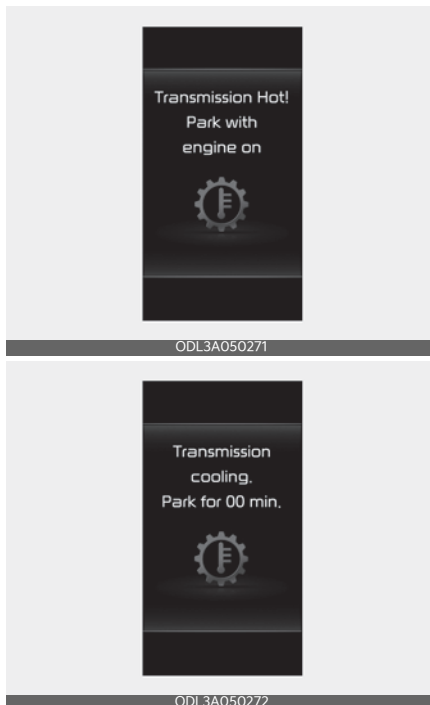

- If the vehicle continues to be driven and the clutch temperatures reach the maximum temperature limit, the "Transmission Hot! Park with engine on" warning will be displayed. When this occurs the clutch is disabled until the clutch cools to normal temperatures.
- The warning will display a time to wait for the transmission to cool.
- If this occurs, pull over to a safe location, stop the vehicle with the engine running, apply the brakes and shift the vehicle to P (Park), and allow the transmission to cool.
- When the message "Trans cooled. Resume driving." appears you can continue to drive your vehicle.
- When possible, drive the vehicle smoothly.

If any of the warning messages in the LCD display continue to blink, for your safety, you should have the system checked by an authorized Kia dealer.

## Transmission ranges

The indicator in the instrument cluster displays the shift lever position when the ignition switch is in the ON position.

## P (Park)

Always come to a complete stop before shifting into P (Park).

To shift from P (Park), you must depress firmly on the brake pedal and make sure your foot is off the accelerator pedal.

The shift lever must be in P (Park) before turning the engine off.

### ⚠ WARNING

- Shifting into P (Park) while the vehicle is in motion may cause you to lose control of the vehicle.
- After the vehicle has stopped, always make sure the shift lever is in P (Park), apply the parking brake, and turn the engine off.
- Do not use the P (Park) position in place of the parking brake.

## R (Reverse)

Use this position to drive the vehicle backward.

### ⚠ CAUTION

Always come to a complete stop before shifting into or out of R (Reverse); you may damage the transmission if you shift into R (Reverse) while the vehicle is in motion.

## N (Neutral)

The wheels and transmission are not engaged.

### ⚠ WARNING

Do not shift into gear unless your foot is firmly on the brake pedal. Shifting into gear when the engine is running at high speed can cause the vehicle to move

very rapidly. You could lose control of the vehicle and hit people or objects.

### ⚠ WARNING

Do not drive with the shift lever in N (Neutral).

The engine brake will not work and may lead to an accident.

## Parking in N (Neutral) gear

Follow the steps below when you are parking and want the vehicle to move when pushed.

1. After parking your vehicle, step on the brake pedal and move the shift lever to "P" with the ignition button in "ON" or while the engine is running.
2. If the parking brake is applied unlock the parking brake.
  - For EPB (Electronic Parking Brake) equipped vehicles, push the brake pedal with the ignition button in "ON" or while the engine is running to disengage the parking brake. If AUTO HOLD function is used while driving (If "AUTO HOLD" indicator is on in the cluster), press "AUTO HOLD" switch and "AUTO HOLD" function should be turned off
3. While pressing the brake pedal, turn the ignition button "OFF".
  - For smart key equipped vehicles, the ignition switch can be moved to "OFF" only when the shift lever is in "P".
4. Change the gear shift lever to "N" (Neutral) while pressing the brake pedal and pushing "SHIFT LOCK RELEASE" button or inserting, pressing down a tool (e.g., flathead screwdriver) into the "SHIFT LOCK

"RELEASE" access hole at the same time. Then the vehicle will move when external force is applied.

### **CAUTION**

- Always park the vehicle in "P" (Park) for safety and engage the parking brake. If left in "N" (Neutral), the vehicle may move and cause serious damage and injury.
- Before parking in "N" (Neutral) gear, first make sure the parking ground is level and flat. Do not park in "N" gear on any slopes or gradients.  
If parked and left in "N", the vehicle may move and cause serious damage and injury.
- After the ignition switch or ENGINE START/STOP button has been turned off, the electronic parking brake cannot be disengaged.
- For EPB (Electronic Parking Brake) equipped vehicles with AUTO HOLD function used while driving, if the ignition button has been turned "OFF", the electronic parking brake will be engaged automatically. Therefore, AUTO HOLD function should be turned off before the ignition button is turned off.

### **D (Drive)**

This is the normal driving position. The transmission will automatically shift through a 8 gear sequence, providing the best fuel economy and power.

For extra power when passing another vehicle or driving uphill depress the accelerator pedal further until you feel the transmission downshift to a lower gear.

To stop the vehicle during driving, please press brake pedal fully to prevent unintended movement.

### **Manual mode**



Whether the vehicle is stationary or in motion, manual mode can be selected by pushing the shift lever from the D (Drive) position into the manual gate. To return to D (Drive) range operation, push the shift lever back into the main gate.

Manual mode manages the driving dynamics by automatically adjusting the steering effort, and the engine and transmission control logic for enhanced driver performance.

In manual mode, moving the shift lever backwards and forwards will allow you to select the desired range of gears for the current driving conditions.

- Up (+): Push the lever forward once to shift up one gear.
- Down (-): Pull the lever backwards once to shift down one gear.

### **\* NOTICE**

- If the driver presses the lever to + (Up) or - (Down) position, the transmission may not make the requested gear change if the next gear is outside of the allowable engine rpm range.



- The driver must execute upshifts in accordance with road conditions, taking care to keep the engine speed below the red zone.
- Only the 8 forward gears can be selected. To reverse or park the vehicle, move the shift lever to the R (Reverse) or P (Park) position as required and only when the vehicle is stopped and not moving.
- Downshifts are made automatically when the vehicle slows down. When the vehicle stops, 1st gear is automatically selected.
- When the engine rpm approaches the red zone shift points are varied to upshift automatically.
- To maintain the required levels of vehicle performance and safety, the system may not execute certain gearshifts when the shift lever is operated.
- When driving on a slippery road, push the shift lever forward into the + (up) position. This causes the transmission to shift into the 2nd gear which is better for smooth driving on a slippery road. Push the shift lever to the - (down) side to shift back to the 1st gear.

## Paddle shifter

The paddle shifter function is available when the shift lever is in the D (Drive) position or the manual mode.



## With the shift lever in the D position

The paddle shifter function will operate when the vehicle speed is more than 6 mph (10 km/h).

Pull the [+] or [-] paddle shifter once to shift up or down one gear and the system changes from automatic mode to manual mode.

To change back to automatic shift mode from manual shift mode, do one of the followings:

- Pull the [-] paddle shifter for more than one second.
- Move the shift lever from D (Drive) to manual gate and return it to D position again.

The manual shift mode also changes back to automatic shift mode in one of the following situations:

- When the accelerator pedal is gently depressed for more than approximately 6 seconds while driving.
- When the vehicle stops.

## With the shift lever in the manual mode

Pull the [+] or [-] paddle shifter once to shift up or down one gear.

### \* NOTICE

If you pull the [+] and [-] paddle shifters at the same time, you cannot shift the gear.

## Shift-lock system

For your safety, the Dual clutch transmission has a shift-lock system which prevents shifting the transmission from P (Park) into R (Reverse) unless the brake pedal is depressed.

To shift the transmission from P (Park) into R (Reverse):

1. Depress and hold the brake pedal.
2. Start the engine or turn the ignition switch to the ON position.
3. Move the shift lever.

If the brake pedal is repeatedly depressed and released with the shift lever in the P (Park) position, a chattering noise & vibration near the shift lever may be heard. This is a normal condition.

### ⚠ WARNING

Always fully depress the brake pedal before and while shifting out of the P (Park) position into another position to avoid inadvertent motion of the vehicle which could injure persons in or around the vehicle.

## Shift-lock override



If the shift lever cannot be moved from the P (Park) position into R (Reverse) position with the brake pedal depressed, continue depressing the brake, and then do the following:

1. Place the ENGINE START/STOP button in the OFF position.
2. Apply the parking brake.
3. Carefully remove the cap covering (1) the shift-lock release access hole.
4. Insert a tool (e.g., flathead screwdriver) into the access hole and press down on the tool.
5. Move the shift lever.
6. Remove the tool from the shift-lock override access hole then install the cap.

If the shift lever does not move even after performing this procedure, have the system inspected by an authorized Kia dealer.

## Good driving practices

- Never move the shift lever from P (Park) or N (Neutral) to any other position with the accelerator pedal depressed.
- Never move the shift lever into P (Park) when the vehicle is in motion.

- Be sure the car is completely stopped before you attempt to shift into R (Reverse) or D (Drive).
- Never take the car out of gear and coast down a hill. This may be extremely hazardous. Always leave the car in gear when moving.
- Do not "ride" the brakes. This can cause them to overheat and malfunction. Instead, when you are driving down a long hill, slow down and shift to a lower gear. When you do this, engine braking will help slow the car.
- Slow down before shifting to a lower gear. Otherwise, the lower gear may not be engaged.
- Always use the parking brake. Do not depend on placing the transmission in P (Park) to keep the car from moving.
- Exercise extreme caution when driving on a slippery surface. Be especially careful when braking, accelerating or shifting gears. On a slippery surface, an abrupt change in vehicle speed can cause the drive wheels to lose traction and the vehicle to go out of control.
- Optimum vehicle performance and economy is obtained by smoothly depressing and releasing the accelerator pedal.
- Always buckle-up! In a collision, an unbelted occupant is significantly more likely to be seriously injured or killed than a properly belted occupant.
- Avoid high speeds when cornering or turning.
- Do not make quick steering wheel movements, such as sharp lane changes or fast, sharp turns.
- The risk of rollover is greatly increased if you lose control of your vehicle at highway speeds.
- Loss of control often occurs if two or more wheels drop off the roadway and the driver oversteers to reenter the roadway.
- In the event your vehicle leaves the roadway, do not steer sharply. Instead, slow down before pulling back into the travel lanes.
- Never exceed posted speed limits.

### WARNING

- When driving uphill or downhill, always shift to D (Drive) for driving forward or shift to R (Reverse) for driving backwards, and check the gear position indicated on the cluster before driving. Driving in the opposite direction of the selected gear can lead to a dangerous situation by shutting off the engine and affecting the braking performance.

### WARNING

If your vehicle becomes stuck in snow, mud, sand, etc., then you may attempt to rock the vehicle free by moving it forward and backward. Do not attempt this procedure if people or objects are anywhere near the vehicle. During the rocking operation the vehicle may suddenly move forward or backward as it becomes unstuck, causing injury or damage to nearby people or objects.

## Moving up a steep grade from a standing start

To move up a steep grade from a standing start, depress the brake pedal:

- Shift the shift lever to D (Drive).  
Select the appropriate gear depending on load weight and steepness of the grade, and release the parking brake. Depress the accelerator gradually after releasing the brake pedal.

## All wheel drive (AWD) (if equipped)

### Using All Wheel Drive (AWD)



The All Wheel Drive (AWD) System delivers engine power to front and rear wheels for maximum traction. AWD is useful when extra traction is required, such as when driving slippery, muddy, wet, or snow-covered roads.

If the system determines there is a need for four wheel drive, the engine's driving power is distributed to all four wheels automatically.

### WARNING

This vehicle is designed primarily for on road use although it can operate effectively off road. However, it was not designed to drive in challenging off-road conditions. Driving in conditions that exceed the vehicle's intended design or the driver's experience level may result in severe injury or death.

### NOTICE

If the AWD warning light () stays on the instrument cluster, your vehicle may have a malfunction with the AWD system. When the AWD warning light () appears, have the vehicle be checked by an authorized Kia dealer as soon as possible.

### WARNING

To reduce the risk of SERIOUS INJURY or DEATH:

- Do not drive in conditions that exceed the vehicle's intended design such as challenging offroad conditions.

- Avoid high speeds when cornering or turning.
- Do not make quick steering wheel movements, such as sharp lane changes or fast, sharp turns.
- The risk of a rollover is greatly increased if you lose control of your vehicle at highway speeds.
- Loss of control often occurs if two or more wheels drop off the roadway and the driver over steers to reenter the roadway.
- In the event your vehicle leaves the roadway, do not steer sharply. Instead, slow down before pulling back into the travel lanes.

#### \* NOTICE

- Do not drive in water if the level is higher than the bottom of the vehicle.
- Check your brake condition once you are out of mud or water. Depress the brake pedal several times as you move slowly until you feel normal braking return.
- Shorten your scheduled maintenance interval if you drive in offroad conditions such as sand, mud or water (see "Maintenance Under Severe Usage Conditions - Turbo Models" on page 8-14.
- Make sure that AWD vehicle is towed by a flatbed tow truck.

## For safe AWD operation

### Before driving

- Make sure all passengers are wearing seat belts.
- Sit upright and closer to the steering wheel than usual. Adjust the steering wheel to a position comfortable for you to drive.

### Driving on snow-covered or icy roads

- Start off slowly by applying the accelerator pedal gently.
- Use snow tires or tire chains.
- Keep sufficient distance between your vehicle and the vehicle in front of you.
- Use engine braking during deceleration.
- Avoid speeding, rapid acceleration, sudden brake applications, and sharp turns to prevent skids.

### Driving in sand or mud

- Maintain slow and constant speed.
- Use tire chains driving in mud if necessary.
- Keep sufficient distance between your vehicle and the vehicle in front of you.
- Reduce vehicle speed and always check the road condition.
- Avoid speeding, rapid acceleration, sudden brake applications, and sharp turns to prevent getting stuck.

#### \* NOTICE

When the vehicle is stuck in snow, sand or mud, place a non-slip material under the drive wheels to provide traction OR slowly spin the wheels in forward and reverse directions which causes a rock-

ing motion that may free the vehicle. Refer to "Rocking the vehicle" on page 5-54 for more details. However, avoid running the engine continuously at high rpm, which could damage the AWD system.

### \* NOTICE

- When using Snow Tires, mount them on all four wheels.
- When using Tire Chains, install them on all four tires. However, if you are in a situation to use only two tire chains, install them on the front tires. In this case, do not drive more than a short distance to prevent damage to the AWD system.
- If tire chains must be used, install the tire chain after reviewing the instructions provided with the tire chains.
  - \* For more information on Snow Tires and Tire Chains, refer to "Winter driving" on page 5-57.

### Driving up or down hills

- Driving uphill
  - Before starting off, check if it is possible to drive uphill.
  - Drive as straight as possible.
- Driving downhill
  - Do not change gear while driving downhill. Select gear before driving downhill.
  - Drive slowly using engine braking while driving downhill.
  - Drive as straight as possible.

### ⚠ WARNING

Exercise extreme caution when driving up or down steep hills. The vehicle's tires could lose traction depending on the grade, terrain and water/ mud conditions.

### Emergency precautions

#### Tires

### ⚠ WARNING

Do not use tires and wheels of a different size and type than the ones originally installed on your vehicle. It can affect the safety and performance of your vehicle, which could lead to increased steering difficulty or rollover causing serious injury.

When replacing the tires, be sure to equip all four tires with the tire and wheel of the same size, type, tread, brand and load-carrying capacity.

In case of emergency such as tire puncture, repair it using the spare tire for temporary use. Afterwards, have the tire be inspected by an authorized Kia dealer.

### ⚠ WARNING



ODL3A051354N

Never start or run the engine while an AWD vehicle is raised on a jack. The vehicle can slip or roll off of a jack causing serious injury or death to you or those nearby.

## Towing

AWD vehicles must be towed with a wheel lift and dollies or flatbed equipment with all the wheels off the ground. For more information, refer to "Towing" on page 7-21.

## Vehicle inspection

- When the vehicle is on a car lift, do not operate the front and rear wheels separately. All four wheels should be operated.
- Never engage the parking brake while running the engine on a car lift. This may damage the AWD system.

## Dynamometer testing

An AWD vehicle must be tested on a special four wheel chassis dynamometer.

An AWD vehicle should not be tested on a FWD roll tester. If a FWD roll tester must be used, perform the following procedure:

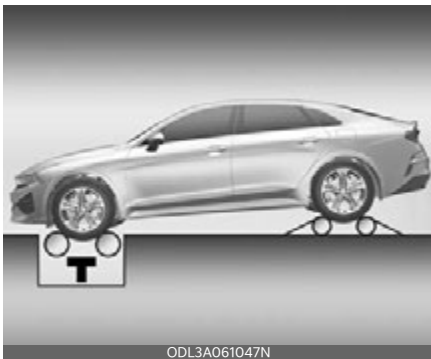

1. Check the tire pressures recommended for your vehicle.
2. Place the front wheels on the roll tester for a speedometer test as shown in the illustration.
3. Release the parking brake.
4. Place the rear wheels on the temporary free roller as shown in the illustration.

## ⚠ WARNING

Keep away from the front of the vehicle while the vehicle is in gear on the dynamometer. The vehicle can jump forward and cause serious injury or death.

## Brake system

Your vehicle has power-assisted brakes, parking brake, and various braking systems for safe driving.

### Power brakes

Your vehicle has power-assisted brakes that adjust automatically through normal usage.

In the event that the power-assisted brakes lose power because of a stalled engine or some other reason, you can still stop your vehicle by applying greater force to the brake pedal than you normally would. The stopping distance, however, will be longer.

When the engine is not running, the reserve brake power is partially depleted each time the brake pedal is applied. Do not pump the brake pedal when the power assist has been interrupted.

Pump the brake pedal only when necessary to maintain steering control on slippery surfaces.

### \* NOTICE

- When stepping on the brake pedal under a certain driving or weather condition you may witness your car make a sound of squealing or some other noises. This is not a brake malfunction but a normal phenomenon.
- When driving on the road to which deicing chemicals are applied, the vehicle may witness noises from the brake or abnormal abrasion of tires because of such deicing chemicals. You should operate brake additionally so that you would be able to remove the deicing chemicals on the brake disk and pad under a safe traffic condition.

### ⚠ CAUTION

#### Brake Pedal

Do not drive with your foot resting on the brake pedal. This will create abnormally high brake temperatures which can cause excessive brake lining and pad wear.

### ⚠ WARNING

#### Steep hill braking

Avoid continuous application of the brakes when descending a long or steep hill by shifting to a lower gear. Continuous brake application will cause the brakes to overheat and could result in a temporary loss of braking performance.

Wet brakes may impair the vehicle's ability to safely slow down; the vehicle may also pull to one side when the brakes are applied. Applying the brakes lightly will indicate whether they have been affected in this way. Always test your brakes in this fashion after driving through deep water. To dry the brakes, apply them lightly while maintaining a safe forward speed until brake performance returns to normal.

#### In the event of brake failure

If service brakes fail to operate while the vehicle is in motion, you can make an emergency stop with the parking brake. The stopping distance, however, will be much greater than normal.

### ⚠ WARNING

#### Parking brake

Avoid applying the parking brake to stop the vehicle while it is moving except in an emergency situation. Applying the parking brake while the vehicle is moving at normal speeds can cause a sud-



den loss of control of the vehicle. If you must use the parking brake to stop the vehicle, use great caution in applying the brake.

### Brake Over Accelerator

In the event the accelerator pedal becomes stuck or entrapped, apply steady and firm pressure to the brake pedal to slow the vehicle and reduce engine power.

If you experience this condition, take the following steps:

1. Apply the brakes and bring your vehicle to a safe stop.
2. Move the transmission to P (Park), switch the engine off and apply the parking brake.
3. Inspect the accelerator pedal for any interference.

If none are found and the condition persists, have your vehicle towed to an authorized Kia dealer and inspected.

### Disc brakes wear indicator

When your brake pads are worn and new pads are required, you will hear a high-pitched warning sound from your front brakes or rear brakes. You may hear this sound come and go or it may occur whenever you press the brake pedal.

Always replace the front or rear brake pads as pairs.

### ⚠ CAUTION

#### Replace brake pads

Do not continue to drive with worn brake pads. Continuing to drive with worn brake pads can damage the braking system and result in costly brake repairs.

### ⚠ WARNING

#### Brake wear

Do not ignore high pitched wear sounds from your brakes. If you ignore this audible warning, you will eventually lose braking performance, which could lead to a serious accident.

### \* NOTICE

Brake dust may accumulate on the wheels, even under normal driving conditions. Some dust is inevitable as the brakes wear and contribute to brake noise.

### High Performance Brake (if equipped)

As this vehicle is equipped with the High Performance Brake (large diameter brakes for enhanced braking performance), noise such as a squeal, squeak or groan is generated while braking. This is normal and the friction may create circle patterns on the disc surface. This is also a normal situation which does not affect braking performance.

### \* NOTICE

- Occasional brake noise is normal. If a continuous grinding or continuous squeal sounds are present, the brake lining may be worn out. Have the vehicle checked by an authorized Kia dealer.
- If the vehicle has continuous vibration or shudder in the steering wheel while braking, have the vehicle checked by an authorized Kia dealer.

**\* NOTICE**

Frequent speeding and braking may deform components and worn the disc brake causing vibration when braking. Prevent brake damage by avoiding excessive braking.

Brake wear, noise, vibration from excessive braking or deformation of the brakes caused by repeatedly braking in high speed, racing on tracks, etc. can be excluded from warranty coverage.



Check the brake warning light by turning the ENGINE START/STOP button ON (do not start the engine). This light will appear when the parking brake is applied with the ENGINE START/STOP button in the START or ON position.

Before driving, be sure the parking brake is fully released and the brake warning light is off.

If the brake warning light remains on after the parking brake is released while engine is running, there may be a malfunction in the brake system. Immediate attention is necessary.

If at all possible, cease driving the vehicle immediately. If that is not possible, use extreme caution while operating the vehicle and only continue to drive the vehicle until you can reach a safe location or repair shop.

**Electronic Parking Brake (EPB)**

After parking the vehicle, apply the Electronic Parking Brake (EPB) to prevent the vehicle from being moved by the external force.

**Applying the parking brake****Applying the parking brake manually**

1. Depress the brake pedal.
2. Pull up the EPB switch.

Make sure the warning light comes on. Also, the EPB is applied automatically if the AUTO HOLD button is on when the vehicle is turned off. In addition, if you pull up the EPB switch after the vehicle is turned off, the EPB will be applied.

**\* NOTICE**

On a steep incline or when pulling a trailer, if the vehicle does not remain at a standstill, do as follows:

1. Apply the EPB.
2. Pull up the EPB switch for more than 3 seconds.

Do not operate the EPB while the vehicle is moving except in an emergency situation.

**\* NOTICE**

A click or electric brake motor whine sound may be heard while operating or releasing the EPB. These conditions are

normal and indicate that the EPB is functioning properly.

### Applying the parking brake automatically

The EPB is applied automatically under following conditions.

- The EPB is overheated
- The driver turns the vehicle OFF while AUTO HOLD is operating
- Requested by other systems

#### \* NOTICE

For Electronic Parking Brake (EPB) equipped vehicles with AUTO HOLD function used while driving, if the ENGINE START/STOP button has been turned OFF, the EPB will be engaged automatically. Therefore, AUTO HOLD function should be turned off before the ENGINE START/STOP button is turned off.

### Emergency braking

If there is a problem with the brake pedal while driving, emergency braking is possible by pulling up and holding the EPB switch. Braking is possible only while you are holding the EPB switch. However, braking distance will be longer than normal.

#### ⚠ WARNING

Do not operate the Electronic Parking Brake (EPB) while the vehicle is moving except in an emergency situation. Applying the EPB while the vehicle is moving at normal speeds can cause a sudden loss of control of the vehicle. If you must

use the EPB to stop the vehicle, use great caution in applying the brake.

#### \* NOTICE

During emergency braking by the EPB, the parking brake warning light will illuminate to indicate that the system is operating.

#### \* NOTICE

If you continuously notice a noise or burning smell when the EPB is used for emergency braking, that may indicate that your EPB is damaged. If that continues, have the system checked by an authorized Kia dealer.

### Releasing the parking brake

#### Releasing the parking brake manually



1. Have the ENGINE START/STOP button in the ON position.
2. Press the brake pedal.
3. Make sure the gear is shifted to P (Park) position.
4. Press the EPB switch.
5. Make sure the brake warning light goes off.

## Releasing the parking brake automatically

The EPB is released automatically under following conditions.

- While the vehicle engine is on and the brake pedal is depressed, the EPB will be released automatically if the gear is shifted from P (Park) or N (Neutral) to R (Reverse) or D (Drive). For your safety, check if the brake warning light is turned off and release the brake pedal.
- Under following conditions, the EPB is released automatically after slowly depressing the accelerator pedal. For your safety, check if the brake warning light is turned off.
  - The vehicle engine is running
  - The driver's seat belt is fastened
  - The driver's door, hood, trunk is closed
  - The gear is in R (Reverse) or D (Drive)

### \* NOTICE

- For the Middle East, EPB is released regardless of seat belt fastening.
- For your safety, you can engage the EPB even though the ENGINE START/STOP button is in the OFF position, but you cannot release it.
- For your safety, depress the brake pedal and release the parking brake manually with the EPB switch when you drive downhill or when backing up the vehicle.

### \* NOTICE

- If the parking brake warning light is still on even though the EPB has been released, have the system checked by

a professional workshop. Visit an authorized Kia dealer.

- Do not drive your vehicle with the EPB applied. It may cause excessive brake pad and brake rotor wear.

## EPB warning messages

### To release EPB, fasten seatbelt, close door, hood, and trunk

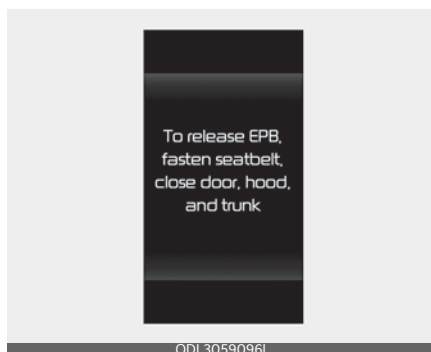

- If you try to drive off while engaging the accelerator pedal with the EPB applied, but the EPB doesn't release automatically, a warning will sound and a message will appear.
- If the driver's seat belt is not fastened and the vehicle hood, driver's door or trunk is opened, a warning will sound and a message will appear.
- If there is a problem with the vehicle, a warning may sound and a message may appear.

If the situation occurs, press the brake pedal and release EPB by pressing the EPB switch.

**⚠ WARNING**

- Whenever leaving the vehicle or parking, always come to a complete stop and continue to depress the brake pedal.

Shift the gear into P (Park), pull the EPB switch, and press the ENGINE START/STOP button to the OFF position. Take the key with you when leaving the vehicle.

Vehicles not fully engaged in P (Park) with the parking brake set are at risk for moving inadvertently and causing injury to yourself or others.

- Never allow a passenger to touch the parking brake. If the parking brake is released unintentionally, serious injury may occur.
- Only release EPB when you are seated inside the vehicle with your foot firmly on the brake pedal.

**\* NOTICE**

- Do not apply the accelerator pedal while the parking brake is engaged. If you depress the accelerator pedal with EPB engaged, a warning will sound and a message will appear. Damage to the parking brake may occur.
- Driving with the parking brake on can overheat the braking system and cause premature wear or damage to brake parts. Make sure EPB is released and the Parking Brake warning light is off before driving.

**\* NOTICE**

- A click or electric brake motor whine sound may be heard while operating or releasing the EPB. These conditions

are normal and indicate that the EPB is functioning properly.

- When leaving your keys with a parking lot attendant or valet, make sure to inform him/her how to operate the EPB.

**Press brake pedal to deactivate AUTO HOLD**

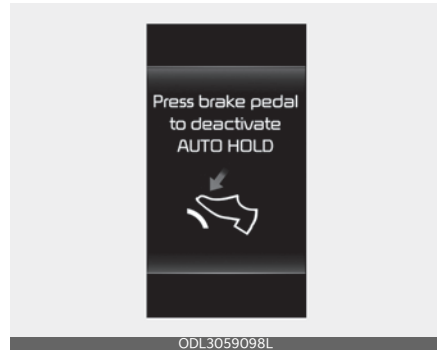

When the conversion from AUTO HOLD to EPB is not working properly a warning will sound and a message will appear.

**Parking brake automatically engaged**

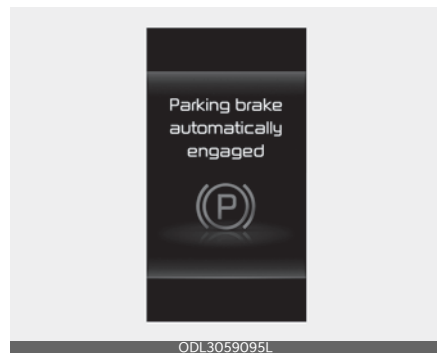

When EPB is applied while AUTO HOLD is activated, a warning will sound and a message will appear.

### EPB malfunction



This warning light illuminates if the ENGINE START/STOP button is changed to the ON position and goes off in approximately 3 seconds if the system is operating normally.

If the EPB malfunction indicator remains on, comes on while driving, or does not come on when the ENGINE START/STOP button is changed to the ON position, this indicates that the EPB may have malfunctioned.

If this occurs, have your vehicle checked by a professional workshop as soon as possible. Visit an authorized Kia dealer.

The EPB malfunction indicator may illuminate when the ESC indicator comes on to indicate that the ESC is not working properly, but it does not indicate a malfunction of the EPB.

#### \* NOTICE

- If the EPB warning light is still on, have the system checked by a professional workshop. Visit an authorized Kia dealer.

- If the parking brake warning light does not illuminate or blinks even though the EPB switch was pulled up, the EPB is not applied.
- If the parking brake warning light blinks when the EPB warning light is on, press the EPB switch, then pull it up. Once more press it back to its original position and pull it back up. If the EPB warning does not go off, have the system checked by a professional workshop. Visit an authorized Kia dealer.

### When the EPB is not released

If the EPB does not release normally, take your vehicle to a professional workshop by loading the vehicle on a flatbed tow truck and have the system checked. Visit an authorized Kia dealer.

### AUTO HOLD

AUTO HOLD is designed to maintain the vehicle in a standstill even though the brake pedal is not pressed after the driver brings the vehicle to a complete stop by pressing the brake pedal.

### Applying AUTO HOLD function

1. Press the brake pedal and start the vehicle.
2. Press the AUTO HOLD button. The white AUTO HOLD indicator will come on indicating the system is in standby.



Before the AUTO HOLD will engage, the driver's door and engine hood must be closed.



When coming to a complete stop by pressing the brake pedal, the AUTO HOLD indicator changes from white to green indicating the AUTO HOLD is engaged. The vehicle will remain at a standstill even if you release the brake pedal.

If EPB is applied, AUTO HOLD will be released.

If you press the accelerator pedal with the shift lever in D (Drive) or Manual mode, the AUTO HOLD will be released automatically and the vehicle will start to move. The indicator changes from green to white indicating the AUTO HOLD is in standby and the EPB is released.

When driving off from AUTO HOLD by pressing the accelerator pedal, always check the surrounding area near your vehicle.

Slowly press the accelerator pedal for a smooth launch.

### Canceling AUTO HOLD function



- To cancel the AUTO HOLD operation, press the AUTO HOLD switch. The AUTO HOLD indicator will go out.
- To cancel the AUTO HOLD operation when the vehicle is at a standstill, press the AUTO HOLD switch while pressing the brake pedal.

### \* NOTICE

- The following are conditions when the AUTO HOLD will not engage (AUTO HOLD light will not turn green and the AUTO HOLD system remains in stand by):
  - The driver's door is opened
  - The engine hood is opened
  - The shift lever is in P (Park) or R (Reverse)
  - The EPB is applied
- For your safety, the AUTO HOLD automatically switches to EPB under any of the following conditions (AUTO

HOLD light remains white and the EPB automatically applies):

- The driver's door is opened.
- The engine hood is opened.
- The vehicle is in a standstill for more than 10 minutes.
- The vehicle is standing on a steep slope.
- The vehicle moved for a few seconds.

In these cases, the brake warning light comes on, the AUTO HOLD indicator changes from green to white, and a warning sounds and a message will appear to inform you that EPB has been automatically engaged. Before driving off again, press foot brake pedal, check the surrounding area near your vehicle and release parking brake manually with the EPB switch.

- If the AUTO HOLD indicator lights up yellow, the AUTO HOLD is not working properly. Take your vehicle to an authorized Kia dealer and have the system checked.

**⚠ WARNING**

To reduce the risk of an accident, do not activate AUTO HOLD while driving downhill, backing up or parking your vehicle.

If there is a malfunction with the driver's door or engine hood open detection system, the AUTO HOLD may not work properly.

Take your vehicle to an authorized Kia dealer and have the system checked.

**\* NOTICE**

A click or electric brake motor whine sound may be heard while operating or releasing the EPB, but these conditions are normal and indicate that the EPB is functioning properly.

**Warning messages**

The AUTO HOLD function will display a warning message with sound under certain conditions.

When the EPB is applied from AUTO HOLD, a warning will sound and a message will appear.

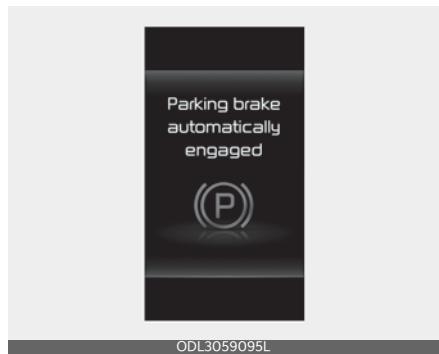

When the conversion from AUTO HOLD to EPB is not working properly a warning will sound and a message will appear.

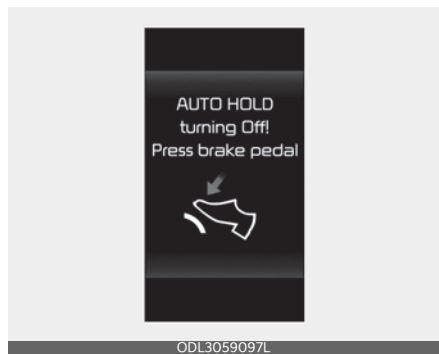



**\* NOTICE**

When this message is displayed, the AUTO HOLD and EPB may not operate. For your safety, press the brake pedal.

If you do not apply the brake pedal when you release the AUTO HOLD by pressing the [AUTO HOLD] switch, a warning will sound and a message will appear.

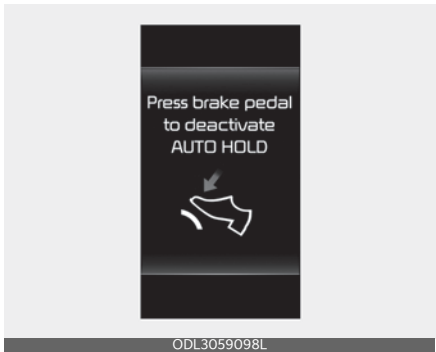

When you press the [AUTO HOLD] switch, if the driver's door and engine hood are not closed, a warning will sound and a message will appear on the LCD display.

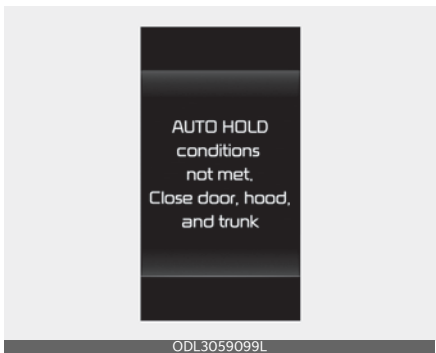

At this moment, press the [AUTO HOLD] button after closing the driver's door and engine hood.

**Anti-lock Brake System (ABS)**

The Anti-lock Brake System (ABS) prevents the wheels from locking. So the vehicle remains stable and can still be steered.

ABS (or ESC) will not prevent accidents due to improper or dangerous driving maneuvers. Even though vehicle control is improved during emergency braking, always maintain a safe distance between you and objects ahead. Vehicle speeds should always be reduced during extreme road conditions. The vehicle should be driven at reduced speeds in the following circumstances:

- When driving on rough, gravel or snow-covered roads
- When driving with tire chains installed
- When driving on roads where the road surface is pitted or has different surface heights.

Driving in these conditions increases the stopping distance for your vehicle.

The ABS continuously senses the speed of the wheels. If the wheels are going to lock, the ABS repeatedly modulates the hydraulic brake pressure to the wheels.

When you apply your brakes under conditions which may lock the wheels, you may hear a "tik-tik" sound from the brakes, or feel a corresponding sensation in the brake pedal. This is normal and it means your ABS is active.

In order to obtain the maximum benefit from your ABS in an emergency situation, do not attempt to modulate your brake pressure and do not try to pump your brakes. Press your brake pedal as hard as possible to allow the ABS to control the force being delivered to the brakes.

### \* NOTICE

A click sound may be heard in the vehicle compartment when the vehicle begins to move after the vehicle is started. These conditions are normal and indicate that the Anti-lock Brake System is functioning properly.

Even with the Anti-lock Brake System, your vehicle still requires sufficient stopping distance. Always maintain a safe distance from the vehicle in front of you. Always slow down when cornering. The Anti-lock Brake System cannot prevent accidents resulting from excessive speeds.

On loose or uneven road surfaces, operation of the Anti-lock Brake System may result in a longer stopping distance than for vehicles equipped with a conventional brake system.

The ABS warning light will stay on for approximately 3 seconds after the ENGINE START/STOP button is ON.



During that time, the ABS will go through self-diagnosis and the light will go off if everything is normal. If the light stays on, you may have a problem with your ABS. Contact an authorized Kia dealer as soon as possible.

When you drive on a road having poor traction, such as an icy road, and have operated your brakes continuously, the ABS will be active continuously and the ABS warning light may appear. Pull your vehicle over to a safe place and stop the vehicle.

Restart the vehicle. If the ABS warning light goes off, then your ABS is normal.

Otherwise, you may have a problem with the ABS. Contact an authorized Kia dealer as soon as possible.

### \* NOTICE

When you jump start your vehicle because of a drained battery, the vehicle may not run as smoothly and the ABS warning light may turn on at the same time. This happens because of low battery voltage. It does not mean your ABS has malfunctioned.

- Do not pump your brakes!
- Have the battery recharged before driving the vehicle.

## Electronic Stability Control (ESC) system

The Electronic Stability Control (ESC) is designed to stabilize the vehicle during cornering maneuvers.



ESC applies the brakes on individual wheels and intervenes with the vehicle management system to stabilize the vehicle.

ESC will not prevent accidents. Excessive speed in turns, abrupt maneuvers and hydroplaning on wet surfaces can still result in serious accidents.

Only a safe and attentive driver can prevent accidents by avoiding maneuvers

that cause the vehicle to lose traction. Even with ESC installed, always follow all the normal precautions for driving - including driving at safe speeds for the conditions.

### **⚠ WARNING**

For maximum protection, always wear your seat belt. No system, no matter how advanced, can compensate for all driver error and/or driving conditions. Always drive responsibly.

The ESC system is an electronic system designed to help the driver maintain vehicle control under adverse conditions. It is not a substitute for safe driving practices. Factors including speed, road conditions and driver steering input can all affect whether ESC will be effective in preventing a loss of control. It is still your responsibility to drive and corner at reasonable speeds and to leave a sufficient margin of safety.

When you apply your brakes under conditions which may lock the wheels, you may hear a "tik-tik" sound from the brakes, or feel a corresponding sensation in the brake pedal. This is normal and it means your ESC is active.

### **\* NOTICE**

A click sound may be heard in the vehicle compartment when the vehicle begins to move after the vehicle is started. These conditions are normal and indicate that the Electronic Stability Control system is functioning properly.

## ESC operation

### ESC ON condition

- When the ENGINE START/STOP button is turned ON, ESC and ESC OFF indicator lights appear for approximately 3 seconds, then ESC is turned on.
- Press the ESC OFF button for at least half a second after turning the vehicle ON to turn ESC off. (ESC OFF indicator will appear). To turn the ESC on, press the ESC OFF button (ESC OFF indicator light will go off).
- When starting the vehicle, you may hear a slight ticking sound. This is the ESC performing an automatic system self-check and does not indicate a problem.

### When operating



When the ESC is in operation, the ESC indicator light blinks.

When the Electronic Stability Control is operating properly, you can feel a slight pulsation in the vehicle. This is only the effect of brake control and indicates nothing unusual.

When moving out of the mud or driving on a slippery road, pressing the accelerator pedal may not cause the vehicle rpm (revolutions per minute) to increase.

### ESC operation off



This car has 2 kinds of ESC off states.

**OFF** If the vehicle stops when ESC is off, ESC remains off. Upon restarting the vehicle, the ESC will automatically turn on again.

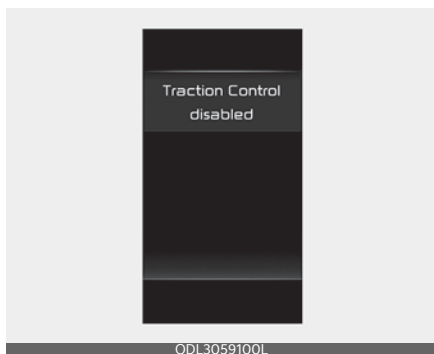

### ESC off state 1

To turn off the traction control function and only operate the brake control function of the ESC, press the ESC OFF button "ESC OFF " for less than 3

seconds and the ESC OFF indicator light "ESC OFF " will appear.



### ESC off state 2

To turn off the traction control function and the brake control function of the ESC, press the ESC OFF button "ESC OFF " for more than 3 seconds. ESC

OFF indicator light "ESC OFF " will appear and ESC OFF warning chime will

sound. At this state, the car stability control function does not operate any more.

### Indicator light

ESC indicator light



ESC OFF indicator light



When ENGINE START/STOP button is turned to ON, the indicator light appears, then goes off if the ESC system is operating normally.

The ESC indicator light blinks whenever ESC is operating or appears when ESC fails to operate.

The ESC OFF indicator light comes on when the ESC is turned off with the button.

### WARNING

#### Electronic Stability Control

Drive carefully even though your vehicle has Electronic Stability Control. It can only assist you in maintaining control under certain circumstances.

### ESC OFF usage

#### When driving

- ESC should be turned on for daily driving whenever possible.
- To turn ESC off while driving, press the ESC OFF button while driving on a flat road surface.

**⚠ WARNING****Operating ESC**

Never press the ESC OFF button while ESC is operating (ESC indicator light blinks).

If ESC is turned off while ESC is operating, the vehicle may slip out of control.

**\* NOTICE**

- When operating the vehicle on a dynamometer, ensure that the ESC is turned off (ESC OFF light appeared). If the ESC is left on, it may prevent the vehicle speed from increasing, and result in false diagnosis.
- Turning the ESC off does not affect ABS or brake system operation.

**Vehicle Stability Management (VSM) system**

The Vehicle Stability Management (VSM) provides further enhancements to vehicle stability and steering responses under the following condition:

- when driving on a slippery road or
- when a change in the coefficient of friction between left and right wheels is detected.

**⚠ WARNING****Tire/wheel size**

When replacing tires and wheels, make sure they are the same size as the original tires and wheels installed. Driving with varying tire or wheel sizes may diminish any supplemental safety benefits of the VSM system.

**VSM operation**

When the VSM is operating properly, you can feel a slight pulsation in the vehicle and/or abnormal steering responses (Motor Driven Power Steering (MDPS)). This is only the effect of brake and MDPS control and indicates nothing unusual.

**The VSM does not operate when:**

- Driving on a sloping road such as a gradient or incline
- Driving in reverse
- ESC OFF indicator light  remains on the instrument cluster
- MDPS indicator light remains on the instrument cluster

**VSM operation off**

If you press the ESC OFF button to turn off the ESC, the VSM will also cancel and the ESC OFF indicator light  appears.

To turn on the VSM, press the button again. The ESC OFF indicator light goes out.

**⚠ WARNING****Vehicle Stability Management**

Drive carefully even though your vehicle has Vehicle Stability Management. It can only assist you in maintaining control of the vehicle under certain circumstances.

## Malfunction indicator

The VSM can be deactivated even if you don't cancel the VSM operation by pressing the ESC OFF button. It indicates that a malfunction has been detected somewhere in the Motor Driven Power Steering system or VSM system. If the ESC indicator light  or MDPS warning

light  remains on, take your vehicle to an authorized Kia dealer and have the system checked.

The VSM is not a substitute for safe driving practices but a supplementary function only. It is the responsibility of the driver to always check the speed and the distance to the vehicle ahead. Always hold the steering wheel firmly while driving.

Your vehicle is designed to activate according to the driver's intention, even with installed VSM. Always follow all the normal precautions for driving at safe speeds for the conditions - including driving in clement weather and on a slippery road.

### WARNING

For maximum protection, always wear your seat belt. No system, no matter how advanced, can compensate for all driver error and/or driving conditions. Always drive responsibly.

## Hill-start Assist Control (HAC)

A vehicle has the tendency to roll back on a steep hill when it starts to go after stopping. The Hill-start Assist Control (HAC) prevents the vehicle from rolling back by applying the brakes automatically for about 2 seconds.

The brakes are released when the accelerator pedal is engaged or after about 2 seconds.

The HAC is activated only for about 2 seconds, so when the vehicle is starting off always engage the accelerator pedal.

### WARNING

#### Maintaining Brake Pressure on Incline

HAC does not replace the need to apply brakes while stopped on an incline.

While stopped, make sure you maintain brake pressure sufficient to prevent your vehicle from rolling backward and causing an accident. Don't release the brake pedal until you are ready to accelerate forward.

## Good braking practices

Good braking practices help keep occupants safe and extend brake life.

- Check to be sure the parking brake is not engaged and the parking brake indicator light is out before driving away.
- Driving through water may get the brakes wet. They can also get wet when the vehicle is washed. Wet brakes can be dangerous! Your vehicle will not stop as quickly if the brakes are wet. Wet brakes may cause the vehicle to pull to one side.

To dry the brakes, apply the brakes lightly until the braking action returns to normal, taking care to keep the vehicle under control at all times. If the braking action does not return to normal, stop as soon as it is safe to do so and call an authorized Kia dealer for assistance.

- Don't coast down hills with the vehicle out of gear. This is extremely hazard-

ous. Keep the vehicle in gear at all times, use the brakes to slow down, then shift to a lower gear so that vehicle braking will help you maintain a safe speed.

- Don't "ride" the brake pedal. Resting your foot on the brake pedal while driving can be dangerous because the brakes might overheat and lose their effectiveness. It also increases the wear of the brake components.
- If a tire goes flat while you are driving, apply the brakes gently and keep the vehicle pointed straight ahead while you slow down. When you are moving slowly enough for it to be safe to do so, pull off the road and stop in a safe place.
- Be cautious when parking on a hill. Firmly engage the parking brake and place the shift lever in P. If your vehicle is facing downhill, turn the front wheels into the curb to help keep the vehicle from rolling.

If your vehicle is facing uphill, turn the front wheels away from the curb to help keep the vehicle from rolling. If there is no curb or if it is required by other conditions to keep the vehicle from rolling, block the wheels.

- Under some conditions your parking brake can freeze in the engaged position. This is most likely to happen when there is an accumulation of snow or ice around or near the rear brakes or if the brakes are wet. If there is a risk that the parking brake may freeze, apply it only temporarily while you put the shift lever in P and block the rear wheels so the vehicle cannot roll. Then release the parking brake.

- Do not hold the vehicle on an incline with the accelerator pedal. This can cause the transmission to overheat. Always use the brake pedal or parking brake.

## Vehicle Auto Shut-off system

The vehicle auto shut-off system is designed to automatically shut off the vehicle after a certain time the driver sets to reduce fuel consumption and energy consumption of the vehicle and to prevent carbon monoxide (CO) poisoning.



### Requirements for activation

This system can be activated when the following all requirements are satisfied.

- The ignition switch is ON.
- The transmission is in the P (Park) position.
- The vehicle stops.
- The vehicle speed is under 2 mph (3 km/h).
- The driver's seat belt is unfastened.
- The door is opened.
- The passenger's seat is not occupied.



### Setting Shut-off Time

The driver can set the shut-off time on the cluster LCD display or the infotainment system screen (if equipped).

The option can be found under the following menu:

1. Press the MODE button (  ) several times on the steering wheel until 'User

Settings' menu appears on the LCD display.

2. Select 'Convenience → Vehicle Auto-Shut Off → 60 min./30 min./Disable' with the MOVE switch (  /  ) and the OK button on the steering wheel.

If your vehicle is equipped with the infotainment system, the option can be found under the following menu:

1. Press 'Settings' button of the Infotainment system.
2. Select 'Vehicle Setting → Convenience → Vehicle Auto-Shut Off → 60min/30min/Off' on the infotainment system screen.

### \* INFORMATION

The infotainment system may change after software updates. For more information, refer to the user's manual provided in the infotainment system and the quick reference guide.

### \* NOTICE

- The default setting will be retained until the timer is reset.
- The timer will revert back to the previous setting at the next startup if the driver selects 'Disable' in the User Settings mode.
- The default setting is 30 minutes.



### Resetting the time

The system can be initialized and restarted under the following conditions:

- When pressing and releasing the brake pedal.
- When the accelerator pedal is depressed.
- When the driver manually resets the timer.
- When the driver manually presses the OK button on the steering wheel.

### Canceling the Vehicle Auto Shut-off system

The system will be canceled automatically when:

- The vehicle speed is over 2 mph (3 km/h).
- The vehicle is shifted to D (Drive), R (Reverse) or N (Neutral).
- The driver's seat belt is fastened.

## Drive mode integrated control system

### Drive mode

The drive mode may be selected according to the driver's preference or road condition.



ODL3059017L

### \* NOTICE

If there is a problem with the instrument cluster, the drive mode will be in NORMAL mode and may not change to SPORT mode.

The mode changes when you toggle the drive mode selection dial.

### Type A

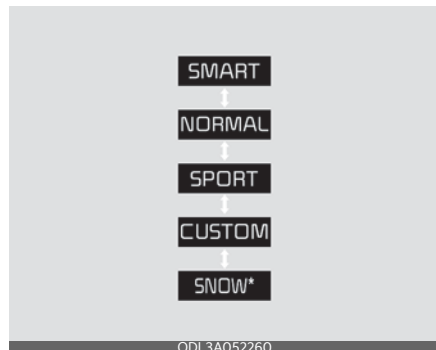

ODL3A052260

Type B

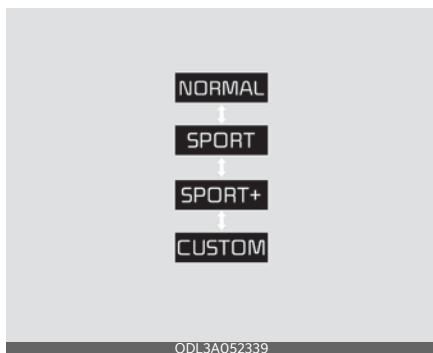

\* : for AWD

When NORMAL mode is selected, it is not displayed on the instrument cluster.

- SMART mode:  
SMART mode automatically adjusts the driving mode in accordance with the driver's driving habits.
- NORMAL mode:  
NORMAL mode provides soft driving and comfortable riding.
- SPORT mode:  
SPORT mode provides sporty but firm riding.
- SPORT+ mode:  
SPORT mode provides sporty but firm riding.
- CUSTOM mode:  
The driver can separately adjust modes of each driving system.
- SNOW mode:  
SNOW mode provides safe driving on the snow road.

The drive mode will change to NORMAL mode when the engine is restarted. However, except when it is in SMART mode. SMART mode will be maintained, as selected when the engine is restarted.

When changing the drive mode setting, the responsiveness of Smart Cruise Control changes. (If equipped)

Drive Mode	SCC Responsiveness
SMART	Normal
NORMAL	Normal
SPORT	Fast

In CUSTOM mode, SCC responsiveness operates according to the mode set in the Engine/Transmission.

(e.g., in CUSTOM mode, the driver selects mode of Engine/Transmission as NORMAL, SCC Responsiveness operates as Normal)

### CUSTOM mode (if equipped)

**CUSTOM** In CUSTOM mode, the driver can select separate modes and combine them on the infotainment system screen.

- Engine/Transmission: NORMAL/SPORT
- Steering wheel: NORMAL/SPORT

For more details, refer to the separately supplied manual with your vehicle.

- When CUSTOM mode is selected by using the drive mode selection dial, the CUSTOM mode indicator will appear.

### \* INFORMATION

The infotainment system may change after software updates. For more information, refer to the user's manual provided in the infotainment system and the quick reference guide.

## SPORT mode

**SPORT** SPORT mode manages the driving dynamics by automatically adjusting the steering effort, the engine and transmission control logic for enhanced driver performance.

- When SPORT mode is selected by using the drive mode selection dial, the SPORT indicator will appear.
- Whenever the engine is restarted, the Drive Mode will revert back to NORMAL mode. If SPORT mode is desired, re-select SPORT mode from the drive mode selection dial.
- When SPORT mode is activated:
  - The engine rpm will tend to remain raised over a certain length of time even after releasing the accelerator
  - Upshifts are delayed when accelerating

### \* NOTICE

In SPORT mode, the fuel efficiency may decrease.

## SPORT+ mode (if equipped)

**SPORT+** SPORT+ mode manages the driving dynamics by automatically adjusting the steering effort, the engine and transmission control logic for enhanced driver performance.

- When SPORT+ mode is selected by using the drive mode selection dial, the SPORT+ indicator will appear.
- Whenever the engine is restarted, the Drive Mode will revert back to NORMAL mode. If SPORT+ mode is desired, re-select SPORT+ mode from the drive mode selection dial.
- When SPORT+ mode is activated:

- The engine rpm will tend to remain raised over a certain length of time even after releasing the accelerator
- Upshifts are delayed when accelerating

### \* NOTICE

In SPORT+ mode, the fuel efficiency may decrease.

## SNOW mode (if equipped)

**SNOW** SNOW mode is used to appropriately distribute the vehicle's traction forces and prevent wheel slippage when driving on snowy or slippery road.

- When SNOW mode is selected by using the drive mode selection dial, the SNOW indicator will appear.
- When SNOW mode is activated:
  - The driving power is distributed to four wheels automatically, increasing the stability of the vehicle.

### \* NOTICE

- Depress the accelerator pedal softly on the snow and the ice.
- Keep the distance from the vehicle in the front.
- Prevent rapid acceleration, deceleration and steering control. Abrupt driving on the snow may cause the accident.

## SMART mode (if equipped)

**SMART** SMART mode selects the proper driving mode among NORMAL, and SPORT by judging the driver's driving habits (i.e., Economic or Aggressive (Sportive)) from the brake pedal depression or the steering wheel operation.

- Toggle the drive mode selection dial to select SMART mode. When SMART mode is selected, the indicator appears on the instrument cluster.
- SMART mode automatically controls the vehicle driving, such as gear shifting patterns and engine torque, in accordance with the driver's driving habits.

### \* NOTICE

- When you mildly drive the vehicle in SMART mode, the driving mode changes to SMART NORMAL mode to improve fuel efficiency. However, the actual fuel efficiency may differ in accordance with your driving situations (i.e., upward/downward slope, vehicle deceleration/acceleration).
- When you dynamically drive the vehicle in SMART mode by abruptly decelerating or sharply turning the driving mode changes to SMART SPORT mode. However, it may adversely affect fuel economy.

## Various driving situations, which you may encounter in SMART mode

- The driving mode automatically changes to NORMAL mode after a certain period of time, when you gently depress the accelerator pedal. (Your driving is categorized to be economic.)
- The driving mode automatically changes from SMART ECO mode to SMART NORMAL mode after a certain period of time when you sharply or repetitively depress the accelerator pedal.
- The driving mode automatically changes to SMART NORMAL mode with the same driving patterns, when the vehicle starts to drive on an upward slope of a certain angle. The driving mode automatically returns to SMART ECO mode, when the vehicle enters a leveled road.
- The driving mode automatically changes to SMART SPORT, when you abruptly accelerate the vehicle or repetitively operate the steering wheel. (Your driving is categorized to be sporty.) In this mode, your vehicle drives in a lower gear for abrupt accelerating/decelerating and increases the engine brake performance.
- You may still sense the engine braking performance, even when you release the accelerator pedal in SMART SPORT mode. It is because your vehicle remains in lower gear over a certain period of time for next acceleration. Thus, it is a normal driving situation, not indicating any malfunction.

- The driving mode automatically changes to SMART SPORT mode only in harsh driving situations. In most of the normal driving situations, the driving mode sets to be either in SMART ECO mode or in SMART NORMAL mode.

**Limitation of SMART mode**

The SMART mode may be limited in following situations. (The OFF indicator appears in those situations.)

- Cruise Control is activated:  
Cruise Control may deactivate the SMART mode when the vehicle is controlled by the set speed of Smart Cruise Control. (SMART mode is not deactivated just by activating Cruise Control.)
- The transmission oil temperature is either extremely low or extremely high:  
The SMART mode can be active in most of the normal driving situations. However, an extremely high/ low transmission oil temperature may temporarily deactivate the SMART mode, because the transmission condition is out of normal operation condition.

**Smart shift on trip computer (if equipped)**

Select the Trip Computer mode on the instrument cluster LCD display and move to the smart shift screen. Then, the driver can see the drive mode selected and the drive mode which is automatically switched by the SMART mode.

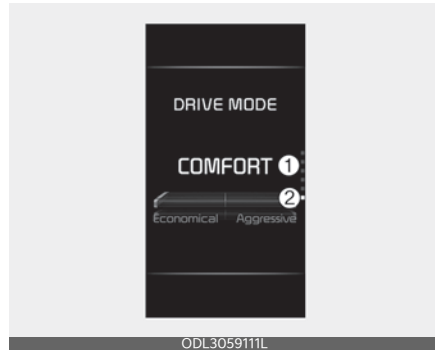

The drive mode selected by the driver (1) and the driving style gauge (2) showing the driver's driving style are displayed on the screen.

## Driver's style gauge in SMART mode



With the standard driving style in the center, the left side of the gauge is 'Econ.' and right side is 'Dynamic' style. When the left side of the driver's style gauge is filled up and after a certain time passes, the SMART ECO mode is activated automatically. When the right side of the gauge is filled up and sporty driving condition is detected, the SMART SPORT mode is activated. To maintain the SMART ECO mode for fuel efficiency, drive with the left side of the gauge filled up.

## Vehicle characteristics (if equipped)

The characteristic of each components varies according to which drive mode is selected by toggling the drive mode selection dial.

DCT	Component	DRIVE MODE		
		NORMAL	SPORT	SPORT+
Engine & Driving	Engine	NORMAL	SPORT	SPORT+
	REV matching	NORMAL	SPORT	SPORT
	Push feel	Off	On (SPORT)	On (SPORT+)
	Launch Control	Off	Off	On (SPORT+)
	LFU* <sup>1</sup> Inhibit Control	Off	On (SPORT)	On (SPORT+)
Chassis	Steering	NORMAL	SPORT	SPORT
	ESC* <sup>2</sup>	NORMAL	NORMAL	SPORT (TCS* <sup>3</sup> OFF)
Sound	ASD* <sup>4</sup>	NORMAL	SPORT	SPORT+

\* 1. Lift Foot up

\* 2. Electronic Stability Control

\* 3. Traction Control System

\* 4. Active Sound Design

## Launch Control (if equipped)

The Launch Control controls the vehicle to reduce wheel spin or slip on a hard acceleration from a standing start.

### Operation

#### Requirements for activation

Launch Control gets ready to be activated, when the following requirements are satisfied.

- All the doors, hood and trunk are closed.
- The driver's seat belt is fastened.
- If the engine temperature is overheated, cool the engine down before using the launch control.
- If the engine temperature is too low, warm up the engine.
- The vehicle is at a complete stop. Then align the steering wheel straight.
- Release the parking brake by pressing the EPB switch and turn off the AUTO HOLD function by releasing the AUTO HOLD button.
- Turn off Cruise Control. (Launch Control function is prohibited during cruise ready condition)

#### **⚠ CAUTION**

- Launch Control is intended for use at a closed race track and not intended for use on public roads. It will not compensate for drivers who are inexperienced or lacking familiarity with the race track.
- The launch performance may be varied by fuel, environment, tire and road condition.
- We recommend you use the function after breaking in your vehicle, and constant use of launch control can put

enormous stress on the vehicle resulting in premature wear of related components.

### Launch Control Ready

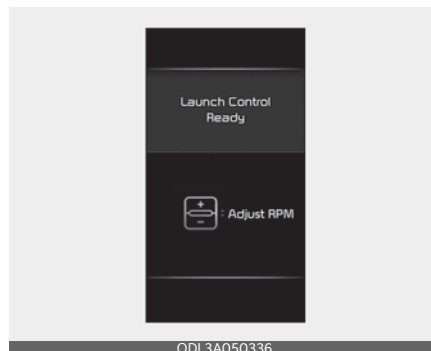

1. Select SPORT+ mode using the drive mode selection switch. (SPORT+ mode indicator will appear on the instrument cluster LCD display.)
2. Turn ESC off by pressing the ESC OFF button for more than 3 seconds. (The ESC OFF indicator will appear on the LCD display.)
3. Shift to the D (Drive) position.
4. Depress the brake pedal firmly with your left foot, and depress the accelerator pedal down fully with your right foot. If the launch control is ready for operation, "Launch Control Ready" message will appear on the LCD display.

5



### Launch Control Active

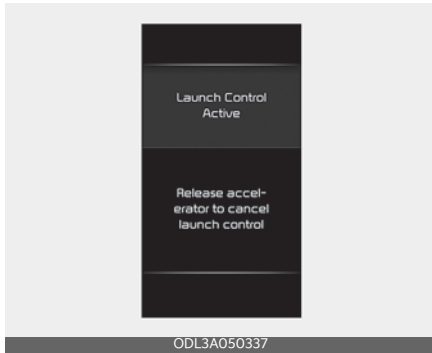

5. Press the accelerator fully and start driving by taking your foot off from the brake pedal within 10 seconds. The Launch Control will operate and "Launch Control Active" message will appear on the LCD display.
6. Release the accelerator pedal to deactivate (end) Launch Control.

#### **⚠ CAUTION**

- If you depress the brake pedal and accelerator pedal simultaneously and take your foot off from the accelerator pedal, the Launch Control will be released.
- If you do not launch within 10 seconds while depressing the brake pedal and accelerator pedal, the Launch Control will be canceled.
- Launch Control is available again after cooling down by driving the vehicle for at least 2 minutes.

### Limitations

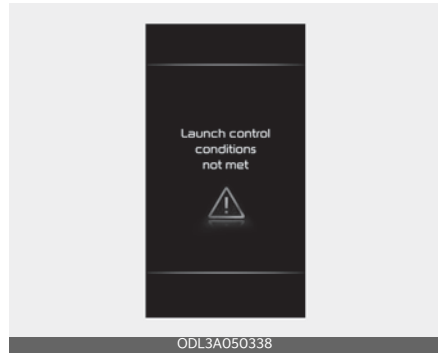

If you use Launch Control when the transmission oil temperature exceeds a certain level, a warning message will be displayed and the Launch Control will not be activated.

In this case, drive your vehicle over 37 mph (60 km/h) to lower the transmission oil temperature to use the Launch Control.

## Economical operation

Your vehicle's fuel economy depends mainly on your style of driving, where you drive and when you drive.

Each of these factors affects how many miles (kilometers) you can get from a gallon (liter) of fuel. To operate your vehicle as economically as possible, use the following driving suggestions to help save money in both fuel and repairs:

- Drive smoothly. Accelerate at a moderate rate. Don't make "jackrabbit" starts or full-throttle shifts and maintain a steady cruising speed. Don't race between stoplights. Try to adjust your speed to the traffic so you don't have to change speeds unnecessarily. Avoid heavy traffic whenever possible.

Always maintain a safe distance from other vehicles so you can avoid unnecessary braking. This also reduces brake wear.

- Drive at a moderate speed. The faster you drive, the more fuel your vehicle uses. Driving at a moderate speed, especially on the highway, is one of the most effective ways to reduce fuel consumption.
- Take care of your tires. Keep them inflated to the recommended pressure. Incorrect inflation, either too much or too little, results in unnecessary tire wear. Check the tire pressures at least once a month.
- Be sure that the wheels are aligned correctly. Improper alignment can result from hitting curbs or driving too fast over irregular surfaces. Poor alignment causes faster tire wear and may also result in other problems as well as greater fuel consumption.

- Keep your car in good condition. For better fuel economy and reduced maintenance costs, maintain your car in accordance with the maintenance schedule in "Scheduled maintenance service" on page 8-9. If you drive your car in severe conditions, more frequent maintenance is required (Refer to "Maintenance Under Severe Usage Conditions - Turbo Models" on page 8-14 for details).
- Travel lightly. Don't carry unnecessary weight in your car. Weight reduces fuel economy.
- Don't let the engine idle longer than necessary. If you are waiting (and not in traffic), turn off your engine and restart only when you're ready to go.
- Don't "lug" or "over-rev" the engine. Lugging is driving too slowly in too high a gear resulting in the engine bucking. If this happens, shift to a lower gear. Over-revving is racing the engine beyond its safe limit. This can be avoided by shifting at the recommended speeds.
- Open windows at high speeds can reduce fuel economy.
- Fuel economy is less in crosswinds and headwinds. To help offset some of this loss, slow down when driving in these conditions.

Keeping a vehicle in good operating condition is important both for economy and safety.

Therefore, have an authorized Kia dealer perform scheduled inspections and maintenance.

**⚠ WARNING****Engine off during motion**

Never turn the engine off to coast down hills or anytime the vehicle is in motion. The power steering and power brakes will not function properly without the engine running. In addition, turning off the ignition while driving could engage the steering wheel lock resulting in loss of vehicle steering. Keep the engine on and downshift to an appropriate gear for engine braking effect.

---

**Special driving conditions**

If driving conditions deteriorate due to poor weather or road conditions, you should pay even more attention than usual to your driving.

**Hazardous driving conditions**

When hazardous driving conditions are encountered such as water, snow, ice, mud, sand, or similar hazards, follow these suggestions:

- Drive cautiously and allow extra distance for braking.
- Avoid sudden braking or steering.
- Do not pump the brake pedal on a vehicle equipped with ABS.
- If stalled in snow, mud, or sand, use the second gear. Accelerate slowly to avoid spinning the drive wheels.
- Use sand, rock salt, tire chains, or other nonslip material under the drive wheels to provide traction when stalled in ice, snow, or mud.

**Rocking the vehicle**

If it is necessary to rock the vehicle to free it from snow, sand, or mud, first turn the steering wheel right and left to clear the area around your front wheels. Then, shift back and forth between R (Reverse) and any forward gear.

Do not race the engine, and spin the wheels as little as possible. If you are still stuck after a few tries, have the vehicle pulled out by a tow vehicle to avoid engine overheating and possible damage to the transmission.

**⚠ WARNING****Sudden Vehicle Movement**

Do not attempt to rock the vehicle if people or objects are nearby. The vehicle may suddenly move forward or backwards as it becomes unstuck.

**⚠ CAUTION****Vehicle rocking**

Prolonged rocking may cause vehicle overheating, transmission damage or failure, and tire damage.

**⚠ CAUTION****Spinning tires**

Do not spin the wheels, especially at speeds more than 35 mph (56 km/h). Spinning the wheels at high speeds when the vehicle is stationary could overheat and damage tires, and the rotating wheels may fly away and injure bystanders.

**\* NOTICE**

The Electronic Stability Control (ESC) should be turned OFF prior to rocking the vehicle.

**Smooth cornering**

Avoid braking or gear changing in corners, especially when roads are wet. Ideally, corners should always be taken under gentle acceleration. If you follow these suggestions, tire wear will be held to a minimum.

**Driving at night**

Because night driving presents more hazards than driving in the daylight, here are some important tips to remember:

- Slow down and keep more distance between you and other vehicles, as it may be more difficult to see at night, especially in areas where there may not be any street lights.
- Adjust your mirrors to reduce the glare from other driver's headlights.
- Keep your headlights clean and properly aimed. (On vehicles not equipped with the automatic headlight aiming feature.) Dirty or improperly aimed headlights will make it much more difficult to see at night.
- Avoid staring directly at the headlights of oncoming vehicles. You could be temporarily blinded, and it will take several seconds for your eyes to readjust to the darkness.

**Driving in the rain**

Rain and wet roads can make driving dangerous, especially if you're not prepared for the slick pavement.

Here are a few things to consider when driving in the rain:

- A heavy rainfall will make it harder to see and will increase the distance needed to stop your vehicle, so slow down.
- Keep your windshield wiping equipment in good shape. Replace your windshield wiper blades when they show signs of streaking or missing areas on the windshield.
- If your tires are not in good condition, making a quick stop on wet pavement can cause a skid and possibly lead to

an accident. Be sure your tires are in good shape.

- Turn on your headlights to make it easier for others to see you.
- Driving too fast through large puddles can affect your brakes. If you must go through puddles, try to drive through them slowly.
- If you believe you may have gotten your brakes wet, apply them lightly while driving until normal braking operation returns.

### Hydroplaning

If the road is wet enough and you are going fast enough, your vehicle may have little or no contact with the road surface and actually ride on the water. The best advice is SLOW DOWN when the road is wet.

The risk of hydroplaning increases as the depth of tire tread decreases, refer to "Tire replacement" on page 8-37.

### Driving in flooded areas

Avoid driving through flooded areas unless you are sure the water is no higher than the bottom of the wheel hub. Drive through any water slowly. Allow adequate stopping distance because brake performance may be affected.

After driving through water, dry the brakes by gently applying them several times while the vehicle is moving slowly.

## Highway driving

### Tires

Adjust the tire inflation pressures to specification. Low tire inflation pressures will result in overheating and possible failure of the tires.

Avoid using worn or damaged tires which may result in reduced traction or tire failure.

Never exceed the maximum tire inflation pressure shown on the tires.

#### **WARNING**

#### **Under/over inflated tires**

Always check the tires for proper inflation before driving. Underinflated or overinflated tires can cause poor handling, loss of vehicle control, and sudden tire failure, leading to accidents, injuries, and even death. For proper tire pressures, refer to "Tires and wheels" on page 8-33.

#### **WARNING**

#### **Tire tread**

Always check the tire tread before driving your vehicle. Worn-out tires can result in loss of vehicle control. Worn-out tires should be replaced as soon as possible. For further information and tread limits, refer to "Tires and wheels" on page 8-33.

## Fuel, engine coolant and engine oil

High speed travel consumes more fuel than urban motoring. Do not forget to check both the engine coolant and engine oil.

## Drive belt

A loose or damaged drive belt may result in overheating of the engine.

## Winter driving

Severe weather conditions in the winter result in greater wear and other problems.

To minimize the problems of winter driving, you should follow these suggestions:

### Snowy or icy conditions

To drive your vehicle in deep snow, it may be necessary to use snow tires or to install tire chains on your tires.

If snow tires are needed, it is necessary to select tires equivalent in size and type of the original equipment tires. Failure to do so may adversely affect the safety and handling of your vehicle. Furthermore, speeding, rapid acceleration, sudden brake applications, and sharp turns are potentially very hazardous practices.

During deceleration, use vehicle braking to the fullest extent. Sudden brake applications on snowy or icy roads may cause skids to occur. You need to keep sufficient distance between the vehicle in operation in front of your vehicle. Also, apply the brake gently. It should be noted that installing tire chains on the tire will provide a greater driving force, but will not prevent side skids.

Tire chains are not legal in all states. Check state laws before fitting tire chains.

### Snow tires

If you mount snow tires on your vehicle, make sure they are radial tires of the same size and load range as the original tires. Mount snow tires on all four wheels to balance your vehicle's handling in all weather conditions. Keep in mind that the traction provided by snow tires on

dry roads may not be as high as your vehicle's original equipment tires. You should drive cautiously even when the roads are clear. Check with the tire dealer for maximum speed recommendations.

Do not install studded tires without first checking local, state and municipal regulations for possible restrictions against their use.

### **⚠ WARNING**

#### **Snow tire size**

Snow tires should be equivalent in size and type to the vehicle's standard tires. Otherwise, the safety and handling of your vehicle may be adversely affected.

#### **Tire chains**



Since the sidewalls on some radial tires are thinner than other types of tires, they may be damaged by mounting certain types of tire chains on them. Therefore, the use of snow tires is recommended instead of tire chains. Do not mount tire chains on vehicles equipped with aluminum wheels; if unavoidable, use a wire type chain. Install the tire chain after reviewing the instructions provided with the tire chains.

Damage to your vehicle caused by improper tire chain use is not covered by your vehicle manufacturer's warranty.

### **\* NOTICE**

The use of tire chains may adversely affect vehicle handling:

- Drive less than 20 mph (30 km/h) or the chain manufacturer's recommended speed limit, whichever is lower.
- Drive carefully and avoid bumps, holes, sharp turns, and other road hazards, which may cause the vehicle to bounce.
- Avoid sharp turns or locked wheel braking.
- For all wheel drive vehicles, the use of snow tires is recommended instead of tire chains; if unavoidable, mount snow chains on the front tires only. In this case, use snow chains with a thickness of less than 0.47 inches (12 mm) and minimize the driving distance in order to prevent damage to the all wheel drive system.

### **\* NOTICE**

- Install tire chains on the front tires. It should be noted that installing tire chains on the tires will provide a greater driving force, but will not prevent side skids.
- Do not install studded tires without first checking local and municipal regulations for possible restrictions against their use.
- Make sure the snow chains are the correct size and type for your tires. Incorrect snow chains can cause damage to the vehicle body and suspension and may not be covered by your vehicle manufacturer warranty. Also,

the snow chain connecting hooks may be damaged from contacting vehicle components causing the snow chains to come loose from the tire. Make sure the snow chains are SAE class "S" certified.

- Always check chain installation for proper mounting after driving approximately 0.3 to 0.6 miles (0.5 to 1 km) to ensure safe mounting. Retighten or remount the chains if they are loose.
- Fabric-type chains must be used on the vehicle with 18/19 inch (235/60R18, 235/55R19) tires

### Chain installation

When installing tire chains, follow the manufacturer's instructions and mount them as tightly as possible. Drive slowly (less than 20 mph (30 km/h)) with chains installed. If you hear the chains contacting the body or chassis, stop and tighten them. If they still make contact, slow down until the noise stops. Remove the tire chains as soon as you begin driving on cleared roads.

When mounting snow chains, park the vehicle on level ground away from traffic. Turn on the vehicle Hazard Warning Flasher and place a triangular emergency warning device behind the vehicle (if available). Always place the vehicle in P (Park), apply the parking brake and turn off the engine before installing snow chains.

#### **WARNING**

##### Mounting chains

When mounting snow chains, park the vehicle on level ground away from traffic. Turn on the vehicle Hazard Warning flashers and place a triangular emergency warning device behind the vehicle

if available. Always place the vehicle in P (Park), apply the parking brake and turn off the engine before installing snow chains.

#### **WARNING**

##### Tire chains

- The use of chains may adversely affect vehicle handling.
- Do not exceed 20 mph (30 km/h) or the chain manufacturer's recommended speed limit, whichever is lower.
- Drive carefully and avoid bumps, holes, sharp turns, and other road hazards, which may cause the vehicle to bounce.
- Avoid sharp turns or locked wheel braking.

#### **CAUTION**

##### Snow chains

- Chains that are the wrong size or improperly installed can damage your vehicle's brake lines, suspension, body and wheels.
- Stop driving and re-tighten the chains any time you hear them hitting the vehicle.

### Use high quality ethylene glycol coolant

Your vehicle is delivered with high quality ethylene glycol coolant in the cooling system. It is the only type of coolant that should be used because it helps prevent corrosion in the cooling system, lubricates the water pump and prevents freezing. Be sure to replace or replenish your coolant refer to "Normal maintenance schedule - Turbo Models" on page



8-11. Before winter, have your coolant tested to assure that its freezing point is sufficient for the temperatures anticipated during the winter.

### **Check battery and cables**

Winter puts additional burdens on the battery system. Visually inspect the battery and cables (refer to "For best battery service" on page 8-31). The level of charge in your battery can be checked by an authorized Kia dealer or a service station.

### **Change to "winter weight" oil if necessary**

In some climates it is recommended that a lower viscosity "winter weight" oil be used during cold weather. Refer to "Recommended lubricants and capacities" on page 9-9 for recommendations. If you aren't sure what weight oil you should use, consult an authorized Kia dealer.

### **Check spark plugs and ignition system**

Inspect your spark plugs as described in "Scheduled maintenance service" on page 8-9 and replace them if necessary. Also, check all ignition wiring and components to be sure they are not cracked, worn or damaged in any way.

### **To keep locks from freezing**

To keep the locks from freezing, squirt an approved de-icer fluid or glycerin into the key opening. If a lock is covered with ice, squirt it with an approved de-icing fluid to remove the ice. If the lock is frozen internally, you may be able to thaw it out by using a heated key. Handle the heated key with care to avoid injury.

### **Use approved window washer anti-freeze in system**

To keep the water in the window washer system from freezing, add an approved window washer anti-freeze solution in accordance with instructions on the container. Window washer anti-freeze is available from an authorized Kia dealer and most auto parts outlets. Do not use vehicle coolant or other types of anti-freeze as these may damage the paint finish.

### **Don't let your parking brake freeze**

Under some conditions your parking brake can freeze in the engaged position. This is most likely to happen when there is an accumulation of snow or ice around or near the rear brakes or if the brakes are wet. If there is a risk the parking brake may freeze, apply it only temporarily while you put the shift lever in P (Park) and block the rear wheels so the vehicle cannot roll. Then release the parking brake.

### **Don't let ice and snow accumulate underneath**

Under some conditions, snow and ice can build up under the fenders and interfere with the steering. In severe winter conditions you should periodically check underneath the vehicle to be sure the movement of the front wheels and the steering components are not obstructed.

**Carry emergency equipment**

Depending on the severity of the weather, you should carry appropriate emergency equipment. Some of the items you may want to carry include tow straps or chains, flashlight, emergency flares, sand, shovel, jumper cables, window scraper, gloves, ground cloth, coveralls, blanket, etc.

**Do not place objects or materials in the engine compartment**

Putting objects or materials in the engine compartment may cause an engine failure or combustion, because they may block the engine cooling. Such damage will not be covered by the manufacturer's warranty.

**Drive your vehicle when water vapor condenses and accumulates inside the exhaust pipes**

When the vehicle is stopped for a long time in winter while the engine is running, water vapor may condense and accumulate inside the exhaust pipes.

Water in the exhaust pipes may cause noise, etc., but it is drained driving at medium to high speed.

**Trailer towing**

We do not recommend using this vehicle for trailer towing.

## Vehicle load limit

The vehicle load limit is displayed on the tire and loading information label on the driver's door.

## Tire and loading information label

The label located on the driver's door sill gives the original tire size, cold tire pressures recommended for your vehicle, the number of people that can be in your vehicle and vehicle capacity weight.

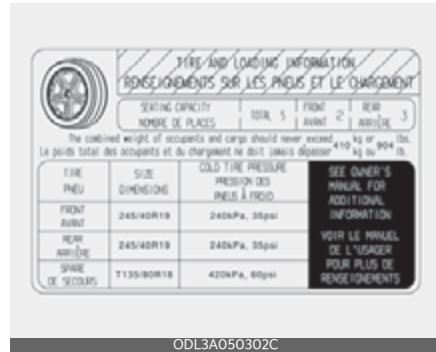

## Vehicle capacity weight:

904 lbs. (410 kg)

Vehicle capacity weight is the maximum combined weight of occupants and cargo. If your vehicle is equipped with a trailer, the combined weight includes the tongue load.

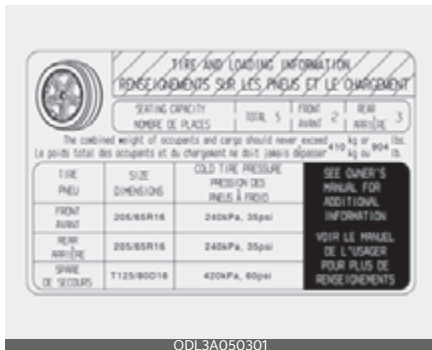

## Seating capacity:

Total: 5 persons (Front seat: 2 persons, Rear seat: 3 persons)

Seating capacity is the maximum number of occupants including a driver, your vehicle may carry.

However, the seating capacity may be reduced based upon the weight of all of the occupants, and the weight of the cargo being carried or towed.

Do not overload the vehicle as there is a limit to the total weight, or load limit including occupants and cargo, the vehicle can carry.



**Towing capacity:**

**We do not recommend using this vehicle for trailer towing.**

**Cargo capacity:**

The cargo capacity of your vehicle will increase or decrease depending on the weight and the number of occupants.

**Steps For Determining Correct Load Limit -**

1. Locate the statement "The combined weight of occupants and cargo should never exceed XXX kg or XXX lbs." on your vehicle's placard.
2. Determine the combined weight of the driver and passengers that will be riding in your vehicle.
3. Subtract the combined weight of the driver and passengers from XXX kg or XXX lbs.
4. The resulting figure equals the available amount of cargo and luggage load capacity. For example, if the "XXX" amount equals 1400 lbs. and there will be five 150 lbs. passengers in your vehicle, the amount of available cargo and luggage load capacity is 650 lbs. (1400-750 (5x150) = 650 lbs.)
5. Determine the combined weight of luggage and cargo being loaded on the vehicle.

That weight may not safely exceed the available cargo and luggage load capacity calculated in Step 4.

6. If your vehicle will be towing a trailer, load from your trailer will be transferred to your vehicle. Consult this manual to determine how this reduces the available cargo and luggage load capacity of your vehicle.

**⚠ WARNING****Loose cargo**

Do not travel with unsecured blunt objects in the passenger compartment of your vehicle (e.g., suit cases or unsecured child seats). These items may strike occupant during a sudden stop or crash.

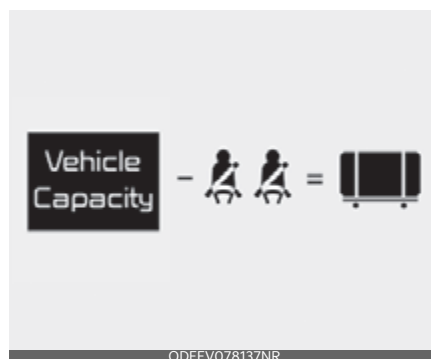
**Example 1**

Example 3

Item	Description	Total
A	Vehicle Capacity Weight	849 lbs. (385 kg)
B	Subtract Occupant Weight 150 lbs. (68 kg)×2	300 lbs. (136 kg)
C	Available Cargo and Luggage weight	549 lbs. (249 kg)

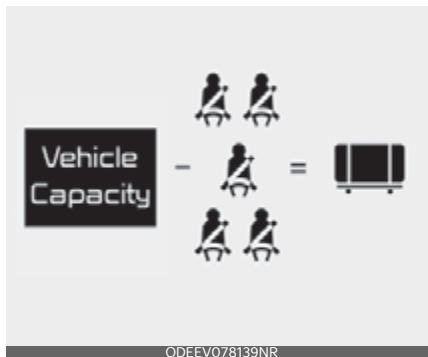

Example 2

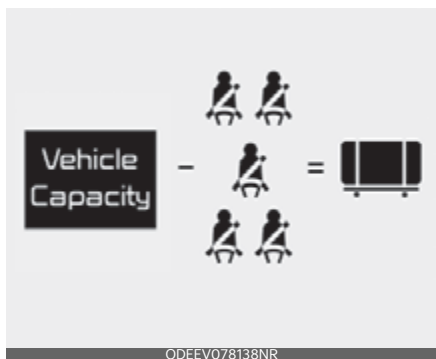

Item	Description	Total
A	Vehicle Capacity Weight	849 lbs. (385 kg)
B	Subtract Occupant Weight 161 lbs. (73 kg)×5	805 lbs. (365 kg)
C	Available Cargo and Luggage weight	44 lbs. (20 kg)

Item	Description	Total
A	Vehicle Capacity Weight	849 lbs. (385 kg)
B	Subtract Occupant Weight 150 lbs. (68 kg)×5	750 lbs. (340 kg)
C	Available Cargo and Luggage weight	99 lbs. (45 kg)

Refer to your vehicle's tire and loading information label for specific information about your vehicle's capacity weight and seating positions. The combined weight of the driver, passengers and cargo should never exceed your vehicle's capacity weight.

**Certification label**

The certification label is located on the driver's door sill at the center pillar.



This label shows the maximum allowable weight of the fully loaded vehicle. This is called the GVWR (Gross Vehicle Weight Rating). The GVWR includes the weight of the vehicle, all occupants and cargo.

This label also tells you the maximum weight that can be supported by the front and rear axles, called Gross Axle Weight Rating (GAWR).

To find out the actual loads on your front and rear axles, you need to go to a weigh station and weigh your vehicle. Your dealer can help you with this. Be sure to spread out your load equally on both sides of the centerline.

### **⚠ WARNING**

#### **Over loading**

Never exceed the GVWR for your vehicle, the GAWR for either the front or rear axle and vehicle capacity weight. Exceeding these

ratings can affect your vehicle's handling and braking ability.

The label will help you decide how much cargo and installed equipment your vehicle can carry.

If you carry items inside your vehicle - like suitcases, tools, packages, or anything else - they are moving as fast as the vehicle. If you have to stop or turn quickly, or if there is a crash, the items will keep going and can cause an injury if they strike the driver or a passenger.

### **⚠ WARNING**

#### **Over loading**

Do not overload your vehicle. Overloading your vehicle can cause heat buildup in your vehicle's tires and possible tire failure, increased stopping distances and poor vehicle handling--all of which may result in a crash.

### **\* NOTICE**

Overloading your vehicle may cause damage. Repairs would not be covered by your warranty. Do not overload your vehicle.

## Vehicle weight

This chapter will guide you in the proper loading of your vehicle and/or trailer, to keep your loaded vehicle weight within its design rating capability, with or without a trailer.

Properly loading your vehicle will provide maximum return of the vehicle design performance.

Before loading your vehicle, familiarize yourself with the following terms for determining your vehicle's weight ratings, with or without a trailer, from the vehicle's specifications and the compliance label:

### Base curb weight

This is the weight of the vehicle including a full tank of fuel and all standard equipment. It does not include passengers, cargo, or optional equipment.

### Vehicle curb weight

This is the weight of your new vehicle when you picked it up from your dealer plus any after-market equipment.

### Cargo weight

This figure includes all weight added to the Base Curb Weight, including cargo and optional equipment.

### GAW (Gross Axle Weight)

This is the total weight placed on each axle (front and rear) -

including vehicle curb weight and all payload.

### GAWR (Gross Axle Weight Rating)

This is the maximum allowable weight that can be carried by a single axle (front or rear). These numbers are shown on the compliance label. The total load on each axle must never exceed its GAWR.

### GVW (Gross Vehicle Weight)

This is the Base Curb Weight plus actual Cargo Weight plus passengers.

### GVWR (Gross Vehicle Weight Rating)

This is the maximum allowable weight of the fully loaded vehicle (including all options, equipment, passengers and cargo). The GVWR is shown on the certification label located on the driver's door sill.

### CAUTION

Do not use replacement tires with lower load carrying capacities than the original tires because they may lower your vehicle's GVWR and GAWR limitations. Replacement tires with a higher limit than the original tires do not increase the GVWR and GAWR limitations.

---

## Overloading

### **WARNING**

The Gross Axle Weight Rating (GAWR) and the Gross Vehicle Weight Rating (GVWR) for your vehicle are on the Certification Label attached to the driver's (or front passenger's) door. Exceeding these ratings can cause an accident or vehicle damage. You can calculate the weight of your load by weighing the items (and people) before putting them in the vehicle. Be careful not to overload your vehicle

---





<b>Forward Collision-Avoidance Assist (FCA) (Front view camera only).....</b>	<b>6-4</b>
• Forward Collision-Avoidance Assist settings .....	6-5
• Forward Collision-Avoidance Assist operation .....	6-7
<b>Forward Collision-Avoidance Assist (FCA) (Sensor fusion)..</b>	<b>6-16</b>
• Forward Collision-Avoidance Assist settings .....	6-17
• Forward Collision-Avoidance Assist operation .....	6-20
<b>Lane Keeping Assist (LKA).....</b>	<b>6-31</b>
• Lane Keeping Assist settings .....	6-31
• Lane Keeping Assist operation.....	6-33
• Lane Keeping Assist malfunction and limitations.....	6-35
<b>Blind-Spot Collision-Avoidance Assist (BCA) .....</b>	<b>6-37</b>
• Blind-Spot Collision-Avoidance Assist settings.....	6-39
• Blind-Spot Collision-Avoidance Assist operation .....	6-41
• Blind-Spot Collision-Avoidance Assist malfunction and limitations.....	6-44
<b>Safe Exit Warning (SEW) .....</b>	<b>6-48</b>
• Safe Exit Warning settings .....	6-48
• Safe Exit Warning operation .....	6-49
• Safe Exit Warning malfunction and limitations .....	6-50
<b>Safe Exit Assist (SEA).....</b>	<b>6-52</b>
• Safe Exit Assist settings.....	6-53
• Safe Exit Assist operation.....	6-54
• Safe Exit Assist malfunction and limitations .....	6-56
<b>Driver Attention Warning (DAW) .....</b>	<b>6-57</b>
• Driver Attention Warning settings .....	6-58
• Driver Attention Warning operation .....	6-60
• Driver Attention Warning malfunction and limitations.....	6-62
<b>Cruise Control (CC) .....</b>	<b>6-65</b>
• Cruise Control switch .....	6-65

# 6 Driver assistance system

- Setting Cruise Control speed.....6-66
- Increasing Cruise Control set speed.....6-66
- Decreasing Cruise Control set speed.....6-66
- Accelerating temporarily with Cruise Control on.....6-66
- Cruise Control will be temporarily canceled when: .....6-67
- Restarting cruising speed at more than approximately  
20 mph (32 km/h) .....6-67
- Turning Cruise Control off .....6-68
- Smart Cruise Control (SCC) ..... 6-68**
- Smart Cruise Control settings .....6-69
- Smart Cruise Control operation.....6-73
- Smart Cruise Control display and control.....6-73
- Smart Cruise Control malfunction and limitations.....6-78
- Navigation-based Smart Cruise Control (NSCC) ..... 6-84**
- Navigation-based Smart Cruise Control settings ..... 6-84
- Navigation-based Smart Cruise Control operation .....6-85
- Lane Following Assist (LFA) ..... 6-90**
- Lane Following Assist settings ..... 6-91
- Lane Following Assist operation.....6-92
- Lane Following Assist malfunction and limitations.....6-94
- Highway Driving Assist (HDA) ..... 6-95**
- Highway Driving Assist settings .....6-96
- Highway Driving Assist operation .....6-97
- Highway Driving Assist malfunction and limitations.....6-99
- Rear View Monitor (RVM)..... 6-101**
- Detecting sensor .....6-101
- Rear View Monitor settings .....6-101
- Warning Methods .....6-102
- Rear view .....6-103
- Rear View Monitor malfunction and limitations.....6-104

<b>Surround View Monitor (SVM)</b> .....	<b>6-105</b>
• Surround View Monitor settings.....	6-105
• Warning Methods.....	6-107
• Surround View Monitor operation .....	6-108
• Surround View Monitor malfunction and limitations .....	6-109
<b>Reverse Parking Distance Warning (PDW)</b> .....	<b>6-110</b>
• Reverse Parking Distance Warning settings.....	6-112
• Reverse Parking Distance Warning operation .....	6-112
• Types of warning sound and indicator .....	6-113
• Reverse Parking Distance Warning malfunction and precautions.....	6-113
<b>Forward/Reverse Parking Distance Warning (PDW)</b> .....	<b>6-114</b>
• Forward/Reverse Parking Distance Warning settings.....	6-115
• Forward/Reverse Parking Distance Warning operation.....	6-116
• Forward/Reverse Parking Distance Warning malfunction and limitations.....	6-117
<b>Rear Cross-Traffic Collision-Avoidance Assist (RCCA)</b> .....	<b>6-119</b>
• Rear Cross-Traffic Collision-Avoidance Assist settings.....	6-120
• Rear Cross-Traffic Collision-Avoidance Assist operation.....	6-122
• Rear Cross-Traffic Collision-Avoidance Assist malfunction and limitations.....	6-126
<b>Reverse Parking Collision-Avoidance Assist (PCA)</b> .....	<b>6-130</b>
• Reverse Parking Collision- Avoidance Assist settings .....	6-130
• Reverse Parking Collision- Avoidance Assist operation .....	6-132
• Reverse Parking Collision- Avoidance Assist malfunction and limitations.....	6-133
<b>Declaration of conformity</b> .....	<b>6-138</b>

## Driver assistance system

### \* INFORMATION

Driver Assistance system functions can be updated by infotainment software version. Descriptions for each function of the system may differ from the owners' manual once updated. Refer to the user's manual provided in the infotainment system and the quick reference guide.

## Forward Collision-Avoidance Assist (FCA) (Front view camera only)

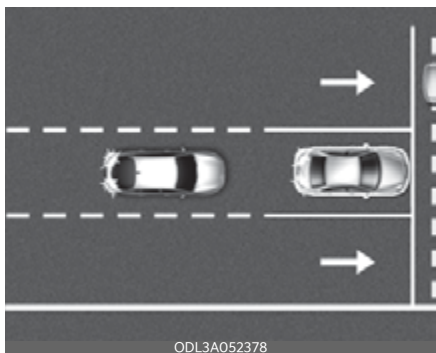

Forward Collision-Avoidance Assist is designed to help detect and monitor the vehicle ahead or help detect a pedestrian in the roadway and warn the driver that a collision is imminent with a warning message and an audible warning, and if necessary, apply emergency braking.

## Detecting sensor



[1]: Front view camera

Refer to the picture for the detailed location of the detecting sensors.

### ⚠ CAUTION

Take the following precautions to maintain optimal performance of the detecting sensor:

- Never disassemble the detecting sensor or sensor assembly, or apply any impact on it.
- Never install any accessories or stickers on the front windshield, or tint the front windshield.
- If the detecting sensors have been replaced or repaired, have your vehicle inspected by an authorized Kia dealer.
- Pay extreme caution to keep the front view camera dry.
- Never place any reflective objects (i.e. white paper, mirror) over the dashboard. Any light reflection may prevent Forward Collision-Avoidance Assist from functioning properly.

## Forward Collision-Avoidance Assist settings

### Forward Safety

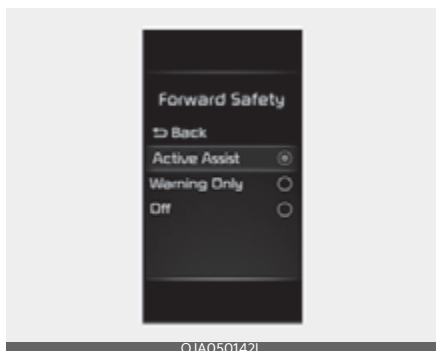

With the ENGINE START/STOP button in the ON position, select or deselect 'Driver Assistance → Forward Safety' from the Settings menu to set whether or not to use each function.

- If 'Active Assist' is selected, Forward Collision-Avoidance Assist will warn the driver with a warning message and an audible warning depending on the collision risk levels. Braking assist will be applied depending on the collision risk.
- If 'Warning Only' is selected, Forward Collision-Avoidance Assist will warn the driver with a warning message and an audible warning depending on the collision risk levels. Braking will not be assisted.
- If 'Off' is selected, Forward Collision-Avoidance Assist will be turned off.

The  warning light will appear on the cluster.

The driver can monitor Forward Collision-Avoidance Assist ON/OFF status from the Settings menu. If the 

warning light remains ON when Forward Collision-Avoidance Assist is ON, have your vehicle inspected by an authorized Kia dealer.

### ⚠ WARNING

When the engine is restarted, Forward Collision-Avoidance Assist will always turn on. However, if 'Off' is selected after the engine is restarted, the driver should always be aware of the surroundings and drive safely.

### ⚠ CAUTION

If 'Warning Only' is selected, braking is not assisted.

### \* NOTICE

Forward Collision-Avoidance Assist will turn off when ESC is turned off by pressing and holding the ESC OFF button. The  warning light will appear on the cluster.

### Warning Timing

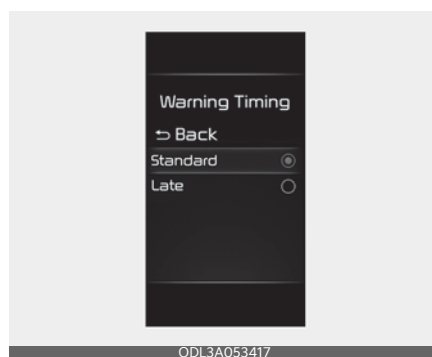

With the ENGINE START/STOP button in the ON position, select 'Driver Assistance → Warning Timing' from the Settings menu to change the initial warning acti-

vation time for Forward Collision-Avoidance Assist.

When the vehicle is first delivered, Warning Timing is set to 'Standard'.

If you change the Warning Timing, the warning time of other Driver Assistance system may change.

### CAUTION

- The setting of the Warning Timing applies to all functions of Forward Collision-Avoidance Assist.
- Even though 'Standard' is selected for Warning Timing, if the front vehicle suddenly stops, the initial warning activation time may seem late.
- Select 'Late' for Warning Timing when traffic is light and when driving speed is slow.

## Warning Methods

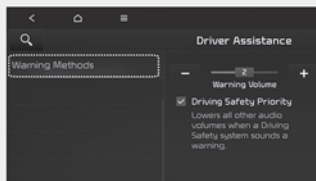

ODL3A053418

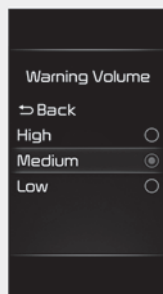

ODL3A051372

You can adjust the Warning Methods with the ignition switch or ENGINE START/ STOP button in the ON position.

- Warning Volume : Select 'User Settings → Driver Assistance → Warning Volume' on the instrument cluster or 'Settings → Vehicle → Driver Assistance → Warning Methods → Warning Volume' on the Infotainment system.
- Driving Safety Priority : Select 'Vehicle Settings → Driver Assistance → Warning Methods → Driving Safety Priority' on the Infotainment system. For safe driving, the audio volume will temporarily decrease to warn the driver with the audible warning.

**\* NOTICE**

- Ensure that Warning Methods you have set may apply to the warning volume of other driver assistance systems.
- Warning Methods will maintain its last setting even if the vehicle is restarted.
- The setting menu may not be available for your vehicle depending on the vehicle features and specifications.
- Descriptions of each driver assistance system may be slightly different from the owner's manual after updating the software of your infotainment system. In this case, scan the QR code in the infotainment system manual to access the web manual to review the changes.
- Depending on your update, the menu may be displayed as 'Warning Sound' or 'Warning methods'.

**Forward Collision-Avoidance Assist operation****Warning and control**

The basic function for Forward Collision-Avoidance Assist is to warn and control the vehicle depending on the collision level: 'Collision Warning', 'Emergency Braking' and 'Stopping vehicle and ending brake control'.

**Collision Warning**

- To warn the driver of a collision, the 'Collision Warning' warning message will appear on the cluster, and an audible warning will sound.
- If a vehicle is detected in front, the function will operate when your driving speed is between approximately 6~112 mph (10~180 km/h).
- If a pedestrian is detected in front, the function will operate when your driving speed is between approximately 6~37 mph (10~60 km/h).
- If 'Active Assist' is selected, braking may be assisted.



## Emergency Braking



- To warn the driver that emergency braking will be assisted, the 'Emergency Braking' warning message will appear on the cluster, and an audible warning will sound.
- If a vehicle is detected in front, the function will operate when your driving speed is between approximately 6~37 mph (10~60 km/h).
- If a pedestrian is detected in front, the function will operate when your driving speed is between approximately 6~37 mph (10~60 km/h).
- In emergency braking situation, braking is assisted with strong braking power by the function to help prevent collision with the vehicle or pedestrian.

## Stopping vehicle and ending brake control



- When the vehicle is stopped due to emergency braking, the 'Drive carefully' warning message will appear on the cluster.  
For your safety, the driver should depress the brake pedal immediately and check the surroundings.
- Brake control will end after the vehicle is stopped by emergency braking for approximately 2 seconds.

### **⚠ WARNING**

- For your safety, change the Settings after parking the vehicle at a safe location.
- With 'Active Assist' or 'Warning Only' selected, when ESC is turned off by pressing and holding the ESC OFF button, Forward Collision-Avoidance Assist will turn off automatically. In this case, the function cannot be set from the Settings menu and the warning light will appear on the cluster which is normal. If ESC is turned on by pressing the ESC OFF button, Forward Collision-Avoidance Assist will maintain the last setting.

- Forward Collision-Avoidance Assist does not operate in all situations or cannot avoid all collisions.
- The driver should hold the responsibility to control the vehicle. Do not solely depend on Forward Collision-Avoidance Assist. Rather, maintain a safe braking distance, and if necessary, depress the brake pedal to reduce driving speed or to stop the vehicle.
- Never deliberately operate Forward Collision-Avoidance Assist on people, animal, objects, etc. It may cause serious injury or death.
- Forward Collision-Avoidance Assist may not operate if the driver depresses the brake pedal to avoid collision.
- Depending on the road and driving conditions, Forward Collision-Avoidance Assist may warn the driver late or may not warn the driver.
- During Forward Collision-Avoidance Assist operation, the vehicle may stop suddenly injuring passengers and shifting loose objects. Always have the seat belt on and keep loose objects secured.
- If any other function's warning message is displayed or audible warning is generated, Forward Collision-Avoidance Assist warning message may not be displayed and audible warning may not be generated.
- You may not hear the warning sound of Forward Collision-Avoidance Assist if the surrounding is noisy.
- Forward Collision-Avoidance Assist may turn off or may not operate properly or may operate unnecessarily

depending on the road conditions and the surroundings.

### **⚠ WARNING**

- Even if there is a problem with Forward Collision-Avoidance Assist, the vehicle's basic braking performance will operate normally.
- During emergency braking, braking control by Forward Collision-Avoidance Assist will automatically cancel when the driver excessively depresses the accelerator pedal or sharply steers the vehicle.

### **⚠ CAUTION**

Depending on the condition of the vehicle, pedestrian in front and the surroundings, the speed range to operate Forward Collision-Avoidance Assist may reduce. Forward Collision-Avoidance Assist may only warn the driver, or it may not operate.



### **\* NOTICE**

- When a collision is imminent, the Forward Collision-Avoidance Assist may assist the driver with brakes if the driver fails to brake enough.
- The images or colors may be displayed differently depending on the instrument panel specifications or theme.

## Forward Collision-Avoidance Assist malfunction and limitations

### Forward Collision-Avoidance Assist malfunction



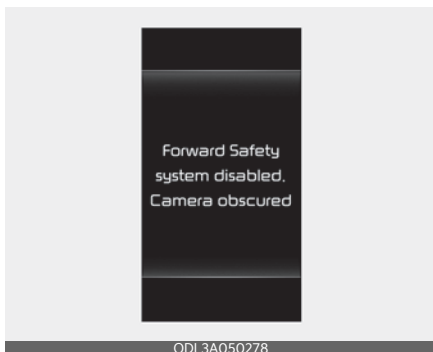

When Forward Collision-Avoidance Assist is not working properly, the 'Check Forward Safety system' warning message will appear, and the  and  warning lights will appear on the cluster. In this case, have your vehicle inspected by an authorized Kia dealer.

### Forward Collision-Avoidance Assist disabled



When the front windshield where the front view camera is located, is covered

with foreign material, such as snow or rain, it can reduce the detecting performance and temporarily limit or disable Forward Collision-Avoidance Assist.

If this occurs, the 'Forward Safety system disabled. Camera obscured' warning message, and the  and  warning lights will appear on the cluster.

Forward Collision-Avoidance Assist will operate normally when snow, rain or foreign matter is removed. Always keep it clean.

If the function does not operate normally after obstruction (snow, rain, or foreign material) is removed, have your vehicle inspected by an authorized Kia dealer.

### **WARNING**

- Even though the warning message or warning light does not appear on the cluster, Forward Collision-Avoidance Assist may not properly operate.
- Forward Collision-Avoidance Assist may not properly operate in an area (e.g. open terrain), where any substance are not detected after turning ON the engine.

### Limitations of Forward Collision-Avoidance Assist

Forward Collision-Avoidance Assist may not operate normally, or Forward Collision-Avoidance Assist may operate unexpectedly under the following circumstances:

- The detecting sensor or the surroundings are contaminated or damaged
- The temperature around the front view camera is high or the detecting sensor or the surroundings are contaminated or damage

- The camera lens is contaminated due to tinted, filmed or coated windshield, damaged glass, or stuck of foreign material (sticker, bug, etc.) on the glass
- Moisture is not removed or frozen on the windshield
- Washer fluid is continuously sprayed, or the wiper is on
- Driving in heavy rain or snow, or thick fog
- The field of view of the front view camera is obstructed by sun glare
- Street light or light from an oncoming vehicle is reflected on the wet road surface, such as a puddle on the road
- An object is placed on the dashboard
- Your vehicle is being towed
- The surrounding is very bright
- The surrounding is very dark, such as in a tunnel, etc.
- The brightness changes suddenly, for example when entering or exiting a tunnel
- The brightness outside is low, and the headlamps are not on or are not bright
- Driving through steam, smoke or shadow
- Only part of the vehicle, pedestrian is detected
- The vehicle in front is a bus, heavy truck, truck with a unusually shaped luggage, trailer, etc.
- The vehicle in front has no tail lights, tail lights are located unusually, etc.
- The brightness outside is low, and the tail lamps are not on or are not bright
- The rear of the front vehicle is small or the vehicle does not look normal, such as when the vehicle is tilted, over-turned, or the side of the vehicle is visible, etc.
- The front vehicle's ground clearance is low or high
- A vehicle or pedestrian suddenly cuts in front
- The vehicle in front is detected late
- The vehicle in front is suddenly blocked by an obstacle
- The vehicle in front suddenly changes lane or suddenly reduces speed
- The vehicle in front is bent out of shape
- The front vehicle's speed is fast or slow
- The vehicle in front steers in the opposite direction of your vehicle to avoid a collision
- With a vehicle in front, your vehicle changes lane at low speed
- The vehicle in front is covered with snow
- You are departing or returning to the lane
- Unstable driving
- You are on a roundabout and the vehicle in front is not detected
- You are continuously driving in a circle
- The vehicle in front has an unusual shape
- The vehicle in front is driving uphill or downhill.
- The pedestrian is not fully detected, for example, if the pedestrian is leaning over or is not fully walking upright
- The pedestrian is wearing clothing or equipment that makes it difficult to detect as a pedestrian

Following image shows the image the sensor recognizes as vehicle and pedestrian.



- The pedestrian in front is moving very quickly
- The pedestrian in front is short or is posing a low posture
- The pedestrian in front has impaired mobility
- The pedestrian in front is moving intersected with the driving direction
- There is a group of pedestrians or a large crowd in front
- The pedestrian is wearing clothing that easily blends into the background, making it difficult to detect
- The pedestrian is difficult to distinguish from the similar shaped structure in the surroundings
- You are driving by a pedestrian, traffic signs, structures, etc. near the intersection
- You are driving by a pedestrian, traffic signs, structures, etc. near the intersection
- Driving in a parking lot
- Driving through a tollgate, construction area, unpaved road, partial paved road, uneven road, speed bumps, etc.

- Driving on an incline road, curved road, etc.
- Driving through a roadside with trees or streetlights
- The adverse road conditions cause excessive vehicle vibrations while driving
- Your vehicle height is low or high due to heavy loads, abnormal tire pressure, etc.
- Driving through a narrow road where trees or grass are overgrown
- There is interference by electromagnetic waves, such as driving in an area with strong radio waves or electrical noise

**⚠ WARNING**

- Driving on a curved road



Forward Collision-Avoidance Assist may not detect other vehicle, pedestrian in front of you on curved roads adversely affecting the performance of the sensors. This may result in no warning or braking assist when necessary.

When driving on a curve, you must maintain a safe braking distance, and if necessary, steer the vehicle and depress the brake pedal to reduce your driving speed in order to maintain a safe distance.



Forward Collision-Avoidance Assist may detect a vehicle, pedestrian in the next lane or outside the lane when driving on a curved road.

If this occurs, Forward Collision-Avoidance Assist may unnecessarily warn the driver and control the brake.

Always check the traffic conditions around the vehicle.

- Driving on an inclined road



Forward Collision-Avoidance Assist may not detect other vehicle, pedestrian in front of you while driving uphill or downhill adversely affecting the performance of the sensors.

This may result in unnecessary warning or braking assist when necessary. Also, vehicle speed may rapidly decrease when a vehicle or pedestrian ahead is suddenly detected.

Always have your eyes on the road while driving uphill or downhill and if necessary, steer your vehicle and depress the brake pedal to reduce your driving speed in order to maintain a safe distance.

- Changing lanes

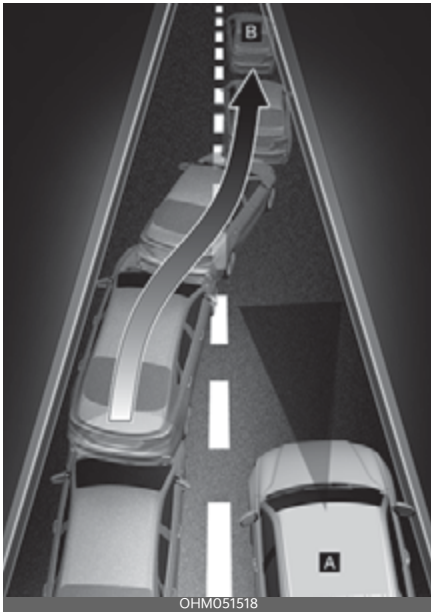

[A]: Your vehicle

[B]: Lane changing vehicle

When a vehicle (B) moves into your lane from an adjacent lane, it cannot be detected by the sensor until it is in the sensor's detection range. Forward Collision-Avoidance Assist may not immediately detect the vehicle when the vehicle changes lanes abruptly. In this case, you must maintain a safe braking distance, and if necessary, steer your vehicle and depress the brake pedal to reduce your driving speed in order to maintain a safe distance.



[A]: Your vehicle

[B]: Lane changing vehicle,

[C]: Same lane vehicle

When a vehicle (B) in front of you merges out of the lane, Forward Collision-Avoidance Assist may not immediately detect the vehicle (C) that is now in front of you. In this case, you must maintain a safe braking distance, and if necessary, steer your vehicle and depress the brake pedal to reduce your driving speed in order to maintain a safe distance.

- Detecting vehicle



If the vehicle in front of you has cargo that extends rearward from the cab, or when the vehicle in front of you has higher ground clearance, additional special attention is required. Forward Collision-Avoidance Assist may not be able to detect the cargo extending from the vehicle. In these instances, you must maintain a safe braking distance from the rearmost object, and if necessary, steer your vehicle and depress the brake pedal to reduce your driving speed in order to maintain distance.

### **⚠ WARNING**

- When you are towing a trailer or another vehicle, we recommend that Forward Collision-Avoidance Assist is turned off due to safety reasons.
- Forward Collision-Avoidance Assist may operate if objects that are similar in shape or characteristics to vehicle and pedestrian are detected.
- Forward Collision-Avoidance Assist does not operate on bicycles, motorcycles, or smaller wheeled objects, such as luggage bags, shopping carts, or strollers that are dragged by a pedestrian.

- Forward Collision-Avoidance Assist may not operate normally if it is interfered with by strong electromagnetic waves.
- Forward Collision-Avoidance Assist may not operate for approximately 15 seconds after the vehicle is started, or the front view camera is initialized.

### **This device complies with Part 15 of the FCC rules.**

Operation is subject to the following three conditions:

1. This device may not cause harmful interference, and
2. This device must accept any interference received, including interference that may cause undesired operation.
3. Changes or modifications not expressly approved by the party responsible for compliance could void the user's authority to operate the device.

### **Radio frequency radiation exposure information:**

This equipment complies with FCC radiation exposure limits set forth for an uncontrolled environment. This equipment should be installed and operated with minimum distance of 8 in (20 cm) between the radiator (antenna) and your body.

This transmitter must not be colocated or operating in conjunction with any other antenna or transmitter.



## Forward Collision-Avoidance Assist (FCA) (Sensor fusion) (if equipped)

### Basic function

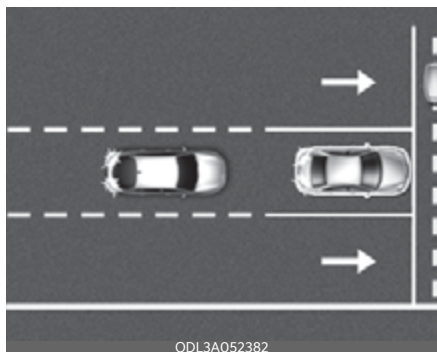

Forward Collision-Avoidance Assist is designed to help detect and monitor the vehicle ahead or help detect a pedestrian or cyclist in the roadway and warn the driver that a collision is imminent with a warning message and an audible warning, and if necessary, apply emergency braking.

### Junction Turning function



Junction Turning function will help avoid a collision with an oncoming vehicle in an adjacent lane when turning left at a

crossroad with the turn signal on by applying emergency braking.

### Detecting sensor

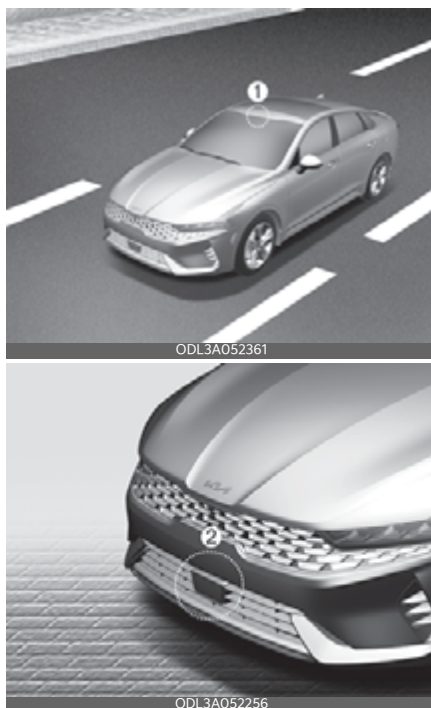

[1]: Front view camera

[2]: Front radar

Refer to the picture for the detailed location of the detecting sensors.

### CAUTION

Take the following precautions to maintain optimal performance of the detecting sensor:

- Never disassemble the detecting sensor or sensor assembly, or apply any impact on it.
- Never install any accessories or stickers on the front windshield, or tint the front windshield.

- If the detecting sensors have been replaced or repaired, have your vehicle inspected by an authorized Kia dealer.
- Pay extreme caution to keep the front view camera dry.
- Never place any reflective objects (i.e. white paper, mirror) over the dashboard. Any light reflection may prevent Forward Collision-Avoidance Assist from functioning properly.
- Do not apply license plate frame or objects, such as a bumper sticker, film or a bumper guard, near the front radar cover.
- Always keep the front radar and cover clean and free of dirt and debris. Use only a soft cloth to wash the vehicle. Do not spray pressurized water directly on the sensor or sensor cover.
- If unnecessary force has been applied to the radar or around the radar, Forward Collision-Avoidance Assist may not properly operate even though a warning message does not appear on the cluster. In this case, have your vehicle inspected by an authorized Kia dealer.
- The genuine Kia front radar sensor covers are parts with quality and performance ensured. If arbitrarily applying paint on or changing the cover, Forward Collision-Avoidance Assist may not function properly. Use only Kia Genuine Parts or those of an equivalent standard with proven quality and performance to repair or replace the radar sensor covers.

## Forward Collision-Avoidance Assist settings

### Forward Safety

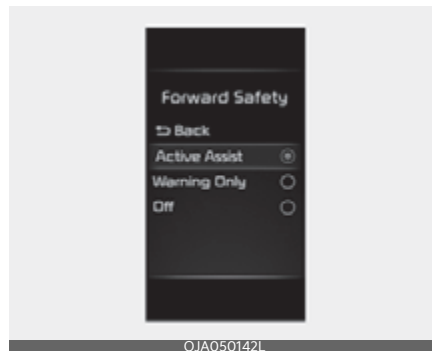

With the ENGINE START/STOP button in the ON position, select or deselect 'Driver Assistance → Forward Safety' from the Settings menu to set whether or not to use each function.

- If you select "Active Assist", Forward Collision-Avoidance Assist activates. Forward Collision-Avoidance Assist produces warning messages and warning alarms in accordance with the collision risk levels. Braking assist will be applied in accordance with the collision risk.
- If you select 'Warning Only', Forward Collision-Avoidance Assist activates and produces only warning alarms in accordance with the collision risk levels. Braking assist will not be applied in this setting.
- If you select 'Off', Forward Collision-Avoidance Assist deactivates. The



warning light will appear on the cluster.

The driver can monitor Forward Collision-Avoidance Assist ON/OFF status

from the Settings menu. If the  warning light remains ON when Forward Collision-Avoidance Assist is ON, have your vehicle inspected by an authorized Kia dealer.

### WARNING

When the engine is restarted, Forward Collision-Avoidance Assist will always turn on. However, if 'Off' is selected after the engine is restarted, the driver should always be aware of the surroundings and drive safely.

### CAUTION

- If 'Warning Only' is selected, braking is not assisted.
- The settings for Forward Safety include 'Basic function' and 'Junction Turning'.

### \* NOTICE

Forward Collision-Avoidance Assist will turn off when ESC is turned off by pressing and holding the ESC OFF button. The

 warning light will appear on the cluster.

## Warning Timing

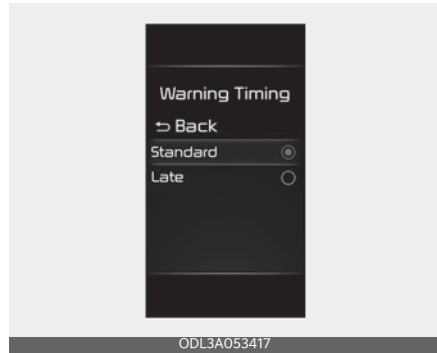

With the ENGINE START/STOP button in the ON position, select 'Driver Assistance → Warning Timing' from the Settings menu to change the initial warning activation time for Forward Collision-Avoidance Assist.

When the vehicle is first delivered, Warning Timing is set to 'Standard'.

If you change the Warning Timing, the warning time of other Driver Assistance systems may change.

### CAUTION

- The setting of the Warning Timing applies to all functions of Forward Collision-Avoidance Assist.
- Even though 'Standard' is selected for Warning Timing, if the front vehicle suddenly stops, the initial warning activation time may seem late.
- Select 'Late' for Warning Timing when traffic is light and when driving speed is slow.

## Warning Methods



You can adjust the Warning Methods with the ignition switch or ENGINE START/ STOP button in the ON position.

- **Warning Volume** : Select 'User Settings → Driver Assistance → Warning Volume' on the instrument cluster or 'Settings → Vehicle → Driver Assistance → Warning Methods → Warning Volume' on the Infotainment system.
- **Driving Safety Priority** : Select 'Vehicle Settings → Driver Assistance → Warning Methods → Driving Safety Priority' on the Infotainment system. For safe driving, the audio volume will temporarily decrease to warn the driver with the audible warning.

### \* NOTICE

- Ensure that Warning Methods you have set may apply to the warning volume of other driver assistance systems.
- Warning Methods will maintain its last setting even if the vehicle is restarted.
- The setting menu may not be available for your vehicle depending on the vehicle features and specifications.
- Descriptions of each driver assistance system may be slightly different from the owner's manual after updating the software of your infotainment system. In this case, scan the QR code in the infotainment system manual to access the web manual to review the changes.
- Depending on your update, the menu may be displayed as 'Warning Sound' or 'Warning methods'.

## Forward Collision-Avoidance Assist operation

### Basic function

#### Warning and control

The basic function for Forward Collision-Avoidance Assist is to warn and control the vehicle depending on the collision level: 'Collision Warning', 'Emergency Braking' and 'Stopping vehicle and ending brake control'.

#### Collision Warning

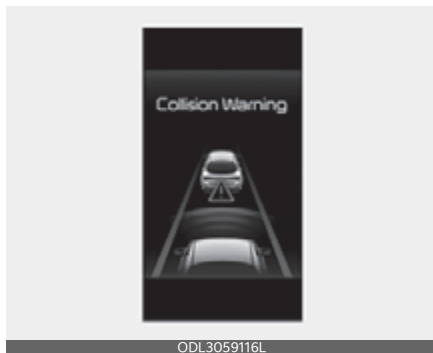

- To warn the driver of a collision, the 'Collision Warning' warning message will appear on the cluster, and an audible warning will sound.
- If a vehicle is detected in front, the function will operate when your driving speed is between approximately 6~112 mph (10~180 km/h).
- If a pedestrian or cyclist is detected in front, the function will operate when your driving speed is between approximately 6~53 mph (10~85 km/h).
- If 'Active Assist' is selected, braking may be assisted.

#### Emergency Braking

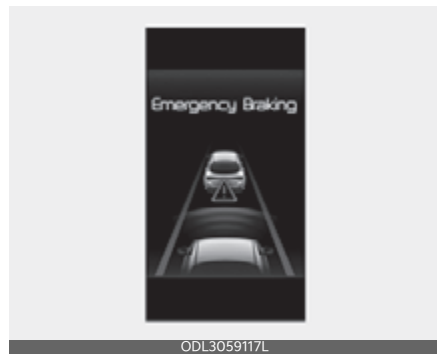

- To warn the driver that emergency braking will be assisted, the 'Emergency Braking' warning message will appear on the cluster, and an audible warning will sound.
- If a vehicle is detected in front, the function will operate when your driving speed is between approximately 6~47 mph (10~75 km/h).
- If a pedestrian or cyclist is detected in front, the function will operate when your driving speed is between approximately 6~40 mph (10~65 km/h).
- In emergency braking situation, braking is assisted with strong braking power by the function to help prevent collision with the vehicle, pedestrian or cyclist ahead.

## Stopping vehicle and ending brake control



- When the vehicle is stopped due to emergency braking, the 'Drive carefully' warning message will appear on the cluster.  
For your safety, the driver should depress the brake pedal immediately and check the surroundings.
- Brake control will end after the vehicle is stopped by emergency braking for approximately 2 seconds.

## Junction Turning function

### Warning and control

Junction Turning function will warn and control the vehicle depending on the collision level: 'Collision Warning', 'Emergency Braking' and 'Stopping vehicle and ending brake control'.

### Collision Warning



- To warn the driver of a collision, the 'Collision Warning' warning message will appear on the cluster, and an audible warning will sound.
- The function will operate when your driving speed is between approximately 6~19 mph (10~30 km/h) and the oncoming vehicle speed is between approximately 19~44 mph (30~70 km/h).
- If 'Active Assist' is selected, braking may be assisted.

### Emergency Braking



- To warn the driver that emergency braking will be assisted, the 'Emergency Braking' warning message will appear on the cluster, and an audible warning will sound.
- The function will operate when your driving speed is between approximately 6~19 mph (10~30 km/h) and the oncoming vehicle speed is between approximately 19~44 mph (30~70 km/h).
- In emergency braking situation, braking is assisted with strong braking power by the function to help prevent collision with the oncoming vehicle.

### Stopping vehicle and ending brake control



- When the vehicle is stopped due to emergency braking, the 'Drive carefully' warning message will appear on the cluster.  
For your safety, the driver should depress the brake pedal immediately and check the surroundings.
- Brake control will end after the vehicle is stopped by emergency braking for approximately 2 seconds.

### **⚠ WARNING**

- For your safety, change the Settings after parking the vehicle at a safe location.
- With 'Active Assist' or 'Warning Only' selected, when ESC is turned off by pressing and holding the ESC OFF button, Forward Collision-Avoidance Assist will turn off automatically. In this case, Forward Collision-Avoidance Assist cannot be set from the Settings menu and the  warning light will appear on the cluster which is normal. If ESC is turned on by pressing the ESC OFF button, Forward Collision-Avoidance Assist will maintain the last setting.

- Forward Collision-Avoidance Assist does not operate in all situations or cannot avoid all collisions.
- The driver should hold the responsibility to control the vehicle. Do not solely depend on Forward Collision-Avoidance Assist. Rather, maintain a safe braking distance, and if necessary, depress the brake pedal to reduce driving speed or to stop the vehicle.
- Never deliberately operate Forward Collision-Avoidance Assist on people, animal, objects, etc. It may cause serious injury or death.
- Forward Collision-Avoidance Assist may not operate if the driver depresses the brake pedal to avoid collision.
- Depending on the road and driving conditions, Forward Collision-Avoidance Assist may warn the driver late or may not warn the driver.
- During Forward Collision-Avoidance Assist operation, the vehicle may stop suddenly injuring passengers and shifting loose objects. Always have the seat belt on and keep loose objects secured.
- If any other function's warning message is displayed or audible warning is generated, Forward Collision-Avoidance Assist warning message may not be displayed and audible warning may not be generated.
- You may not hear the warning sound of Forward Collision-Avoidance Assist if the surrounding is noisy.
- Forward Collision-Avoidance Assist may turn off or may not operate properly or may operate unnecessarily

depending on the road conditions and the surroundings.

### WARNING

- Even if there is a problem with Forward Collision-Avoidance Assist, the vehicle's basic braking performance will operate normally.
- During emergency braking, braking control by Forward Collision-Avoidance Assist will automatically cancel when the driver excessively depresses the accelerator pedal or sharply steers the vehicle.

### CAUTION

- Depending on the condition of the vehicle, pedestrian and cyclist in front and the surroundings, the speed range to operate Forward Collision-Avoidance Assist may reduce. Forward Collision-Avoidance Assist may only warn the driver, or it may not operate.
- Forward Collision-Avoidance Assist will operate under certain conditions by judging the risk level based on the condition of the oncoming vehicle, driving direction, speed and surroundings.

### NOTICE



When a collision is imminent, the Forward Collision-Avoidance Assist may assist the driver with brakes if the driver fails to brake enough.



### Forward Collision-Avoidance Assist malfunction and limitations

#### Forward Collision-Avoidance Assist malfunction



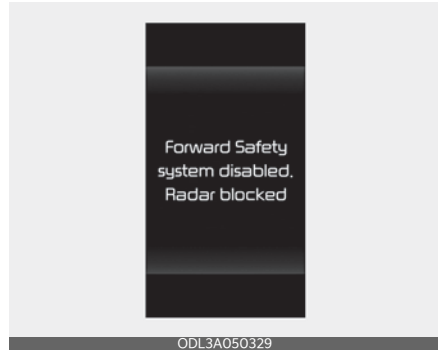
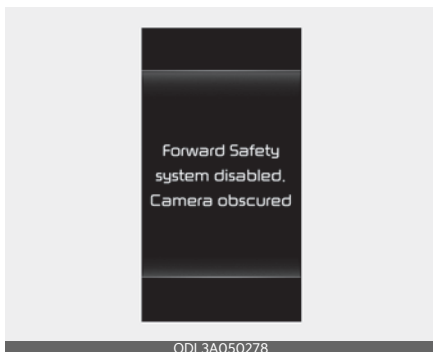

When Forward Collision-Avoidance Assist is not working properly, the 'Check Forward Safety system' warning message will appear, and the  and  warning lights will appear on the cluster. In this case, have your vehicle inspected by an authorized Kia dealer.

#### Forward Collision-Avoidance Assist disabled



When the front windshield where the front view camera is located, front radar cover, bumper or sensor is covered with foreign material, such as snow or rain, it can reduce the detecting performance and temporarily limit or disable Forward Collision-Avoidance Assist.

If this occurs the 'Forward Safety system disabled. Camera obscured' or the 'Forward Safety system disabled. Radar blocked' warning message, and the  and  warning lights will appear on the cluster.

Forward Collision-Avoidance Assist will operate normally when snow, rain or foreign matter is removed. Always keep it clean.

If Forward Collision-Avoidance Assist does not operate normally after obstruction (snow, rain, or foreign material) is removed, have your vehicle inspected by an authorized Kia dealer.

#### **WARNING**

- Even though the warning message or warning light does not appear on the cluster, Forward Collision-Avoidance Assist may not properly operate.
- Forward Collision-Avoidance Assist may not properly operate in an area

(e.g. open terrain), where any substance are not detected after turning ON the engine.

### Limitations of Forward Collision-Avoidance Assist

Forward Collision-Avoidance Assist may not operate normally, or it may operate unexpectedly under the following circumstances:

- The detecting sensor or the surroundings are contaminated or damaged
- The temperature around the front view camera is high or low
- The camera lens is contaminated due to tinted, filmed or coated windshield, damaged glass, or substances from a foreign material (sticker, bug, etc.) on the glass
- Moisture is not removed or is frozen on the windshield
- Washer fluid is continuously sprayed, or the wiper is on
- Driving in heavy rain or snow, or thick fog
- The field of view of the front view camera is obstructed by sun glare
- Street light or light from an oncoming vehicle is reflected on the wet road surface, such as a puddle on the road
- An object is placed on the dashboard
- Your vehicle is being towed
- The surrounding is very bright
- The surrounding is very dark, such as in a tunnel, etc.
- The brightness changes suddenly, for example when entering or exiting a tunnel
- The brightness outside is low, and the headlamps are not on or are not bright
- Driving through steam, smoke or shadow
- Only part of the vehicle, pedestrian or cyclist is detected
- The vehicle in front is a bus, heavy truck, truck with a unusually shaped luggage, trailer, etc.
- The vehicle in front has no tail lights, tail lights are located unusually, etc.
- The brightness outside is low, and the tail lamps are not on or are not bright
- The rear of the front vehicle is small or the vehicle does not look normal, such as when the vehicle is tilted, overturned, or the side of the vehicle is visible, etc.
- The front vehicle's ground clearance is low or high
- A vehicle, pedestrian or cyclist suddenly cuts in front
- The bumper around the front radar is impacted, damaged or the front radar is out of position
- The temperature around the front radar is high or low
- Driving through a tunnel or iron bridge
- Driving in large areas where there are few vehicles or structures (i.e. desert, meadow, suburb, etc.)
- Driving near areas containing metal substances, such as a construction zone, railroad, etc.
- A material is near that reflects very well on the front radar, such as a guardrail, nearby vehicle, etc.
- The cyclist in front is on a bicycle made of material that does not reflect on the front radar
- The vehicle in front is detected late
- The vehicle in front is suddenly blocked by an obstacle

- The vehicle in front suddenly changes lane or suddenly reduces speed
- The vehicle in front is bent out of shape
- The front vehicle's speed is fast or slow
- The vehicle in front steers in the opposite direction of your vehicle to avoid a collision
- With a vehicle in front, your vehicle changes lane at low speed
- The vehicle in front is covered with snow
- You are departing or returning to the lane
- Unstable driving
- You are on a roundabout and the vehicle in front is not detected
- You are continuously driving in a circle
- The vehicle in front has an unusual shape
- The vehicle in front is driving uphill or downhill
- The pedestrian or cyclist is not fully detected, for example, if the pedestrian is leaning over or is not fully walking upright
- The pedestrian or cyclist is wearing clothing or equipment that makes it difficult to detect as a pedestrian or cyclist

Following image shows the image the sensor recognizes as vehicle, pedestrian and cyclist.



- The pedestrian or cyclist in front is moving very quickly
- The pedestrian or cyclist in front is short or is posing a low posture
- The pedestrian or cyclist in front has impaired mobility
- The pedestrian or cyclist in front is moving intersected with the driving direction
- There is a group of pedestrians, cyclists or a large crowd in front
- The pedestrian or cyclist is wearing clothing that easily blends into the background, making it difficult to detect
- The pedestrian or cyclist is difficult to distinguish from the similar shaped structure in the surroundings
- You are driving by a pedestrian, cyclist, traffic signs, structures, etc. near the intersection
- Driving in a parking lot
- Driving through a tollgate, construction area, unpaved road, partial paved road, uneven road, speed bumps, etc.
- Driving on an incline road, curved road, etc.

- Driving through a roadside with trees or streetlights
- The adverse road conditions cause excessive vehicle vibrations while driving
- Your vehicle height is low or high due to heavy loads, abnormal tire pressure, etc.
- Driving through a narrow road where trees or grass are overgrown
- There is interference by electromagnetic waves, such as driving in an area with strong radio waves or electrical noise

**⚠ WARNING**

- Driving on a curved road



Forward Collision-Avoidance Assist may not detect other vehicle, pedestrian or cyclist in front of you on curved roads adversely affecting the performance of the sensors. This may result in no warning or braking assist when necessary.

When driving on a curve, you must maintain a safe braking distance, and if necessary, steer the vehicle and depress the brake pedal to reduce your driving speed in order to maintain a safe distance.

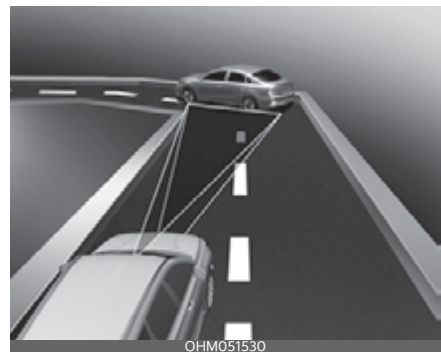

6

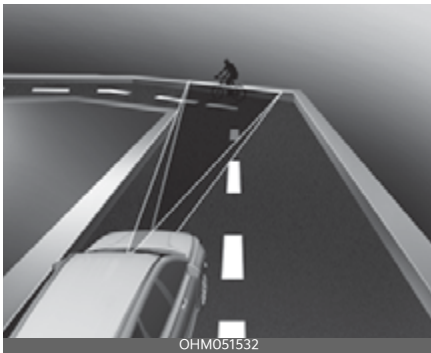
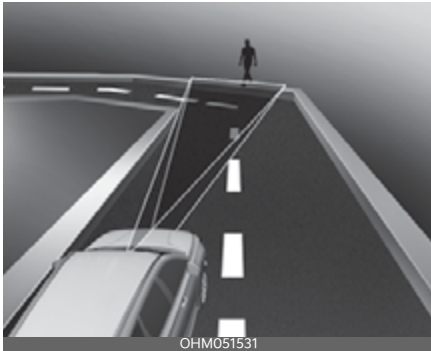

Forward Collision-Avoidance Assist may detect a vehicle, pedestrian or cyclist in the next lane or outside the lane when driving on a curved road. If this occurs, Forward Collision-Avoidance Assist may unnecessarily warn the driver and control the brake. Always check the traffic conditions around the vehicle.

- Driving on an inclined road



Forward Collision-Avoidance Assist may not detect other vehicle, pedestrian or cyclist in front of you while driving uphill or downhill adversely affecting the performance of the sensors.

This may result in unnecessary warning or braking assist when necessary. Also, vehicle speed may rapidly decrease when a vehicle, pedestrian or cyclist ahead is suddenly detected. Always have your eyes on the road while driving uphill or downhill and if necessary, steer your vehicle and depress the brake pedal to reduce your driving speed in order to maintain a safe distance.

- Changing lanes



[A]: Your vehicle  
[B]: Lane changing vehicle  
When a vehicle (B) moves into your lane from an adjacent lane, it cannot be detected by the sensor until it is in the sensor's detection range. Forward Collision-Avoidance Assist may not immediately detect the vehicle when the vehicle changes lanes abruptly. In this case, you must maintain a safe

braking distance, and if necessary, steer your vehicle and depress the brake pedal to reduce your driving speed in order to maintain a safe distance.



[A]: Your vehicle  
[B]: Lane changing vehicle  
[C]: Same lane vehicle  
When a vehicle (B) in front of you merges out of the lane, Forward Collision-Avoidance Assist may not immediately detect the vehicle (C) that is now in front of you. In this case, you must maintain a safe braking distance, and if necessary, steer your vehicle and depress the brake pedal to reduce your driving speed in order to maintain a safe distance.

- Detecting vehicle



If the vehicle in front of you has cargo that extends rearward from the cab, or when the vehicle in front of you has higher ground clearance, additional special attention is required. Forward Collision-Avoidance Assist may not be able to detect the cargo extending from the vehicle. In these instances, you must maintain a safe braking distance from the rearmost object, and if necessary, steer your vehicle and depress the brake pedal to reduce your driving speed in order to maintain distance.

### **⚠ WARNING**

- When you are towing a trailer or another vehicle, we recommend that Forward Collision-Avoidance Assist is turned off due to safety reasons.
- Forward Collision-Avoidance Assist may operate if objects that are similar in shape or characteristics to vehicle, pedestrian and cyclist are detected.
- Forward Collision-Avoidance Assist does not operate on bicycles, motorcycles, or smaller wheeled objects, such as luggage bags, shopping carts, or strollers that are dragged by a pedestrian or a cyclist.

- Forward Collision-Avoidance Assist
- may not operate normally if interfered with by strong electromagnetic waves.
- Forward Collision-Avoidance Assist may not operate for approximately 15 seconds after the vehicle is started, or the front view camera is initialized.

### **This device complies with Part 15 of the FCC rules.**

Operation is subject to the following three conditions:

1. This device may not cause harmful interference, and
2. This device must accept any interference received, including interference that may cause undesired operation.
3. Changes or modifications not expressly approved by the party responsible for compliance could void the user's authority to operate the device.

### **Radio frequency radiation exposure information:**

This equipment complies with FCC radiation exposure limits set forth for an uncontrolled environment. This equipment should be installed and operated with minimum distance of 8 in (20 cm) between the radiator (antenna) and your body. This transmitter must not be collocated or operating in conjunction with any other antenna or transmitter.

### **CAUTION TO USERS**

Changes or modifications not expressly approved by the party responsible for compliance could void the user's authority to operate the equipment.



## Lane Keeping Assist (LKA)



Lane Keeping Assist is designed to help detect lane markings while driving over a certain speed. Lane Keeping Assist will warn the driver if the vehicle leaves the lane without using the turn signal, or will automatically assist the driver's steering to help prevent the vehicle from departing the lane.

### Detecting sensor



[1]: Front view camera

The front view camera is used as a detecting sensor to detect lane markings.

Refer to the picture for the detailed location of the detecting sensor.

### CAUTION

For more details on the precautions of the front view camera, refer to "Forward Collision-Avoidance Assist (FCA) (Front view camera only)" on page 6-4.

### Lane Keeping Assist settings

#### Lane Safety

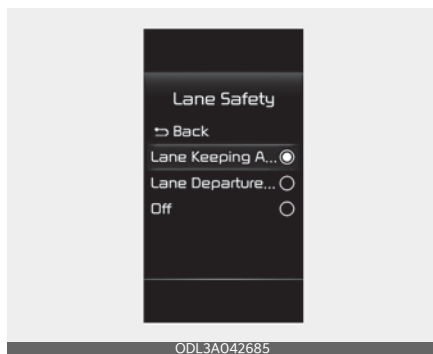

With the ENGINE START/STOP button in the ON position, select or deselect 'Driver Assistance → Lane Safety' from the Settings menu to set whether or not to use each function.

- If 'Lane Keeping Assist' is selected, Lane Keeping Assist will automatically assist the driver's steering when lane departure is detected to help prevent the vehicle from moving out of its lane.
- If 'Lane Departure Warning' is selected, Lane Keeping Assist will warn the driver with an audible warning when lane departure is detected. The driver must steer the vehicle.
- If 'Off' is selected, Lane Keeping Assist will turn off. The  indicator light will turn off on the cluster.



**⚠ WARNING**

- If 'Warning Only' is selected, steering is not assisted.
- Lane Keeping Assist does not control the steering wheel when the vehicle is driven in the middle of the lane.
- The driver should always be aware of the surroundings and steer the vehicle if 'Off' is selected.

**Turning Lane Keeping Assist On/Off**



With the ENGINE START/STOP button in the ON position, press the Lane Safety button located on the instrument panel to turn on Lane Keeping Assist. The  indicator light will appear on the cluster.

Press the button again to turn off the function.

**\* NOTICE**

- If the engine is restarted, Lane Keeping Assist will maintain the last setting.
- When Lane Keeping Assist is turned off with the Lane Safety button, Lane Safety settings will turn off.

**Warning Methods**



You can adjust the Warning Methods with the ignition switch or ENGINE START/ STOP button in the ON position.

- **Warning Volume** : Select 'User Settings → Driver Assistance → Warning Volume' on the instrument cluster or 'Settings → Vehicle → Driver Assistance → Warning Methods → Warning Volume' on the Infotainment system.
- **Driving Safety Priority** : Select 'Vehicle Settings → Driver Assistance → Warning Methods → Driving Safety Priority' on the Infotainment system. For safe driving, the audio volume will temporarily decrease to warn the driver with the audible warning.

## \* NOTICE

- Ensure that Warning Methods you have set may apply to the warning volume of other driver assistance systems.
- Warning Methods will maintain its last setting even if the vehicle is restarted.
- The setting menu may not be available for your vehicle depending on the vehicle features and specifications.
- Descriptions of each driver assistance system may be slightly different from the owner's manual after updating the software of your infotainment system. In this case, scan the QR code in the infotainment system manual to access the web manual to review the changes.
- Depending on your update, the menu may be displayed as 'Warning Sound' or 'Warning methods'.

## Lane Keeping Assist operation

### Warning and control

Lane Keeping Assist will warn and control the vehicle with Lane Departure Warning and Lane Keeping Assist.

#### Lane departure warning (left)

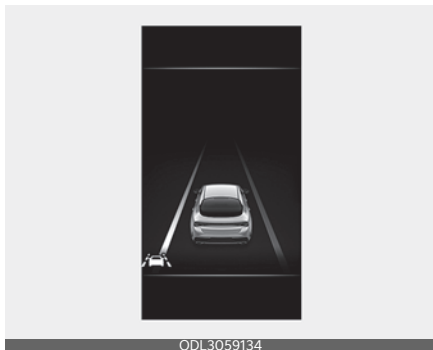

#### Lane departure warning (right)



## Lane Departure Warning

- To warn the driver that the vehicle is departing from the projected lane in front, the green  indicator light will blink on the cluster, the lane line will blink on the cluster depending on which direction the vehicle is veering, and an audible warning will sound.
- Lane Keeping Assist will operate when your driving speed is between approximately 40~120 mph (60~200 km/h).

## Lane Keeping Assist

- To warn the driver that the vehicle is departing from the projected lane in front, the green  indicator light will blink on the cluster, and the steering wheel will make adjustments to keep vehicle inside the lane.
- Lane Keeping Assist will operate when your driving speed is between approximately 40~120 mph (60~200 km/h).

## Hands-off warning

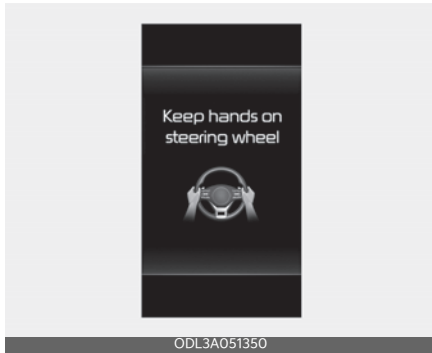

If the driver takes their hands off the steering wheel for several seconds, the 'Keep hands on the steering wheel' warning message will appear on the cluster, and an audible warning will sound in stages.

### **⚠ WARNING**

- The steering wheel may not be assisted if the steering wheel is held very tight or the steering wheel is steered over a certain degree.
- Lane Keeping Assist does not operate at all times. It is the responsibility of the driver to safely steer the vehicle and to maintain the vehicle in its lane.
- The hands-off warning message may appear late depending on road conditions. Always have your hands on the steering wheel while driving.
- If the steering wheel is held very lightly, the hands-off warning message may appear because Lane Keeping Assist may not recognize that the driver has their hands on the steering wheel.
- If you attach objects to the steering wheel, the hands-off warning may not work properly.

### **\* NOTICE**

- For more details on setting Lane Keeping Assist in the cluster system, refer to "LCD display modes" on page 4-69.
- When lane markings are detected, the lane lines on the cluster will change from gray to white and the green  indicator light will appear.

Lane undetected

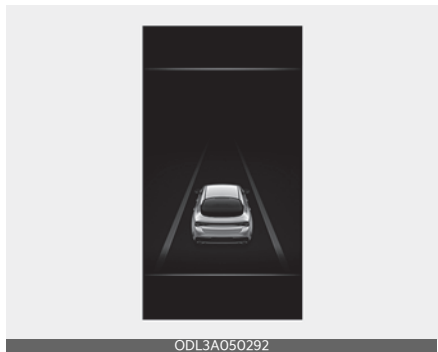

Lane detected

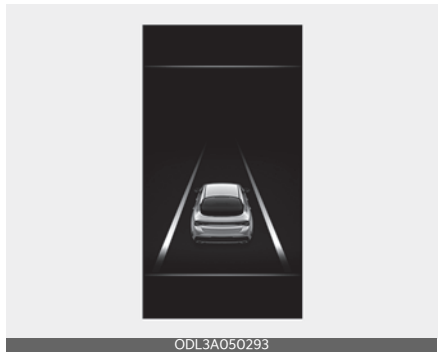



- Even though the steering is assisted by Lane Keeping Assist, the driver may control the steering wheel.
- The steering wheel may feel heavier or lighter when the steering wheel is

assisted by Lane Keeping Assist than when it is not.

## Lane Keeping Assist malfunction and limitations

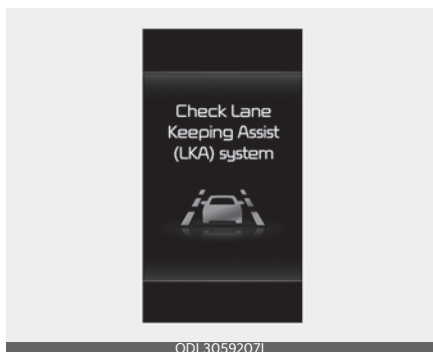
### Lane Keeping Assist malfunction



When Lane Keeping Assist is not working properly, the 'Check Lane Keeping Assist (LKA) system' warning message will appear and the amber  indicator light will appear on the cluster. If this occurs, have your vehicle inspected by an authorized Kia dealer.

### Limitations of Lane Keeping Assist

Lane Keeping Assist may not operate normally or may operate unexpectedly under the following circumstances:

- The lane is contaminated or difficult to distinguish because,
  - The lane markings is covered with rain, snow, dirt, oil, etc.
  - The color of the lane marking is not distinguishable from the road
  - There are markings on the road near the lane or the markings on the road looks similar to the lane markings

- The lane marking is indistinct or damaged
- The shadow is on the lane marking by a median strip, trees, guardrail, noise barriers, etc.
- There are more than two lane markings on the road
- The lane number increases or decreases, or the lane markings are crossing
- The lane markings are complicated or a structure substitutes for the lines, such as a construction area
- There are road markings, such as zig-zag lanes, crosswalk markings and road signs
- The lane suddenly disappears, such as at the intersection
- The lane (or road width) is very wide or narrow
- There is a road edge without a lane
- There is a boundary structure in the roadway, such as a tollgate, sidewalk, curb, etc.
- The distance to the front vehicle is extremely short or the vehicle in front is covering the lane marking

#### CAUTION

For more details on the limitations of the front view camera, refer to "Forward Collision-Avoidance Assist (FCA) (Front view camera only)" on page 6-4.

#### WARNING

Take the following precautions when using Lane Keeping Assist:

- The driver should hold the responsibility to safely drive and control the vehicle. Do not solely rely on Lane Keeping Assist and drive dangerously.

- The operation of Lane Keeping Assist can be canceled or not work properly depending on road conditions and surroundings. Always be cautious while driving.
  - Refer to "Limitations of Lane Keeping Assist" if the lane is not detected properly.
  - When you are towing a trailer or another vehicle, we recommend that Lane Keeping Assist is turned off due to safety reasons.
  - If the vehicle is driven at high speed, the steering wheel will not be controlled. The driver must always follow the speed limit when using Lane Keeping Assist.
  - If any other function's warning message is displayed or audible warning is generated, Blind-Spot Collision-Avoidance Assist's warning message may not be displayed and an audible warning may not be generated.
  - You may not hear the warning sound of Lane Keeping Assist if the surrounding is noisy.
  - If you attach objects to the steering wheel, steering may not be assisted properly.
  - Lane Keeping Assist may not operate for approximately 15 seconds after the vehicle is started, or the front view camera is initialized.
  - Lane Keeping Assist will not operate when:
    - The turn signal or hazard warning flasher is turned on
    - The vehicle is not driven in the center of the lane when Lane Keeping Assist is turned on or right after changing a lane
- 
- ESC (Electronic Stability Control) or VSM (Vehicle Stability Management) is activated
  - The vehicle is driven on a sharp curve
  - Vehicle speed is below 35 mph (55 km/h) or above 130 mph (210 km/h)
  - The vehicle makes sharp lane changes
  - The vehicle brakes suddenly

## Blind-Spot Collision-Avoidance Assist (BCA) (if equipped)

Blind-Spot Collision-Avoidance Assist is designed to help detect and monitor approaching vehicles in the driver's blind spot area and warn the driver of a possible collision with a warning message and audible warning.

In addition, if there is a risk of collision when changing lanes, Blind-Spot Collision-Avoidance Assist can help avoid collision by applying the brake.

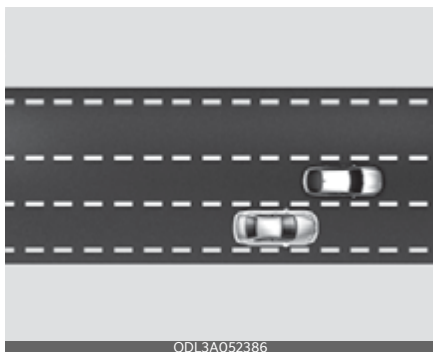

Blind-Spot Collision-Avoidance Assist will help detect and inform the driver that a vehicle is in the blind spot.

### ⚠ CAUTION

The detecting range may vary depending on the speed of your vehicle. However, even if there is a vehicle in the blind spot, Blind-Spot Collision-Avoidance Assist may not warn you when you pass by at high speeds.

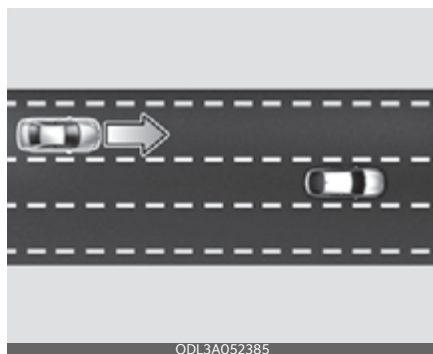

Blind-Spot Collision-Avoidance Assist help detect and informs the driver that a vehicle is approaching at high speed from the blind spot area.

### ⚠ CAUTION

Warning timing may vary depending on the speed of the vehicle approaching at high speed.

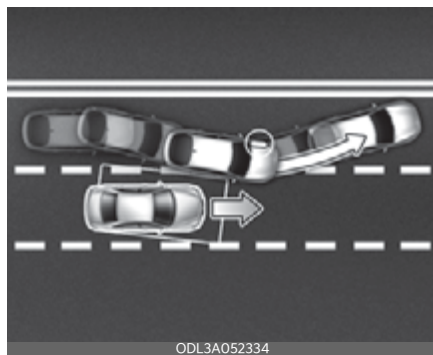

When changing lanes by detecting the lane ahead, if Blind-Spot Collision-Avoidance Assist judges that there is a collision risk with an approaching vehicle in the blind spot, it can help avoid collision by applying the brake.

## Detecting sensor



[1]: Front view camera [2]: Rear corner radar

Refer to the picture for the detailed location of the detecting sensors.

### **⚠ CAUTION**

Take the following precautions to maintain optimal performance of the detecting sensor:

- Never disassemble the rear corner radar or radar assembly, or apply any impact on it.
- If there is impact on the rear corner radar or near the radar, even though the warning message does not appear on the cluster, Blind-Spot Collision-Avoidance Assist may not operate properly. In this case, have your vehi-

cle inspected by an authorized Kia dealer.

- If the rear corner radars have been replaced or repaired, have your vehicle inspected by an authorized Kia dealer.
- Use only genuine parts to repair or replace a damaged front radar cover. Do not apply paint to the front radar cover.
- Do not apply license plate frame or objects, such as a bumper sticker, film or a bumper guard near the rear corner radar.
- Blind-Spot Collision-Avoidance Assist may not work properly if the bumper has been replaced, or the surroundings of the rear corner radar has been damaged or paint has been applied.
- If a trailer, carrier, etc. is installed, it may adversely affect the performance of the rear corner radar or Blind-Spot Collision-Avoidance Assist may not operate.

### **⚠ CAUTION**

For more details on the precautions of the front view camera, refer to "Forward Collision-Avoidance Assist (FCA) (Front view camera only)" on page 6-4.

## Blind-Spot Collision-Avoidance Assist settings

### Blind-Spot Safety

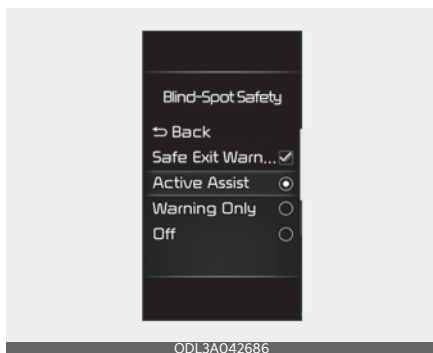

With the ENGINE START/STOP button in the ON position, select or deselect 'Driver Assistance → Blind-Spot Safety' from the Settings menu to set whether or not to use each function.

- If 'Active Assist' is selected, Blind-Spot Collision-Avoidance Assist will warn the driver with a warning message, an audible warning, and braking assist will be applied depending on the collision risk levels.
- If 'Warning Only' is selected, Blind-Spot Collision-Avoidance Assist will warn the driver with a warning message, and an audible warning depending on the collision risk levels. Braking will not be assisted.
- If 'Off' is selected, Blind-Spot Collision-Avoidance Assist will turn off.

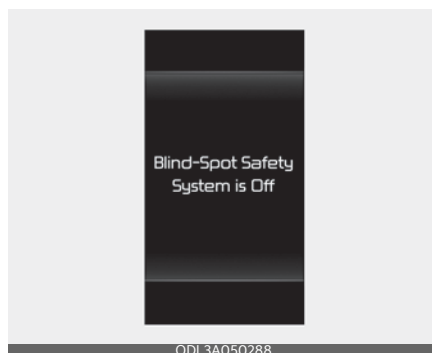

When the engine is restarted with Blind-Spot Collision-Avoidance Assist off, the 'Blind-Spot Safety System is Off' message will appear on the cluster.

If you change the setting from 'Off' to 'Active Assist' or 'Warning Only', the warning light on the side view mirror will blink for approximately 3 seconds.

In addition, if the engine is turned on, when Blind-Spot Collision-Avoidance Assist is set to 'Active Assist' or 'Warning Only', the warning light on the side view mirror will blink for approximately 3 seconds.

#### **⚠ WARNING**

- If 'Warning Only' is selected, braking is not assisted.
- If 'Off' is selected, the driver should always be aware of the surroundings and drive safely.

#### **\* NOTICE**

If the engine is restarted, Blind-Spot Collision-Avoidance Assist will maintain the last setting.



## Warning Timing

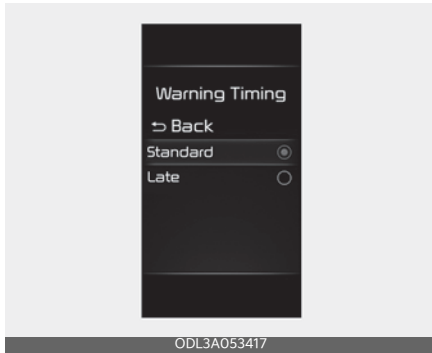

With the ENGINE START/STOP button in the ON position, select 'Driver Assistance → Warning Timing' from the Settings menu to change the initial warning activation time for Blind-Spot Collision-Avoidance Assist.

When the vehicle is first delivered, Warning Timing is set to 'Standard'. If you change the Warning Timing, the warning time of other Driver Assistance systems may change.

### **CAUTION**

- The setting of the Warning Timing applies to all functions of Blind-Spot Collision-Avoidance Assist.
- Even though 'Standard' is selected for Warning Timing, if the vehicles approaches at high speed, the initial warning activation time may seem late.
- Select 'Late' for Warning Timing when traffic is light and when driving speed is slow.

## Warning Methods

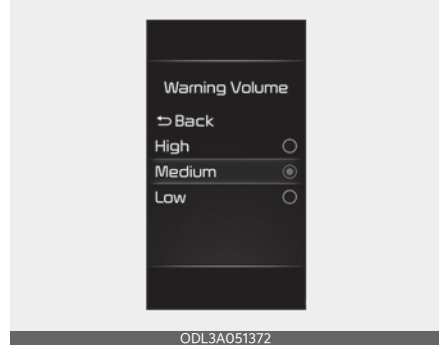
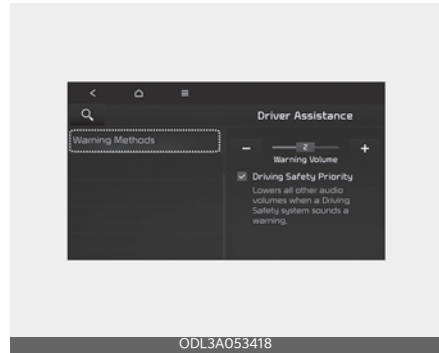

You can adjust the Warning Methods with the ignition switch or ENGINE START/ STOP button in the ON position.

- Warning Volume : Select 'User Settings → Driver Assistance → Warning Volume' on the instrument cluster or 'Settings → Vehicle → Driver Assistance → Warning Methods → Warning Volume' on the Infotainment system.
- Driving Safety Priority : Select 'Vehicle Settings → Driver Assistance → Warning Methods → Driving Safety Priority' on the Infotainment system. For safe driving, the audio volume will temporarily decrease to warn the driver with the audible warning.

## \* NOTICE

- Ensure that Warning Methods you have set may apply to the warning volume of other driver assistance systems.
- Warning Methods will maintain its last setting even if the vehicle is restarted.
- The setting menu may not be available for your vehicle depending on the vehicle features and specifications.
- Descriptions of each driver assistance system may be slightly different from the owner's manual after updating the software of your infotainment system. In this case, scan the QR code in the infotainment system manual to access the web manual to review the changes.
- Depending on your update, the menu may be displayed as 'Warning Sound' or 'Warning methods'.

## Blind-Spot Collision-Avoidance Assist operation

### Warning and control

#### Vehicle detection

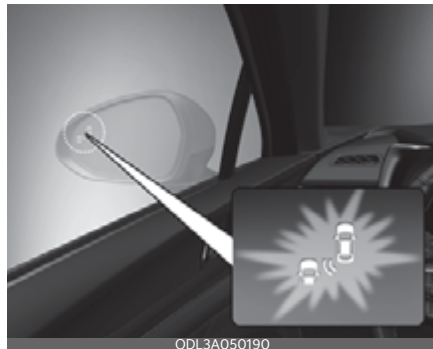

- To warn the driver a vehicle is detected, the warning light on the side view mirror and head-up display (if equipped) will appear.
- Blind-Spot Collision-Avoidance Assist will operate when your driving speed is above 12 mph (20 km/h) and the speed of the vehicle in the blind spot area is above 7 mph (10 km/h).

#### Collision Warning

- Collision warning will operate when the turn signal is turned on in the direction of the detected vehicle.
- If 'Warning Only' is selected from the Settings menu, the collision warning will operate when your vehicle approaches the lane the blind spot vehicle is detected.
- To warn the driver of a collision, the warning light on the side view mirror and head-up display (if equipped) will blink. At the same time, an audible warning will sound.

- When the turn signal is turned off, the collision warning will be canceled and Blind-Spot Collision-Avoidance Assist will return to vehicle detection state.
- A vehicle is detected in the following conditions.
  - Your driving speed: Above 25 mph (40 km/h)
  - The speed of the vehicle in your blind spot area: Above 7 mph (10 km/h)

### **⚠ WARNING**

- The detecting range of the rear corner radar is determined by a standard road width, therefore, on a narrow road, Blind-Spot Collision-Avoidance Assist may detect other vehicles in the next lane and warn you.
- In contrast, on a wide road, Blind-Spot Collision-Avoidance Assist may not be able to detect a vehicle driving in the next lane and may not warn you.
- When the hazard warning flasher is on, the collision warning by the turn signal will not operate.

### **\* NOTICE**

If the driver's seat is on the left side, the collision warning may occur when you turn left. Maintain a proper distance with the vehicles in the left lane. If the driver's seat is on the right side, the collision warning may occur when you turn right. Maintain a proper distance with the vehicles in the right lane.

## Collision-Avoidance Assist (while driving)



- To warn the driver of a collision, the warning light on the side view mirror will blink and a warning message will appear on the cluster. At the same time, an audible warning will sound, warning light on the head-up display will blink.
- Blind-Spot Collision-Avoidance Assist will operate when your driving speed is between 40~120 mph (60~200 km/h) and both lane markings of the driving lane are detected.
- Emergency braking will be assisted to help prevent collision with the vehicle in the blind spot area.

### **⚠ WARNING**

- Collision-Avoidance Assist will be canceled under the following circumstances:
  - Your vehicle enters the next lane by a certain distance
  - Your vehicle is away from the collision risk
  - The steering wheel is sharply steered
  - The brake pedal is depressed

- Forward Collision-Avoidance Assist is operating
- After Blind-Spot Collision-Avoidance Assist operation or changing lane, you must drive to the center of the lane. Blind-Spot Collision-Avoidance Assist will not operate if the vehicle is not driven in the center of the lane.

### WARNING

Take the following precautions when using Blind-Spot Collision-Avoidance Assist:

- For your safety, change the Settings after parking the vehicle at a safe location.
- If any other function's warning message is displayed or audible warning is generated, Blind-Spot Collision-Avoidance Assist's warning message may not be displayed and audible warning may not be generated.
- You may not hear the warning sound of Blind-Spot Collision-Avoidance Assist if the surrounding is noisy.
- Blind-Spot Collision-Avoidance Assist may not operate if the driver applies the brake pedal to avoid collision.
- When Blind-Spot Collision-Avoidance Assist is operating, braking control by the function will automatically cancel when the driver excessively depresses the accelerator pedal or sharply steers the vehicle.
- During Blind-Spot Collision-Avoidance Assist operation, the vehicle may stop suddenly injuring passengers and shifting loose objects. Always have the seat belt on and keep loose objects secured.
- Even if there is a problem with Blind-Spot Collision-Avoidance Assist, the

vehicle's basic braking performance will operate normally.

- Blind-Spot Collision-Avoidance Assist does not operate in all situations or cannot avoid all collisions.
- Blind-Spot Collision-Avoidance Assist may warn the driver late or may not warn the driver depending on the road and driving conditions.
- Driver should maintain control of the vehicle at all times. Do not depend on Blind-Spot Collision-Avoidance Assist. Maintain a safe braking distance, and if necessary, depress the brake pedal to reduce driving speed or to stop the vehicle.
- Never operate Blind-Spot Collision-Avoidance Assist on people, animal, objects, etc. It may cause serious injury or death.

### WARNING

The brake control may not operate properly depending on the status of ESC (Electronic Stability Control).

There will only be a warning when:

- The ESC (Electronic Stability Control) warning light is on
- ESC (Electronic Stability Control) is engaged in a different function

## Blind-Spot Collision-Avoidance Assist malfunction and limitations

### Blind-Spot Collision-Avoidance Assist malfunction

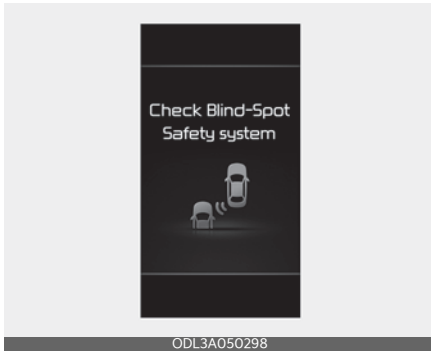

When Blind-Spot Collision-Avoidance Assist is not working properly, the 'Check Blind-Spot Safety system' warning message will appear on the cluster, and Blind-Spot Collision-Avoidance Assist will turn off automatically or Blind-Spot Collision-Avoidance Assist will be limited. In this case, have your vehicle inspected by an authorized Kia dealer.

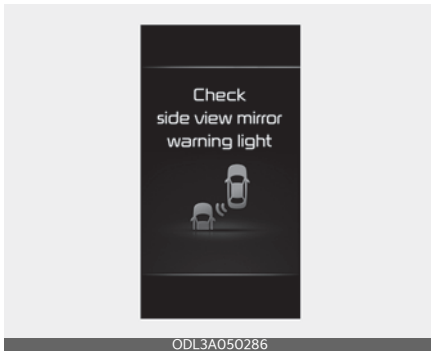

When the side view mirror warning light is not working properly, the 'Check side view mirror warning light' warning message will appear on the cluster. In this

case, have your vehicle inspected by an authorized Kia dealer.

### Blind-Spot Collision-Avoidance Assist disabled

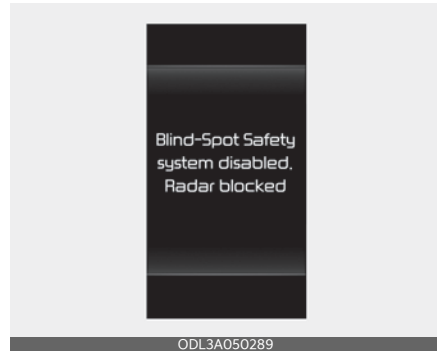

When the rear bumper around the rear corner radar or sensor is covered with foreign material, such as snow or rain, or installing a trailer or carrier, it can reduce the detecting performance and temporarily limit or disable Blind-Spot Collision-Avoidance Assist.

If this occurs, the 'Blind-Spot Safety system disabled. Radar blocked' warning message will appear on the cluster.

Blind-Spot Collision-Avoidance Assist will operate normally when such foreign material or trailer, etc. is removed, and then the engine is restarted.

If Blind-Spot Collision-Avoidance Assist does not operate normally after it is removed, have your vehicle inspected by an authorized Kia dealer.

#### **WARNING**

- Even though the warning message does not appear on the cluster, Blind-Spot Collision-Avoidance Assist may not properly operate.
- Blind-Spot Collision-Avoidance Assist may not properly operate in an area

(e.g. open terrain) where any substance are not detected right after the engine is turned on, or when the detecting sensor is blocked with foreign material right after the engine is turned on.

### CAUTION

Turn off Blind-Spot Collision-Avoidance Assist to install a trailer, carrier, etc., or remove the trailer, carrier, etc. to use Blind-Spot Collision-Avoidance Assist.

### Limitations of Blind-Spot Collision-Avoidance Assist

Blind-Spot Collision-Avoidance Assist may not operate normally, or it may operate unexpectedly under the following circumstances:

- There is inclement weather, such as heavy snow, heavy rain, etc.
- The rear corner radar is covered with snow, rain, dirt, etc.
- The temperature around the rear corner radar is high or low
- Driving on a highway (or motorway) ramp
- The road pavement (or the peripheral ground) abnormally contains metallic components (i.e. possibly due to subway construction).
- There is a fixed object near the vehicle, such as sound barriers, guardrails, central dividers, entry barriers, street lamps, signs, tunnels, walls, etc. (including double structures)
- Driving in large areas where there are few vehicles or structures (i.e. desert, meadow, suburb, etc.)
- Driving through a narrow road where trees or grass are overgrown

- Driving on a wet road surface, such as a puddle on the road
- The other vehicle drives very close behind your vehicle, or the other vehicle passes by your vehicle in close proximity
- The speed of the other vehicle is very fast that it passes by your vehicle in a short time
- Your vehicle passes by the other vehicle
- Your vehicle changes lane
- Your vehicle has started at the same time as the vehicle next to you and has accelerated
- The vehicle in the next lane moves two lanes away from you, or when the vehicle two lanes away moves to the next lane from you
- A trailer or carrier is installed around the rear corner radar
- The bumper around the rear corner radar is covered with objects, such as a bumper sticker, bumper guard, bike rack, etc.
- The bumper around the rear corner radar is impacted, damaged or the radar is out of position
- Your vehicle height is low or high due to heavy loads, abnormal tire pressure, etc.

Blind-Spot Collision-Avoidance Assist may not operate normally, or it may operate unexpectedly when the following objects are detected:

- A motorcycle or bicycle is detected
- A vehicle such as a flat trailer is detected
- A big vehicle such as a bus or truck is detected

- A moving obstacle such as a pedestrian, animal, shopping cart or a baby stroller is detected
- A vehicle with low height such as a sports car is detected

Braking control may not work, driver's attention is required in the following circumstances:

- The vehicle severely vibrates while driving over a bumpy road, uneven road or concrete patch
- Driving on a slippery surface due to snow, water puddle, ice, etc.
- The tire pressure is low or a tire is damaged
- The brake is reworked
- The vehicle makes abrupt lane changes

**⚠ CAUTION**

For more details on the limitations of the front view camera, refer to "Forward Collision-Avoidance Assist (FCA) (Front view camera only)" on page 6-4.

**⚠ WARNING**

- Driving on a curved road



Blind-Spot Collision-Avoidance Assist may not operate properly when driving on a curved road. Blind-Spot Colli-

sion-Avoidance Assist may not detect the vehicle in the next lane. Always pay attention to road and driving conditions while driving.



Blind-Spot Collision-Avoidance Assist may not operate properly when driving on a curved road. The function may not recognize a vehicle in the same lane.

Always pay attention to road and driving conditions while driving.

- Driving where the road is merging/dividing

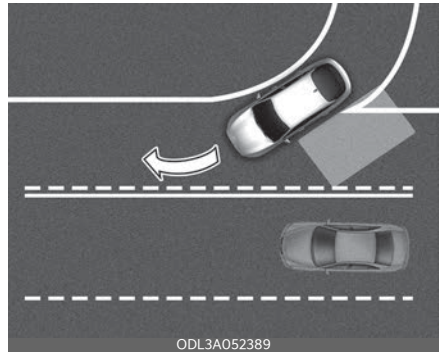

Blind-Spot Collision-Avoidance Assist may not operate properly when driving where the road merges or divides. Blind-Spot Collision-Avoidance Assist may not detect the vehicle in the next lane.

Always pay attention to road and driving conditions while driving.

- Driving on an inclined road

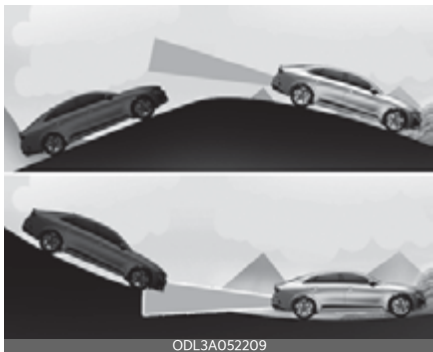

Blind-Spot Collision-Avoidance Assist may not operate properly when driving on a slope. Blind-Spot Collision-Avoidance Assist may not detect the vehicle in the next lane or may incorrectly detect the ground or structure. Always pay attention to road and driving conditions while driving.

- Driving where the heights of the lanes are different

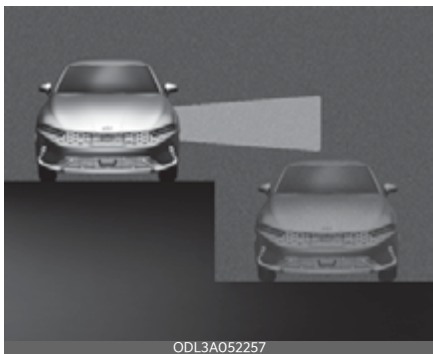

Blind-Spot Collision-Avoidance Assist may not operate properly when driving where the heights of the lanes are different. Blind-Spot Collision-Avoidance Assist may not detect the vehicle on a road with different lane heights

(underpass joining section, grade separated intersections, etc.).

Always pay attention to road and driving conditions while driving.

**⚠ WARNING**

- When you are towing a trailer or another vehicle, make sure that you turn off Blind-Spot Collision-Avoidance Assist.
- Blind-Spot Collision-Avoidance Assist may not operate normally if interfered by strong electromagnetic waves.
- Blind-Spot Collision-Avoidance Assist may not operate for approximately 15 seconds after the vehicle is started, or the front view camera or rear corner radars are initialized.

**This device complies with Part 15 of the FCC rules.**

Operation is subject to the following two conditions:

1. This device may not cause harmful interference, and
2. This device must accept any interference received, including interference that may cause undesired operation.

**CAUTION TO USERS**

Changes or modifications not expressly approved by the party responsible for compliance could void the user's authority to operate the equipment.



## Safe Exit Warning (SEW) (if equipped)

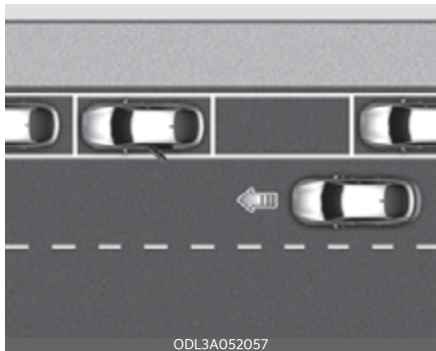

After the vehicle stops, when an approaching vehicle from the rear area is detected as soon as a passenger opens a door, Safe Exit Warning will warn the driver with a warning message and an audible warning to help prevent a collision.

### **⚠ CAUTION**

The timing of the warning may vary depending on the speed of the approaching vehicle.

## Detecting sensor



[1] : Rear corner radar

Refer to the picture for the detailed location of the detecting sensor.

### **\* NOTICE**

For more details on the precautions of the rear corner radars, refer to "Blind-Spot Collision-Avoidance Assist (BCA) (if equipped)" on page 6-37.

## Safe Exit Warning settings

### Safe Exit Warning

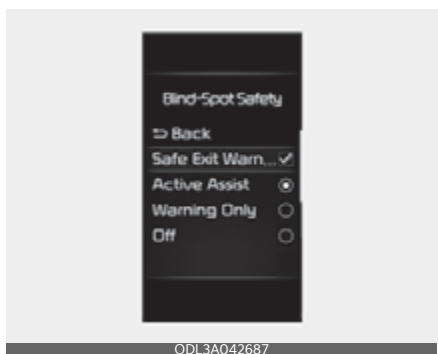

With the ENGINE START/STOP button in the ON position, and select 'Driver Assistance → Blind-Spot Safety → Safe Exit Warning' to turn on Safe Exit Warning and deselect to turn off.

### **⚠ WARNING**

If 'Safe Exit Warning' is deselected, the function cannot assist you.

### **\* NOTICE**

If the engine is restarted, Safe Exit Warning will maintain the last setting.

## Warning Methods

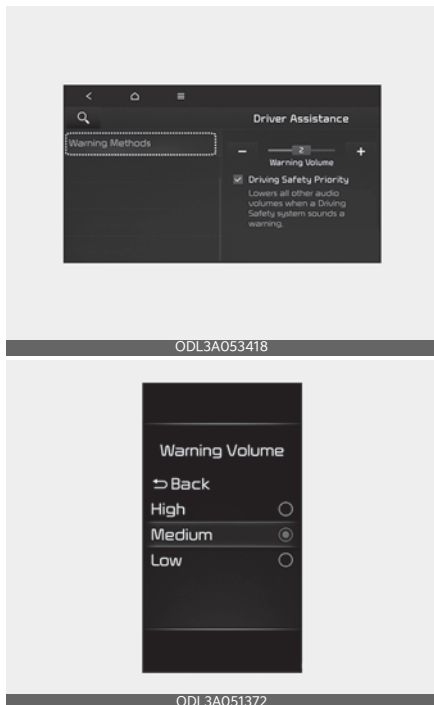

You can adjust the Warning Methods with the ignition switch or ENGINE START/ STOP button in the ON position.

- **Warning Volume :** Select 'User Settings → Driver Assistance → Warning Volume' on the instrument cluster or 'Settings → Vehicle → Driver Assistance → Warning Methods → Warning Volume' on the Infotainment system.
- **Driving Safety Priority :** Select 'Vehicle Settings → Driver Assistance → Warning Methods → Driving Safety Priority' on the Infotainment system. For safe driving, the audio volume will temporarily decrease to warn the driver with the audible warning.

### \* NOTICE

- Ensure that Warning Methods you have set may apply to the warning volume of other driver assistance systems.
- Warning Methods will maintain its last setting even if the vehicle is restarted.
- The setting menu may not be available for your vehicle depending on the vehicle features and specifications.
- Descriptions of each driver assistance system may be slightly different from the owner's manual after updating the software of your infotainment system. In this case, scan the QR code in the infotainment system manual to access the web manual to review the changes.
- Depending on your update, the menu may be displayed as 'Warning Sound' or 'Warning methods'.

6

## Safe Exit Warning operation

### Warning

#### Collision warning when exiting vehicle

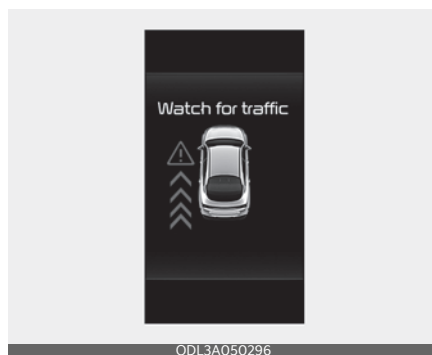

- When an approaching vehicle from the rear is detected at the moment a door is opened, the 'Watch for traffic' warning message will appear on the cluster, and an audible warning will sound.
- Safe Exit Warning will warn the driver when your driving speed is below 2 mph (3 km/h), and the speed of the approaching vehicle from the rear is above 4 mph (6 km/h).

### **⚠ WARNING**

- For your safety, change the Settings after parking the vehicle at a safe location.
- If any other function's warning message is displayed or audible warning is generated, Safe Exit Warning message may not be displayed and audible warning may not be generated.
- You may not hear the warning sound of Safe Exit Warning if the surrounding is noisy.
- Safe Exit Warning does not operate in all situations or cannot prevent all collisions.
- Safe Exit Warning may warn the driver late or may not warn the driver depending on the road and driving conditions. Always check vehicle surroundings.
- Safe Exit Warning does not operate if there is a problem with Blind-Spot Collision-Avoidance Assist.
- The warning message of Blind-Spot Collision-Avoidance Assist will appear on the cluster when:
  - Blind-Spot Collision-Avoidance Assist sensor or the sensor surrounding is polluted or covered

- Blind-Spot Collision-Avoidance Assist fails to warn passengers or prematurely warn passengers

### **\* NOTICE**

After the engine is turned off, Safe Exit Warning operates approximately for 3 minutes, but turns off immediately if the doors are locked.

## **Safe Exit Warning malfunction and limitations**

### **Safe Exit Warning malfunction**

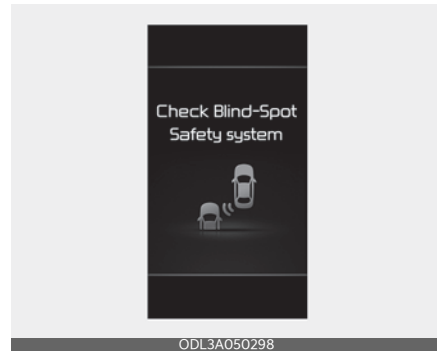

When Safe Exit Warning is not working properly, the 'Check Blind-Spot Safety system' warning message will appear on the cluster, and Safe Exit Warning will turn off automatically or Safe Exit Warning will be limited. In this case, have your vehicle inspected by an authorized Kia dealer.

## Safe Exit Warning disabled

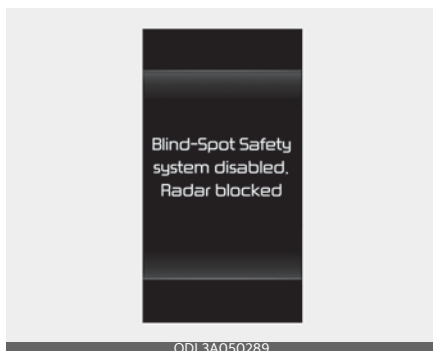

When the rear bumper around the rear-side radar or sensor is covered with foreign matters, such as snow or rain, or installing a trailer or carrier, it can reduce the detecting performance and temporarily limit or disable Safe Exit Warning. If this occurs, the 'Blind-Spot Safety system disabled. Radar blocked' warning message will appear on the cluster.

Safe Exit Warning will operate normally when such foreign matters or trailer, etc. is removed. Always keep it clean.

If Safe Exit Warning does not operate normally after it is removed, have your vehicle inspected by an authorized Kia dealer.

### **⚠ WARNING**

- Even though the warning message does not appear on the cluster, Safe Exit Warning may not properly operate.
- Safe Exit Warning may not properly operate in an area (e.g., open terrain), where any substance are not detected after turning ON the engine.

### **⚠ CAUTION**

Turn off Safe Exit Warning to install a trailer, carrier, etc., or remove the trailer, carrier, etc. to use Safe Exit Warning.

### **Limitations of Safe Exit Warning**

Safe Exit Warning may not operate normally, or it may operate unexpectedly under the following circumstances:

- Getting out of the vehicle where trees or grass are overgrown.
- Getting out of the vehicle where the road is wet.
- The approaching vehicle is very fast or very slow.

### **⚠ CAUTION**

For more details on the limitations of the rear corner radar, refer to "Blind-Spot Collision-Avoidance Assist (BCA) (if equipped)" on page 6-37.

### **⚠ WARNING**

- Safe Exit Warning may not operate normally if interfered by strong electromagnetic waves.
- Safe Exit Warning may not operate for 3 seconds after the vehicle is started, or the rear corner radars are initialized.

## Safe Exit Assist (SEA) (if equipped)

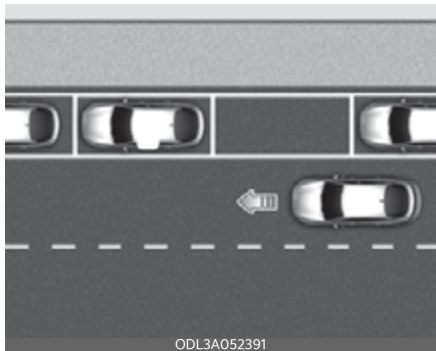

After the vehicle stops, when an approaching vehicle from the rear area is detected as soon as a passenger opens a door, Safe Exit Assist will warn the driver with a warning message and an audible warning to help prevent a collision.



In addition, when the electronic child safety lock button is in the LOCK position and an approaching vehicle from the rear area is detected, the electronic child safety lock button will not unlock even if the driver presses the button to prevent the rear doors from opening.

### **⚠ CAUTION**

The timing of the warning may vary depending on the speed of the approaching vehicle.

### Detecting sensor



[1] : Rear corner radar

Refer to the picture for the detailed location of the detecting sensor.

### **\* NOTICE**

For more details on the precautions of the rear corner radars, refer to "Blind-Spot Collision-Avoidance Assist (BCA) (if equipped)" on page 6-37.

## Safe Exit Assist settings

### Safe Exit Assist

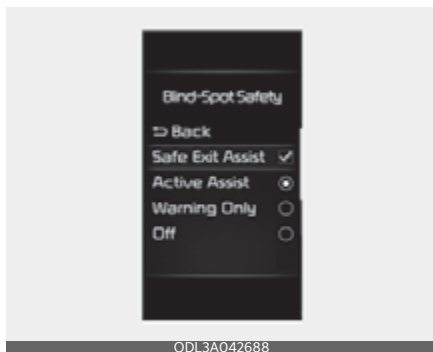

With the ENGINE START/STOP button in the ON position, select 'Driver Assistance → Blind-Spot Safety → Safe Exit Assist' from the Settings menu to turn on Safe Exit Assist and deselect to turn off the function.

#### **⚠ WARNING**

The driver should always be aware that unexpected and sudden situations may occur. If 'Safe Exit Assist' is deselected, the function cannot assist you.

#### **\* NOTICE**

If the engine is restarted, Safe Exit Assist will maintain the last setting.

## Warning Methods

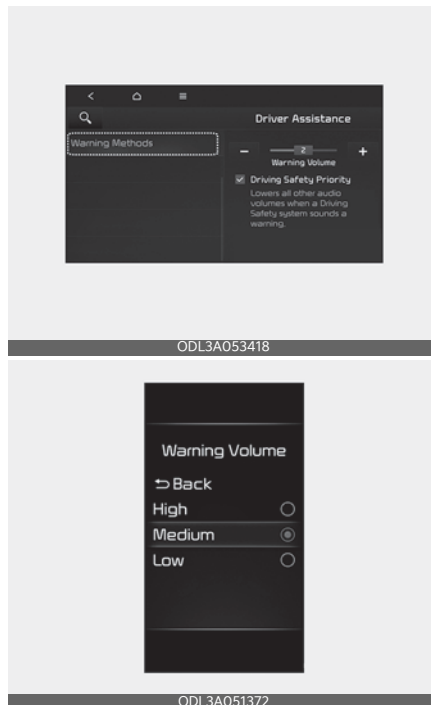

You can adjust the Warning Methods with the ignition switch or ENGINE START/ STOP button in the ON position.

- **Warning Volume** : Select 'User Settings → Driver Assistance → Warning Volume' on the instrument cluster or 'Settings → Vehicle → Driver Assistance → Warning Methods → Warning Volume' on the Infotainment system.
- **Driving Safety Priority** : Select 'Vehicle Settings → Driver Assistance → Warning Methods → Driving Safety Priority' on the Infotainment system. For safe driving, the audio volume will temporarily decrease to warn the driver with the audible warning.

## \* NOTICE

- Ensure that Warning Methods you have set may apply to the warning volume of other driver assistance systems.
- Warning Methods will maintain its last setting even if the vehicle is restarted.
- The setting menu may not be available for your vehicle depending on the vehicle features and specifications.
- Descriptions of each driver assistance system may be slightly different from the owner's manual after updating the software of your infotainment system. In this case, scan the QR code in the infotainment system manual to access the web manual to review the changes.
- Depending on your update, the menu may be displayed as 'Warning Sound' or 'Warning methods'.

- When an approaching vehicle from the rear is detected at the moment a door is opened, the 'Watch for traffic' warning message will appear on the cluster, and an audible warning will sound.
- Safe Exit Assist will warn the driver when your driving speed is below 2 mph (3 km/h), and the speed of the approaching vehicle from the rear is above 4 mph (6 km/h).

## Safe Exit Assist linked with Electronic child safety lock



ODL3A050297

## Safe Exit Assist operation

### Warning and control

### Collision warning when exiting vehicle



ODL3A050296

- When Electric child safety lock is operating and an approaching vehicle from the rear area is detected, the rear doors cannot be unlocked even if the driver tries to unlock the rear doors using the electronic child safety lock button. The 'Check surroundings then try again' warning message will appear on the cluster.
- Safe Exit Assist will warn the driver when vehicle speed is below 2 mph (3 km/h) and the speed of the approaching vehicle from the rear is above 4 mph (6 km/h).
- For more details on electric child safety lock button, refer to "Electronic

child safety lock system (if equipped)" on page 4-21.

### WARNING

If the driver presses the electronic child lock button again approximately within 10 seconds after the warning message appears, Safe Exit Assist judges that the driver has unlocked the doors acknowledging the rear status. The electronic child safety lock will turn off (button indicator OFF) and the rear doors will unlock. Always check the surroundings before turning off the electronic child safety lock button.

### NOTICE

If opening the rear doors from outside, they will be opened regardless of Safe Exit Assist.

### WARNING

Take the following precautions when using Safe Exit Assist:

- For your safety, change the Settings after parking the vehicle at a safe location.
- If any other function's warning message is displayed or audible warning is generated, Safe Exit Assist warning message may not be displayed and audible warning may not be generated.
- You may not hear the warning sound of Safe Exit Assist if the surrounding is noisy.
- Safe Exit Assist does not operate in all situations or cannot prevent all collisions.
- Safe Exit Assist may warn the driver late or may not warn the driver depending on the road and driving

conditions. Always check vehicle surroundings.

- The driver and passengers are responsible for accidents that occurs while exiting the vehicle. Always check the surroundings before you exit the vehicle.
- Never deliberately operate Safe Exit Assist. Doing so may lead to serious injury or death.
- Safe Exit Assist does not operate if there is a problem with Blind-Spot Collision-Avoidance Assist.
  - The warning message of Blind-Spot Collision-Avoidance Assist will not appear if:
    - Blind-Spot Collision-Avoidance Assist sensor or the sensor surrounding is polluted or covered
    - Blind-Spot Collision-Avoidance Assist fails to warn passengers or falsely warn passengers

### NOTICE

After the engine is turned off, Safe Exit Assist operates approximately for 10 minutes, but turns off immediately if the doors are locked.



## Safe Exit Assist malfunction and limitations

### Safe Exit Assist malfunction



When Safe Exit Assist is not working properly, the 'Check Blind-Spot Safety system' warning message will appear on the cluster, and Safe Exit Assist will turn off automatically or it will be limited. In this case, have your vehicle inspected by an authorized Kia dealer.

### Safe Exit Assist disabled

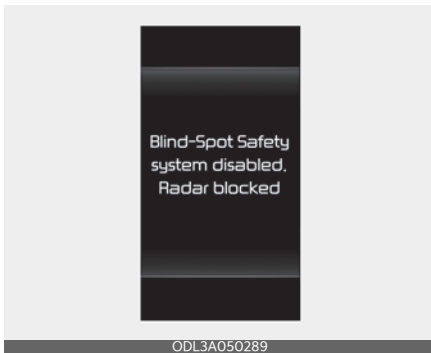

When the rear bumper around the rear-side radar or sensor is covered with foreign matters, such as snow or rain, or installing a trailer or carrier, it can reduce the detecting performance and temporarily limit or disable Safe Exit Assist.

If this occurs, the 'Blind-Spot Safety system disabled. Radar blocked' warning message will appear on the cluster.

Safe Exit Assist will operate normally when such foreign matters or trailer, etc. is removed. Always keep it clean.

If Safe Exit Assist does not operate normally after it is removed, have your vehicle inspected by an authorized Kia dealer.

#### ⚠ WARNING

- Even though the warning message does not appear on the cluster, Safe Exit Assist may not properly operate.
- Safe Exit Assist may not properly operate in an area (e.g., open terrain), where any substance are not detected after turning ON the engine.

#### ⚠ CAUTION

Turn off Safe Exit Assist to install a trailer, carrier, etc., or remove the trailer, carrier, etc. to use Safe Exit Assist.

### Limitations of Safe Exit Assist

Safe Exit Assist may not operate normally, or it may operate unexpectedly under the following circumstances:

- Driving through a narrow road where trees are grass are overgrown
- Driving on a wet road surface, such as a puddle in the road
- The speed of the other vehicle is very fast or slow

#### \* NOTICE

For more details on the precautions of the rear corner radars, refer to "Blind-Spot Collision-Avoidance Assist (BCA) (if equipped)" on page 6-37.

**⚠ WARNING**

- Safe Exit Assist may not operate normally if interfered by strong electromagnetic waves.
- Safe Exit Assist may not operate for approximately 3 seconds after the vehicle is started, or the rear corner radars are initialized.

**Driver Attention Warning (DAW)****Basic function**

Driver Attention Warning will help determine the driver's attention level by analyzing driving pattern, driving time, etc. while vehicle is being driven. The function will recommend a break when the driver's attention level falls below a certain level.

**Leading Vehicle Departure Alert**

Leading Vehicle Departure Alert will inform the driver when a detected vehicle in front departs from a stop.

**Detecting sensor**

[1]: Front view camera

The front view camera is used as a detecting sensor to detect driving patterns and front vehicle departure while vehicle is being driven.

Refer to the picture for the detailed location of the detecting sensor.

**⚠ CAUTION**

Always keep the front view camera in good condition to maintain optimal performance of Driver Attention Warning. For more details on the precautions of the front view camera, refer to "Forward Collision-Avoidance Assist (FCA) (Front view camera only)" on page 6-4.

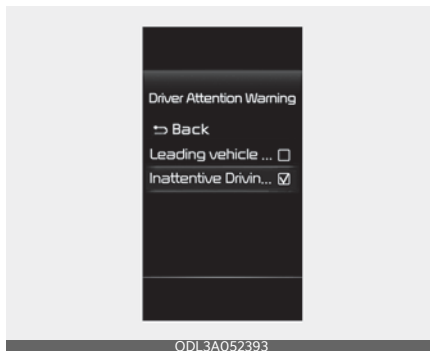
**Driver Attention Warning settings****Driver Attention Warning**

With the ENGINE START/STOP button in the ON position, select or deselect 'Driver Assistance → Driver Attention Warning' from the Settings menu to set whether or not to use each function.

- If 'Inattentive Driving Warning' is selected, Driver Attention Warning will inform the driver the driver's attention level and will recommend taking a break when the level falls below a certain level.

**\* NOTICE**

If the engine is restarted, Driver Attention Warning will maintain the last setting.

## Leading Vehicle Departure Alert

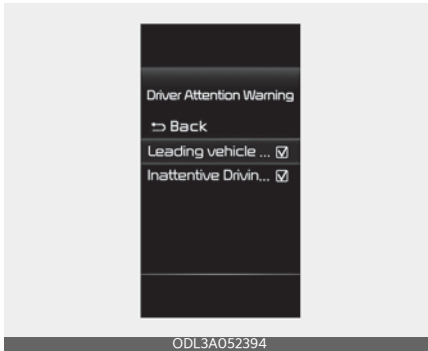

- If 'Leading Vehicle Departure Alert' is selected, the function will inform the driver when the front vehicle departs from a stop.

## Warning Timing

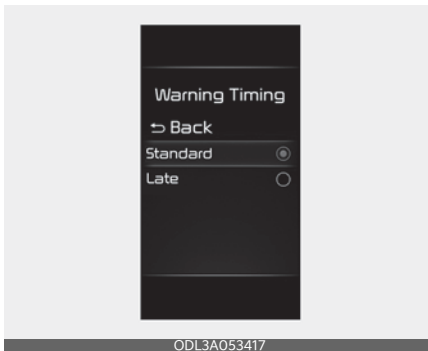

With the ENGINE START/STOP button in the ON position, select 'Driver Assistance → Warning Timing' from the Settings menu to change the initial warning activation time for Driver Attention Warning. When the vehicle is first delivered, Warning Timing is set to 'Standard'. If you change the Warning Timing, the warning time of other Driver Assistance systems may change.

### \* NOTICE

If the engine is restarted, Driver Attention Warning will maintain the last setting.

## Driver Attention Warning operation

### Basic function

#### Display and warning

The basic function of Driver Attention Warning is to inform the driver the 'Attention Level' and to warn the driver 'Consider taking a break'.

#### Attention level

##### Off

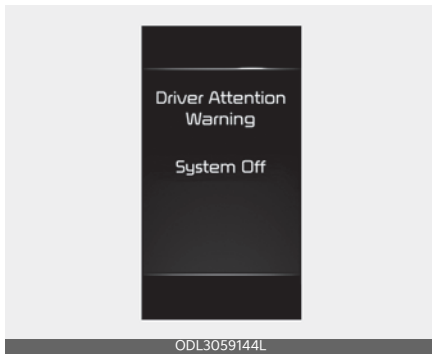

##### Standby

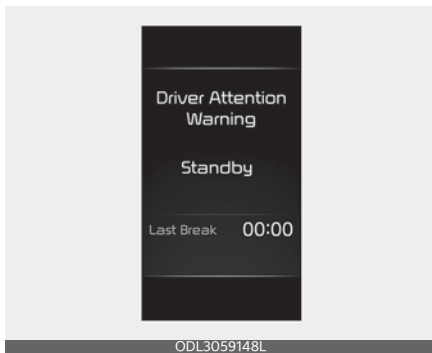

##### Attentive driving

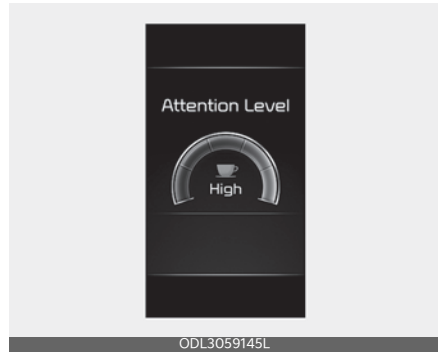

##### Inattentive driving

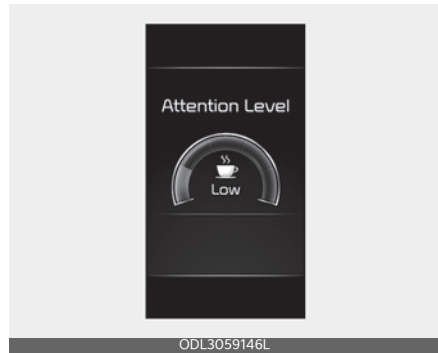

- The driver can monitor his/her driving conditions on the cluster.
  - When the 'Inattentive Driving Warning' is deselected from the Settings menu, 'System Off' is displayed.
  - The function will operate when vehicle speed is between 0~110 mph (0~180 km/h).
  - When vehicle speed is not within the operating speed, the message 'Standby' will be displayed.
- The driver's attention level is displayed on the scale of 1 to 5. The lower the level is, the more inattentive the driver is.

- The level decreases when the driver does not take a break for a certain period of time.

## Taking a break

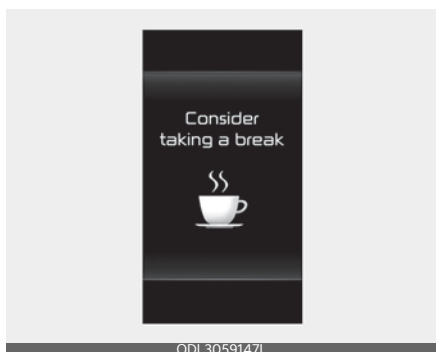

- The 'Consider taking a break' message will appear on the cluster and an audible warning will sound to suggest that the driver take a break, when the driver's attention level is below 1.
- Driver Attention Warning will not suggest a break when the total driving time is shorter than 10 minutes or 10 minutes has not passed after the last break was suggested.

### **⚠ WARNING**

For your safety, change the Settings after parking the vehicle at a safe location.

### **⚠ CAUTION**

- Driver Attention Warning may suggest a break depending on the driver's driving pattern or habits, even if the driver doesn't feel fatigued.
- Driver Attention Warning is a supplemental function and may not be able to determine whether the driver is inattentive.

- The driver who feels fatigued should take a break at a safe location, even though there is no break suggestion by Driver Attention Warning.

### **⚠ CAUTION**

- For more details on setting the functions in the cluster system, refer to "LCD display modes" on page 4-69.
- Driver Attention Warning will reset the last break time to 00:00 in the following situations:
  - The engine is turned off
  - The driver unfastens the seat belt and opens the driver's door.
  - The vehicle is stopped for more than 10 minutes.

## Leading Vehicle Departure Alert

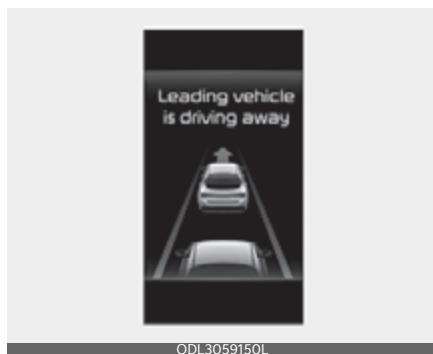

When the front vehicle departs from a stop, Leading Vehicle Departure Alert will inform the driver by displaying the 'Leading vehicle is driving away' message on the cluster and an audible warning will sound.

**⚠ WARNING**

- If any other function’s warning message is displayed or audible warning is generated, Leading Vehicle Departure Alert’s warning message may not be displayed and audible warning may not be generated.
- The driver should hold the responsibility to safely drive and control the vehicle.

**⚠ CAUTION**

- Leading Vehicle Departure Alert is a supplemental function and may not warn the driver whenever the front vehicle departs from a stop.
- Always check the front of the vehicle and road conditions before departure.

**\* NOTICE**

The images or colors may be displayed differently depending on the instrument panel specifications or theme.

**Driver Attention Warning malfunction and limitations**

**Driver Attention Warning malfunction**

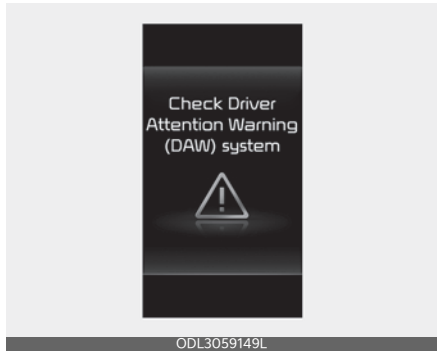

When Driver Attention Warning is not working properly, the 'Check Driver Attention Warning (DAW) system' warning message will appear on the cluster. If this occurs, have your vehicle inspected by an authorized Kia dealer.

**Limitations of Driver Attention Warning**

Driver Attention Warning may not work properly in the following situations:

- The vehicle is driven aggressively
- The vehicle intentionally crosses over lanes frequently
- The vehicle is controlled by Driver Assistance system, such as Lane Keeping Assist

### Leading vehicle departure alert function

- When the vehicle cuts in

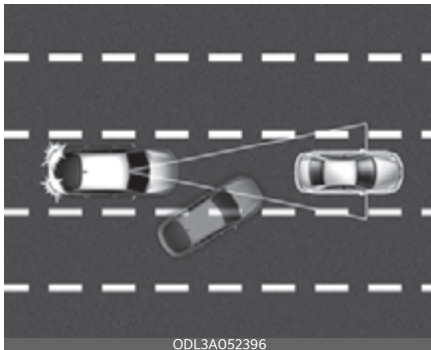
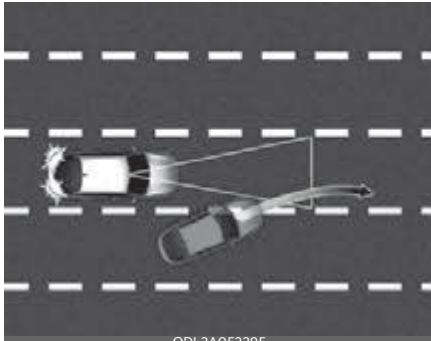

If a vehicle cuts in front of your vehicle, Leading Departure Alert may not operate properly.

- When the vehicle ahead sharply steers

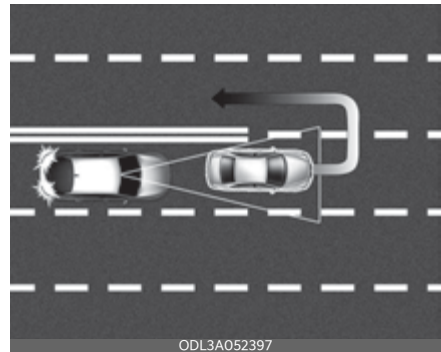

If the vehicle in front makes a sharp turn, such as to turn left or right or make a U- turn, etc., Leading Vehicle Departure Alert may not operate properly.

- When the vehicle ahead abruptly departs

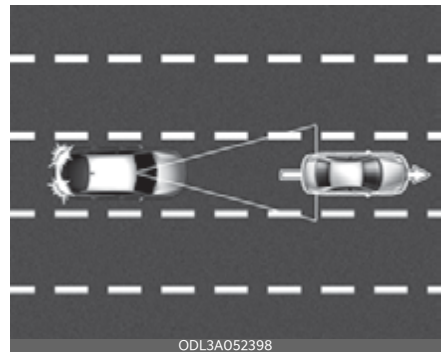

If the vehicle in front abruptly departs, Leading Vehicle Departure Alert may not operate properly.

- When a pedestrian or bicycle is between you and the vehicle ahead





If there is a pedestrian(s) or bicycle(s) in between you and the vehicle in front, Leading Vehicle Departure Alert may not operate properly.

- When in a parking lot

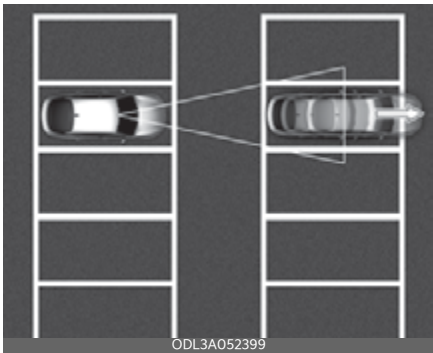

If a vehicle parked in front drives away from you, Leading Vehicle Departure Alert may warn you that the parked vehicle is driving away.

- When driving at a tollgate or intersection, etc.

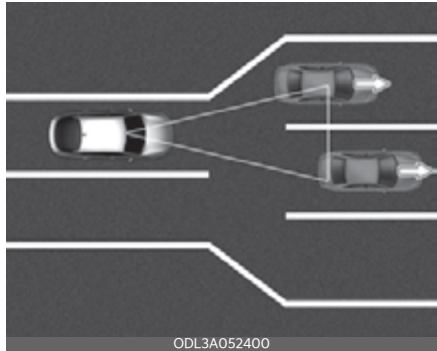

If you pass a tollgate or intersection with lots of vehicles or you drive where lanes are merged or divided frequently, Leading Vehicle Departure Alert may not operate properly.

**⚠ CAUTION**

For more details on the precautions of the front view camera, refer to "Forward Collision-Avoidance Assist (FCA) (Front view camera only)" on page 6-4.

## Cruise Control (CC) (if equipped)

Cruise Control allows you to program the vehicle to maintain a constant speed without pressing the accelerator pedal.



1. CRUISE (🚗) indicator
2. Set speed

This function is designed to function above approximately 20 mph (32 km/h).

- If Cruise Control is left on, (CRUISE indicator light in the instrument cluster appeared) Cruise Control can be switched on accidentally. Keep Cruise Control off (CRUISE indicator light OFF) when Cruise Control is not in use, to avoid inadvertently setting a speed.
- Use Cruise Control only when traveling on open highways in good weather.
- Do not use Cruise Control when it may not be safe to keep the car at a constant speed, for instance, driving in heavy or varying traffic, or on slippery (rainy, icy or snow-covered) or winding roads or over 6% uphill or downhill roads.
- Pay particular attention to the driving conditions whenever using Cruise Control.

### \* NOTICE

During normal Cruise Control operation, when the switch is activated or reactivated after applying the brakes, Cruise Control will energize after approximately 3 seconds. This delay is normal.

### \* NOTICE

To activate Cruise Control, depress the brake pedal at least once after turning the ENGINE START/STOP button to the ON position or starting the engine.

### ⚠ WARNING

#### Misuse of Cruise Control

Do not use Cruise Control if the traffic situation does not allow you to drive safely at a constant speed and with sufficient distance to the vehicle in front.

#### Cruise Control switch



- 🚗: Turns Cruise Control on or off.
- || 🔄: Temporarily cancel or resume Cruise Control.
- +: Increases Set speed.
- -: Decreases Set speed.

## Setting Cruise Control speed

1. Accelerate to the desired speed, and press the  button. The cruise indicator and the cruise set speed will appear on the instrument cluster. The set speed must be more than approximately 20 mph (32 km/h).



2. Release the accelerator pedal. The desired speed will automatically be maintained.

## Increasing Cruise Control set speed



Follow either of these procedures:

- Push the + switch up and hold it. Your vehicle set speed will increase by 5 mph (10 km/h). Release the switch at the speed you want.

- Push the + switch up, and release it immediately. The set speed will increase by 1 mph (1 km/h) each time you move the + switch up in this manner.

## Decreasing Cruise Control set speed



Follow either of these procedures:

- Push the - switch down and hold it. Your vehicle will gradually slow down. Release the switch at the speed you want to maintain.
- Push the - switch down and release it immediately. The set speed will decrease by 1 mph (1 km/h) each time the switch is operated in this manner.

## Accelerating temporarily with Cruise Control on

- If you want to speed up temporarily when Cruise Control is on, depress the accelerator pedal. Increased speed will not interfere with Cruise Control operation or change the set speed.
- To return to the set speed, take your foot off the accelerator pedal.

### Cruise Control will be temporarily canceled when:

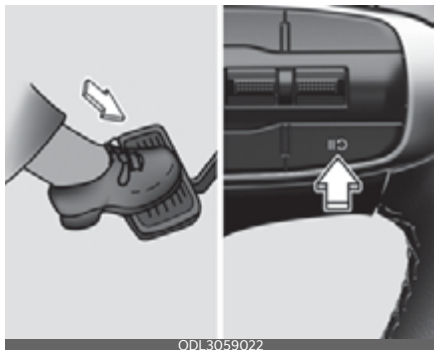

ODL3059022

Follow either of these procedures:

- Depress the brake pedal.
- Press || ↻ located on the steering wheel.
- Decrease the vehicle speed lower than the memory speed by 20 mph (32 km/h).
- Decrease the vehicle speed to less than approximately 20 mph (32 km/h).

Each of these actions will cancel Cruise Control operation (the cruise set speed will disappear), but it will not turn the function off. If you wish to resume Cruise Control operation, move up the switch (to RES+) located on your steering wheel. You will return to your previously preset speed.

### Restarting cruising speed at more than approximately 20 mph (32 km/h)



ODL3A051371

Push the + switch up or - switch down or press the || ↻ switch to resume Cruise Control.

If you push the + switch up or - switch down, the current speed on the cluster will be set as Cruise Control set speed.

If you use the || ↻ switch, the speed will resume to the recently set speed.

It will not restart, however, if the vehicle speed has dropped below approximately 20 mph (32 km/h).

## Turning Cruise Control off



Follow either of these procedures:

- Press the  button (The cruise status on the LCD screen will disappear).
- Turn the ignition off.

Both of these actions turn off Cruise Control operation. If you want to restart Cruise Control operation, repeat the steps provided in "Setting Cruise Control speed" on page 6-66.

## Smart Cruise Control (SCC) (if equipped)

Smart Cruise Control is designed to detect the vehicle ahead and help maintain the desired speed and minimum distance between the vehicle ahead.

### Overtaking Acceleration Assist

While Smart Cruise Control is operating, if the function judges that the driver is determined to overtake the vehicle in front, acceleration will be assisted.

### Detecting sensor



[1]: Front view camera [2]: Front radar

The front view camera and front radar are used as a detecting sensor to detect front vehicles.

Refer to the picture for the detailed location of the detecting sensor.

**⚠ CAUTION**

Always keep the front view camera and front radar in good condition to maintain optimal performance of Smart Cruise Control.

For more details on the precautions of the front view camera and front radar, refer to "Forward Collision-Avoidance Assist (FCA) (Sensor fusion) (if equipped)" on page 6-16.

**Smart Cruise Control settings**

**To turn on Smart Cruise Control**



- Press the Driving Assist button to turn on Smart Cruise Control. The speed will be set to the current speed on the cluster.
- If there is no vehicle in front of you, the set speed will be maintained, but if there is a vehicle in front of you, the speed may decrease to maintain the distance to the vehicle ahead. If the vehicle ahead accelerates, your vehicle will travel at a steady cruising speed after accelerating to the set speed.

**\* NOTICE**

If your driving speed is between 0~ 20 mph (0~ 32 km/h) when you press the Driving Assist button, Smart Cruise Control speed will be set to 20 mph (32 km/h).

**To set vehicle distance**



Each time the button is pressed, the Vehicle Distance changes as follows:

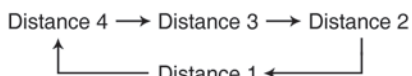

**\* NOTICE**

- If you drive at 56 mph (90 km/h), the distance is maintained as follows:  
 Distance 4 - approximately 172 ft. (52.5 m)  
 Distance 3 - approximately 130 ft. (40 m)  
 Distance 2 - approximately 106 ft. (32.5 m)  
 Distance 1 - approximately 82 ft. (25 m)
- The distance is set to the last set distance when the engine is restarted, or

when Smart Cruise Control was temporarily canceled.

### To increase set speed



- Push the + switch up and release it immediately. The set speed will increase by 1 mph (1 km/h) each time the switch is operated in this manner.
- Push the + switch up and hold it while monitoring the set speed on the cluster. The set speed will increase by 5 mph (10 km/h) each time the switch is operated in this manner. Release the switch when the desired speed is shown, and the vehicle will accelerate to that speed. You can increase the set speed to 110 mph (180 km/h).

### **⚠ WARNING**

Check the driving condition before using the + switch. Driving speed may sharply increase when you push up and hold the + switch.

### To decrease set speed



- Push the - switch down and release it immediately. The set speed will decrease by 1 mph (1 km/h) each time the switch is operated in this manner.
- Push the - switch down and hold it while monitoring the set speed on the cluster. The set speed will decrease by 5 mph (10 km/h) each time the switch is operated in this manner.

Release the switch at the speed you want to maintain. You can decrease the set speed to 20 mph (30 km/h).

### To temporarily cancel Smart Cruise Control

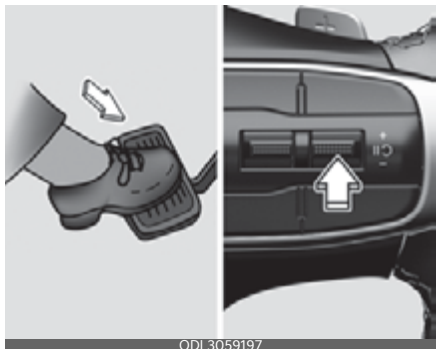

Press the || ⌚ switch or depress the brake pedal to temporarily cancel Smart Cruise Control.

### Resuming Smart Cruise Control



To resume Smart Cruise Control after the function was canceled, operate the +, - or || ⌚ switch.

If you push the + switch up or - switch down, the set speed will be set to the current speed on the cluster.

If you press the || ⌚ switch, vehicle speed will resume to the preset speed.

### **⚠ WARNING**

Check the driving condition before using the || ⌚ switch. Driving speed may sharply increase or decrease when you press the || ⌚ switch.

### Turning off Smart Cruise Control



Press the Driving Assist button to turn Smart Cruise Control off.

### **\* NOTICE**

If your vehicle is equipped with Manual Speed Limit Assist, press and hold the Driving Assist button to turn off Smart Cruise Control. However Manual Speed Limit Assist will turn on.

6

### Based on Drive Mode

- Smart Cruise Control will change acceleration based on the drive mode selected from Drive Mode Integrated Control system. Refer to the following chart.

Drive Mode	Smart Cruise Control
NORMAL	Normal
SPORT	Fast
SMART	Normal
CUSTOM	Based on Powertrain mode

### **\* NOTICE**

- For more details on Drive Mode, refer to "Drive mode integrated control system" on page 5-44.



- Smart Cruise Control may not turn on or off in some of the drive modes for the operating conditions are not satisfied.
- For the vehicle without the Drive Mode, acceleration of Smart Cruise Control is set to 'Normal'.
- Driving Safety Priority : Select 'Vehicle Settings → Driver Assistance → Warning Methods → Driving Safety Priority' on the Infotainment system. For safe driving, the audio volume will temporarily decrease to warn the driver with the audible warning.

## Warning Methods

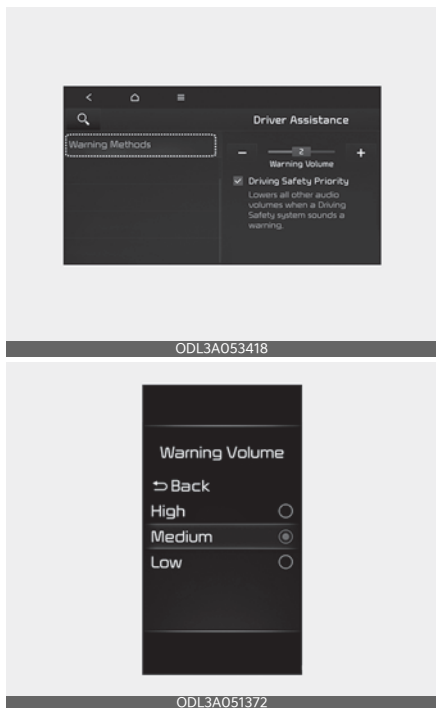

You can adjust the Warning Methods with the ignition switch or ENGINE START/ STOP button in the ON position.

- Warning Volume : Select 'User Settings → Driver Assistance → Warning Volume' on the instrument cluster or 'Settings → Vehicle → Driver Assistance → Warning Methods → Warning Volume' on the Infotainment system.

## \* NOTICE

- Ensure that Warning Methods you have set may apply to the warning volume of other driver assistance systems.
- Warning Methods will maintain its last setting even if the vehicle is restarted.
- The setting menu may not be available for your vehicle depending on the vehicle features and specifications.
- Descriptions of each driver assistance system may be slightly different from the owner's manual after updating the software of your infotainment system. In this case, scan the QR code in the infotainment system manual to access the web manual to review the changes.
- Depending on your update, the menu may be displayed as 'Warning Sound' or 'Warning methods'.

## Smart Cruise Control operation

### Operating conditions

Smart Cruise Control will operate when the following conditions are satisfied.

### Basic function

- The gear is in D (Drive)
- The driver's door is closed
- EPB (Electronic Parking Brake) is not applied
- Your driving speed is within the operating speed range
  - 5~110 mph (10~180 km/h): when there is no vehicle in front
  - 0~110 mph (0~180 km/h): when there is a vehicle in front
- ESC (Electronic Stability Control), TCS (Traction Control System) or ABS is on, but not controlling the vehicle
- Engine rpm is not in the red zone
- Forward Collision-Avoidance Assist brake control is not operating

### \* NOTICE

When your vehicle is stopped with a vehicle in front of you, Smart Cruise Control will turn on if the brake pedal is depressed.

### Overtaking Acceleration Assist

Overtaking Acceleration Assist will operate when the left turn signal indicator is turned on while Smart Cruise Control is operating, and the following conditions are satisfied:

- Your driving speed is above 40 mph (60 km/h)
- The hazard warning flasher is off
- A vehicle is detected in front of your vehicle

- Deceleration is not needed to maintain distance with the vehicle in front

### ⚠ WARNING

- When the left turn signal indicator is turned on while there is a vehicle ahead, the vehicle may accelerate temporarily. Pay attention to the road conditions at all times.
- Regardless of your country's driving direction, Overtaking Acceleration Assist will operate when the conditions are satisfied. When using the function in countries with different driving direction, always check the road conditions at all times.

## Smart Cruise Control display and control

### Basic function

Smart Cruise Control will be displayed as below depending on the status of the function.

You can see the status of Smart Cruise Control operation in the Driving Assist view on the cluster. Refer to "LCD display" on page 4-68.

- When operating

Operating

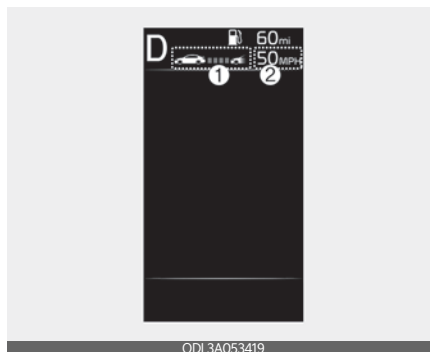



1. Whether there is a vehicle ahead and the selected distance level is displayed.
2. Set speed is displayed.
3. Whether there is a vehicle ahead and the selected target distance is displayed.

- When temporarily canceled

Temporarily canceled

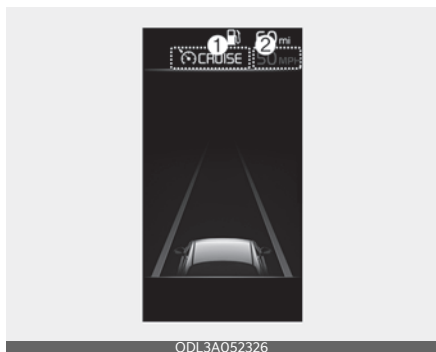

1. CRUISE indicator is displayed.
2. The previous set speed is shaded.
3. Vehicle ahead and distance level are not displayed.

**\* NOTICE**

- The distance of the front vehicle on the cluster is displayed according to the actual distance between your vehicle and the vehicle ahead.
- The target distance may vary according to the vehicle speed and the set distance level. If vehicle speed is low, even though the vehicle distance has changed, the change of the target vehicle may be small.

**To temporarily accelerate**

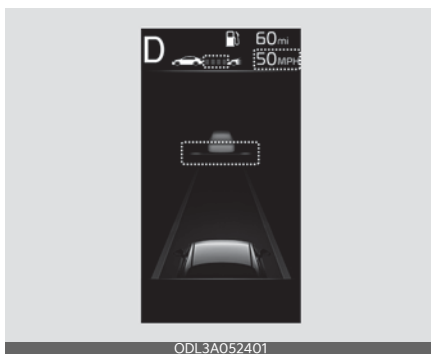

If you want to speed up temporarily when Smart Cruise Control is on, depress the accelerator pedal. While the speed is increasing, the set speed, distance level and target distance will blink on the cluster.

**⚠ WARNING**

Be careful when accelerating temporarily, because the speed and distance is not controlled automatically even if there is a vehicle in front of you.

## Smart Cruise Control temporarily canceled

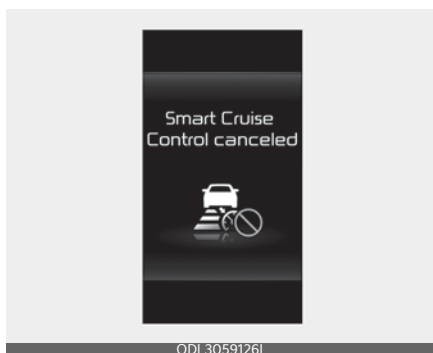

Smart Cruise Control will be temporarily canceled automatically when:

- The vehicle speed is above 120 mph (190 km/h)
- The vehicle is stopped for a certain period of time
- The accelerator pedal is continuously depressed for a certain period of time
- The conditions for Smart Cruise Control to operate is not satisfied

If Smart Cruise Control is temporarily canceled automatically, 'Smart Cruise Control canceled' warning message will appear on the cluster, and an audible warning will sound to warn the driver.

If Smart Cruise Control is temporarily canceled while the vehicle is at a standstill with the function operating, EPB (Electronic Parking Brake) may be applied.



### **⚠ WARNING**

When Smart Cruise Control is temporarily canceled, distance with the front vehicle will not be maintained. Always have your eyes on the road while driving, and if necessary, depress the brake pedal to

reduce your driving speed in order to maintain a safe distance.

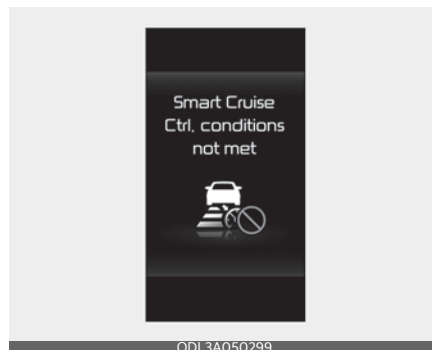
## Smart Cruise Control conditions not satisfied



If the Driving Assist  button, + switch, - switch or  switch is operated when Smart Cruise Control's operating conditions are not satisfied, the 'Smart Cruise Control conditions not met' will appear on the cluster, and an audible warning will sound.

## In traffic situation



In traffic, your vehicle will stop if the vehicle ahead of you stops. Also, if the

vehicle ahead of you starts moving, your vehicle will start as well.

In addition, after the vehicle has stopped and a certain time have passed, the 'Use switch or pedal to accelerate' message will appear on the cluster. Depress the accelerator pedal or operate the + switch, - switch or || ⤷ switch to start driving.

**⚠ WARNING**

While the message is displayed on the cluster, if there is no vehicle in front or the vehicle is far away from you, and the + switch, - switch or || ⤷ switch is operated, Smart Cruise Control will automatically cancel and the EPB will be applied. However, if the accelerator pedal is depressed, EPB will not be applied even though Smart Cruise Control is canceled. Always pay attention to the road condition ahead.

**Warning road conditions ahead**

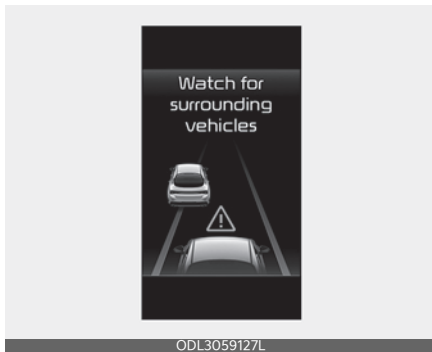

In the following situation, the 'Watch for surrounding vehicles' warning message will appear on the cluster, and an audible warning will sound to warn the driver of road conditions ahead.

- The vehicle in front disappears when Smart Cruise Control is maintaining the distance with the vehicle ahead while driving below a certain speed.

**⚠ WARNING**

Always pay attention to vehicles or objects that may suddenly appear in front of you, and if necessary, depress the brake pedal to reduce your driving speed in order to maintain a safe distance.

**Collision Warning**



While Smart Cruise Control is operating, when the collision risk with the vehicle ahead is high, the 'Collision Warning' warning message will appear on the cluster, and an audible warning will sound to warn the driver. Always have your eyes on the road while driving, and if necessary, depress the brake pedal to reduce your driving speed in order to maintain a safe distance.

**⚠ WARNING**

In the following situations, Smart Cruise Control may not warn the driver of a collision.

- The distance from the front vehicle is near, or the vehicle speed of the front vehicle is faster or similar to your vehicle
- The speed of the front vehicle is very slow or is at a standstill
- The accelerator pedal is depressed right after Smart Cruise Control is turned on

**⚠ WARNING**

Take the following precautions when using Smart Cruise Control:

- Smart Cruise Control does not substitute for proper and safe driving. It is the responsibility of the driver to always check the speed and distance to the vehicle ahead.
- Smart Cruise Control may not recognize unexpected and sudden situations or complex driving situations, so always pay attention to driving conditions and control your driving speed.
- Keep Smart Cruise Control off when the function is not in use to avoid inadvertently setting a speed.
- Do not open the door or leave the vehicle when Smart Cruise Control is operating, even if the vehicle is stopped.
- Always be aware of the selected speed and Vehicle Distance.
- Keep a safe distance according to road conditions and vehicle speed. If the Vehicle Distance is too close during high-speed driving, a serious collision may result.
- When maintaining distance with the vehicle ahead, if the front vehicle disappears, Smart Cruise Control may suddenly accelerate to the set speed. Always be aware of unexpected and sudden situations that may occur
- Vehicle speed may decrease on an upward slope and increase on a downward slope.
- Always be aware of situations such as when a vehicle cuts in suddenly.
- When you are towing a trailer or another vehicle, we recommend that Smart Cruise Control is turned off due to safety reasons.
- Turn off Smart Cruise Control when your vehicle is being towed.
- Smart Cruise Control may not operate normally if interfered by strong electromagnetic waves.
- Smart Cruise Control may not detect an obstacle in front and lead to a collision. Always look ahead cautiously to prevent unexpected and sudden situations from occurring.
- Vehicles moving in front of you with a frequent lane change may cause a delay in Smart Cruise Control's reaction or may cause Smart Cruise Control to react to a vehicle actually in an adjacent lane. Always drive cautiously to prevent unexpected and sudden situations from occurring.
- Always be aware of the surroundings and drive safely, even though a warning message does not appear or an audible warning does not sound.
- If any other function's warning message is displayed or warning sound is generated, Smart Cruise Control warning message may not be displayed and warning sound may not be generated.

- You may not hear the warning sound of Smart Cruise Control if the surrounding is noisy.
- The vehicle manufacturer is not responsible for any traffic violation or accidents caused by the driver.
- Always set the vehicle speed under the speed limit in your country.

### \* NOTICE

- Smart Cruise Control may not operate for a few seconds after the vehicle is started or the front view camera or front radar is initialized.
- You may hear a sound when the brake is controlled by Smart Cruise Control.

## Smart Cruise Control malfunction and limitations

### Smart Cruise Control malfunction

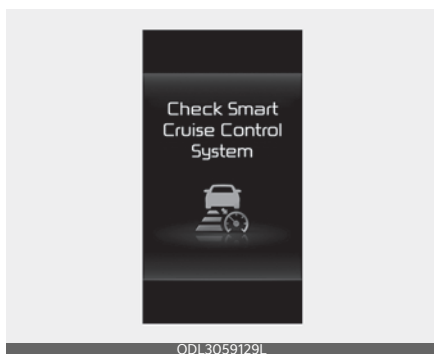

When Smart Cruise Control is not working properly, the 'Check Smart Cruise Control system' warning message will appear, and the  warning light will appear on the cluster. In this case, have your vehicle inspected by an authorized Kia dealer.

### Smart Cruise Control disabled

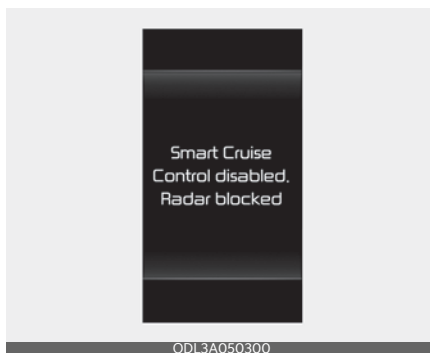

When the front radar cover or sensor is covered with snow, rain, or foreign material, it can reduce the detecting performance and temporarily limit or disable Smart Cruise Control.

If this occurs, the 'Smart Cruise Control disabled. Radar blocked' warning message will appear for a certain period of time on the cluster.

Smart Cruise Control will not operate normally when snow, rain or foreign matter is removed. Always keep it clean.

### ⚠ WARNING

Even though the warning message does not appear on the cluster, Smart Cruise Control may not properly operate.

### ⚠ CAUTION

Smart Cruise Control may not properly operate in an area (e.g. open terrain), where there is nothing to detect after turning ON the engine.

## Limitations of Smart Cruise Control

Smart Cruise Control may not operate normally, or it may operate unexpectedly under the following circumstances:

- The detecting sensor or the surroundings are contaminated or damaged
- Washer fluid is continuously sprayed, or the wiper is on
- The camera lens is contaminated due to tinted, filmed or coated windshield, damaged glass, or stuck of foreign material (sticker, bug, etc.) on the glass
- Moisture is not removed or frozen on the windshield
- The field of view of the front view camera is obstructed by sun glare
- Street light or light from an oncoming vehicle is reflected on the wet road surface, such as a puddle on the road
- The temperature around the front view camera is high or low
- An object is placed on the dashboard
- The surrounding is very bright
- The surrounding is very dark, such as in a tunnel, etc.
- The brightness changes suddenly, for example when entering or exiting a tunnel
- The brightness outside is low, and the headlamps are not on or are not bright
- Driving in heavy rain or snow, or thick fog
- Driving through steam, smoke or shadow
- Only part of the vehicle is detected
- The vehicle in front has no tail lights, tail lights are located unusually, etc.
- The brightness outside is low, and the tail lamps are not on or are not bright
- The rear of the front vehicle is small or does not look normal (i.e. tilted, over-turned, etc.)
- The front vehicle's ground clearance is low or high
- A vehicle suddenly cuts in front
- Your vehicle is being towed
- Driving through a tunnel or iron bridge
- Driving near areas containing metal substances, such as a construction zone, railroad, etc.
- A material is near that reflects very well on the front radar, such as a guardrail, nearby vehicle, etc.
- The bumper around the front radar is impacted, damaged or the front radar is out of position
- The temperature around the front radar is high or low
- Driving in large areas where there are few vehicles or structures (i.e. desert, meadow, suburb, etc.)
- The vehicle in front is made of material that does not reflect on the front radar
- Driving near a highway (or motorway) interchange or tollgate
- Driving on a slippery surface due to snow, water puddle, ice, etc.
- Driving on a curved road
- The vehicle in front is detected late
- The vehicle in front is suddenly blocked by an obstacle
- The vehicle in front suddenly changes lane or suddenly reduces speed
- The vehicle in front is bent out of shape



- The front vehicle's speed is fast or slow
- With a vehicle in front, your vehicle changes lane at low speed
- The vehicle in front is covered with snow
- Unstable driving
- You are on a roundabout and the vehicle in front is not detected
- You are continuously driving in a circle
- Driving in a parking lot
- Driving through a construction area, unpaved road, partial paved road, uneven road, speed bumps, etc.
- Driving on an incline road, curved road, etc.
- Driving through a roadside with trees or streetlights
- Your vehicle is moving unstable
- The adverse road conditions cause excessive vehicle vibrations while driving
- Your vehicle height is low or high due to heavy loads, abnormal tire pressure, etc.
- Driving through a narrow road where trees or grass are overgrown
- There is interference by electromagnetic waves, such as driving in an area with strong radio waves or electrical noise
- Driving on a curved road



On curves, Smart Cruise Control may not detect a vehicle in the same lane, and may accelerate to the set speed. Also, vehicle speed may rapidly decrease when the vehicle ahead is detected suddenly.

Select the appropriate set speed on curves and apply the brake pedal or accelerator pedal according to the road and driving conditions ahead.

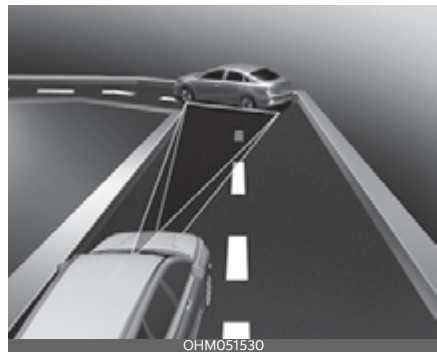

Your driving speed can be reduced due to a vehicle in the adjacent lane. Apply the accelerator pedal and select the appropriate set speed. Check to be sure that the road conditions permit safe operation of Smart Cruise Control.

- Driving on an inclined road



During uphill or downhill driving, Smart Cruise Control may not detect a moving vehicle in your lane, and cause your vehicle to accelerate to the set speed. Also, vehicle speed will rapidly decrease when the vehicle ahead is detected suddenly.

Select the appropriate set speed on inclines and apply the brake pedal or accelerator pedal according to the road and driving conditions ahead.

- Changing lanes

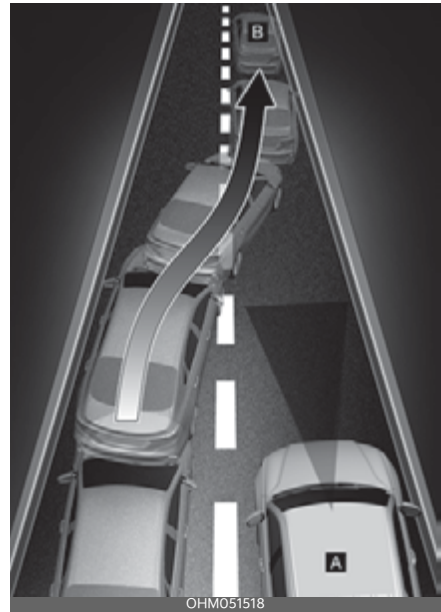

[A]: Your vehicle

[B]: Lane changing vehicle

When a vehicle [B] moves into your lane from an adjacent lane, it cannot be detected by the sensor until it is in the sensor's detection range. Smart Cruise Control may not immediately detect the vehicle when the vehicle changes lanes abruptly. In this case, you must maintain a safe braking distance, and if necessary, depress the brake pedal to reduce your driving speed in order to maintain a safe distance.

• Detecting vehicle

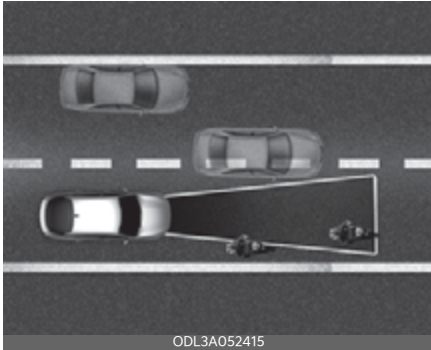

In the following cases, some vehicles in your lane cannot be detected by the sensor:

- Vehicles offset to one side
- Slow-moving vehicles or sudden-decelerating vehicles
- Oncoming vehicles
- Stopped vehicles
- Vehicles with small rear profile, such as trailers
- Narrow vehicles, such as motorcycles or bicycles
- Special vehicles
- Animals and pedestrians

Adjust your driving speed by depressing the brake pedal according to the road and driving conditions ahead.



In the following cases, the vehicle in front cannot be detected by the sensor:

- Vehicles with higher ground clearance or vehicles carrying loads that stick out of the back of the vehicle
- Vehicles that has the front lifted due to heavy loads
- You are steering your vehicle
- Driving on narrow or sharply curved roads

Adjust your driving speed by depressing the brake pedal according to the road and driving conditions ahead.

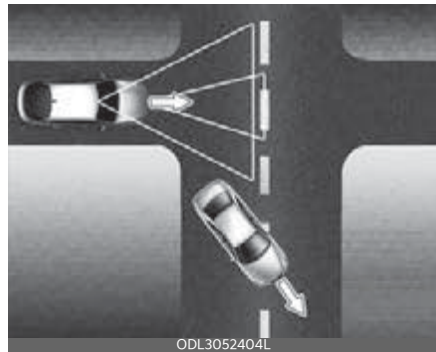

- When a vehicle ahead disappears at an intersection, your vehicle may accelerate.

Always pay attention to road and driving conditions while driving.

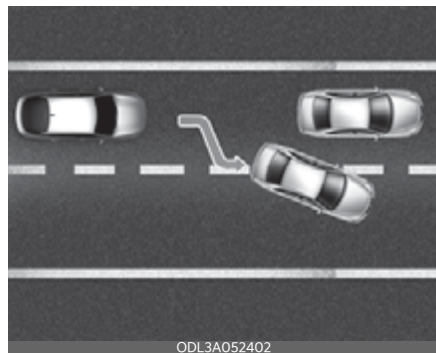

- When a vehicle in front of you merges out of the lane, Smart Cruise Control may not immediately detect the new vehicle that is now in front of you. Always pay attention to road and driving conditions while driving.

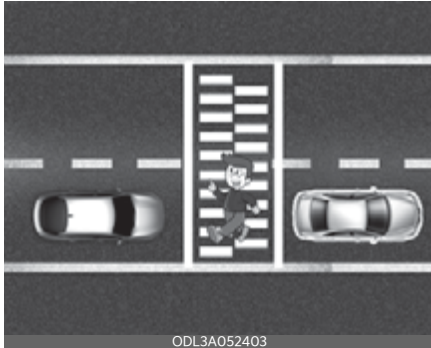

- Always look out for pedestrian when your vehicle is maintaining a distance with the vehicle ahead.

**This device complies with Part 15 of the FCC rules.**

Operation is subject to the following three conditions:

1. This device may not cause harmful interference, and
2. This device must accept any interference received, including interference that may cause undesired operation.
3. Changes or modifications not expressly approved by the party responsible for compliance could void the user's authority to operate the device.

**Radio frequency radiation exposure information:**

This equipment complies with FCC radiation exposure limits set forth for an uncontrolled environment. This equipment should be installed and operated with minimum distance of 8 in (20 cm) between the radiator (antenna) and your body.

This transmitter must not be colocated or operating in conjunction with any other antenna or transmitter.

## Navigation-based Smart Cruise Control (NSCC) (if equipped)

Navigation-based Smart Cruise Control will help automatically adjust vehicle speed when driving on highways (or motorways) by using road information from the navigation function while Smart Cruise Control is operating.

### \* NOTICE

- Navigation-based Smart Cruise Control is available only on controlled access road of certain highways.
- \* Controlled access road indicates roads with limited entrances and exits that allow uninterrupted high speed traffic flow. Only passenger cars and motorcycles are allowed on controlled access roads.

### Available highway (Controlled access road)

USA	Select Interstate Highway and U.S. (Federal) and State Highways
Canada	Select Provincial and Territorial Highways

- Additional highways may be expanded by future navigation updates.

### \* NOTICE

Navigation-based Smart Cruise Control operates on main roads of highways (or motorways), and does not operate on interchanges or junctions.

### ⚠ WARNING

Navigation-based Smart Cruise Control (NSCC) is a supplemental system and is not a substitute for safe driving. It is the responsibility of the driver to always check the speed and distance to the vehicle ahead. Always drive safely and use caution.

### Highway Curve Zone Auto Slow-down

If vehicle speed is high, Highway Curve Zone Auto Slowdown function will temporarily decelerate your vehicle or limit acceleration to help you drive safely on a curve based on the curve information from the navigation.

### Highway Set Speed Auto Change

Highway Set Speed Auto Change function automatically changes Smart Cruise Control set speed based on the speed limit information from the navigation.

### Navigation-based Smart Cruise Control settings

### Highway Auto Speed Change

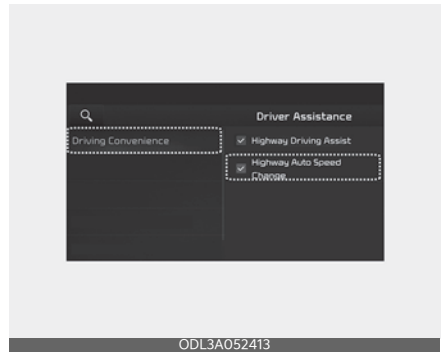

ODL3A052413

With the ENGINE START/STOP button in the ON position, select 'Driver Assistance → Driving Convenience → Highway Auto Speed Change' from the Settings menu to turn on Navigation-based Smart Cruise Control and deselect to turn off the function.

**\* NOTICE**

When there is a problem with Navigation-based Smart Cruise Control, the function cannot be set from the Settings menu.

**Navigation-based Smart Cruise Control operation**

**Operating conditions**

Navigation-based Smart Cruise Control is ready to operate if all of the following conditions are satisfied:

- Smart Cruise Control is operating
- Driving on main roads of highways (or motorways)

**\* NOTICE**

For more details on how to operate Smart Cruise Control, refer to "Smart Cruise Control (SCC) (if equipped)" on page 6-68.

**Navigation-based Smart Cruise Control display and control**

When Navigation-based Smart Cruise Control operates, it will be displayed on the cluster as follows:

**Navigation-based Smart Cruise Control standby**



If the operating conditions are satisfied, the white **AUTO** symbol will appear.

**Navigation-based Smart Cruise Control operating**



If temporary deceleration is required in the standby state and Navigation-based Smart Cruise Control is operating, the green **AUTO** symbol will appear on the cluster.

If the Highway Set Speed Auto Change function operates, the green **AUTO** symbol and set speed will appear on the cluster, and an audible warning will sound.

**⚠ WARNING**

'Drive carefully' warning message will appear in the following circumstances:



- Navigation-based Smart Cruise Control is not able to slow down your vehicle to a safe speed



**\* NOTICE**

Highway Curve Zone Auto Slowdown and Highway Set Speed Auto Change function use the same **AUTO** symbol.

**Highway Curve Zone Auto Slowdown**

- Depending on the curve ahead on the highway (or motorway), the vehicle will decelerate, and after passing the curve, the vehicle will accelerate to Smart Cruise Control set speed.
- Vehicle deceleration time may differ depending on the vehicle speed and the degree of the curve on the road. The higher the driving speed, deceleration will start faster.

**Highway Set Speed Auto Change**

- Highway Set Speed Auto Change function will operate when Smart Cruise Control set speed and the highway (or motorway) speed limit is matched.
- While Highway Set Speed Auto Change function is operating, when the highway (or motorway), speed limit changes, Smart Cruise Control set speed automatically changes to the changed speed limit.
- If Smart Cruise Control set speed is adjusted different from the speed limit, Highway Set Speed Auto Change function will be in the standby state.
- If Highway Set Speed Auto Change function has changed to the standby state by driving on a road other than the highway (or motorway) main road, Highway Set Speed Auto Change function will operate again when you drive on the main road again without setting the set speed.
- If Highway Set Speed Auto Change function has changed to the standby state by depressing the brake pedal or pressing the **||**  button on the steering wheel, press the **||**  switch to restart the function.
- Highway Set Speed Auto Change function does not operate on highway interchanges or junctions.

**\* NOTICE**

- Highway Set Speed Auto Change function only operates based on the speed limits of the highway (or motorway), it does not work with the speed cameras.
- When Highway Set Speed Auto Change function is operating, the

vehicle automatically accelerates or decelerates when the highway (or motorway) speed limit changes.

- If the speed limit is higher than the speed limit of the speed camera while Highway Set Speed Auto Change function is operating, an audible warning may sound.
- The maximum set speed for Highway Set Speed Auto Change function is 90 mph (140 km/h).
- If the speed limit of a new road is not updated in the navigation, Highway Set Speed Auto Change function may not operate properly.
- If the speed unit is set to a unit other than the speed unit used in your country, Highway Set Speed Auto Change function may not operate properly.

### Limitations of Navigation-Based Smart Cruise Control

Navigation-based Smart Cruise Control may not operate normally under the following circumstances:

- The navigation is not working properly
- Speed limit and road information in the navigation is not updated
- The map information and the actual road is different because of real-time GPS data or map information error
- The infotainment system is overloaded by simultaneously performing functions such as route search, video playback, voice recognition, etc.
- The navigation searches for a route while driving
- GPS signals are blocked in areas such as a tunnel

- Map information is not transmitted due to infotainment system's abnormal operation
- A road that divides into two or more roads and joins again
- The navigation cannot detect the current vehicle position (ex: elevated roads including overpass adjacent to general roads or nearby roads exist in a parallel way)
- The driver goes off course the route set in the navigation
- The route to the destination is changed or canceled by resetting the navigation (Including re-search based on real-time traffic information)
- The vehicle enters a service station or rest area
- The speed limit of some sections changes according to the road situations
- Android Auto or Car Play is operating
- The navigation is being updated while driving
- The navigation is being restarted while driving
- There is bad weather, such as heavy rain, heavy snow, etc.
- Driving on a road under construction
- Driving on a road that is controlled
- Driving on a road that is sharply curved
- Driving on roads with intersections, roundabouts, straight entrances and exits, etc.



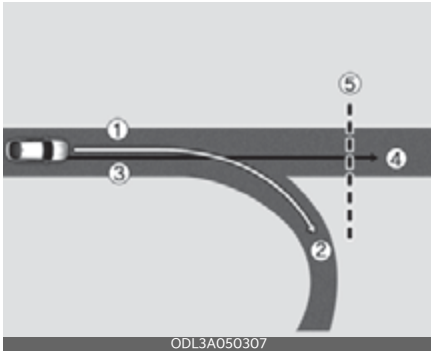

[1]: Set route, [2]: Branch line, [3]: Driving route, [4]: Main road, [5]: Curved road section

- When there is a difference between the navigation set route (branch line) and the driving route (main road), Highway Curve Zone Auto Slowdown function may not operate until the driving route is recognized as the main road.
- When the vehicle's driving route is recognized as the main road by maintaining the main road instead of the navigation set route, Highway Curve Zone Auto Slowdown function will operate. Depending on the distance to the curve and the current vehicle speed, vehicle deceleration may not be sufficient or may decelerate rapidly.

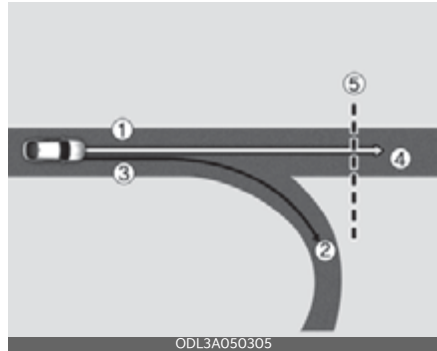

[1]: Main road, [2]: Branch line, [3]: Driving route, [4]: Set route, [5]: Curved road section

- When there is a difference between the navigation route (main road) and the driving route (branch line), Highway Curve Zone Auto Slowdown function will operate based on the curve information on the main road.
- When it is judged that you are driving out of the route by entering the highway interchange or junction, Highway Curve Zone Auto Slowdown function will not operate.

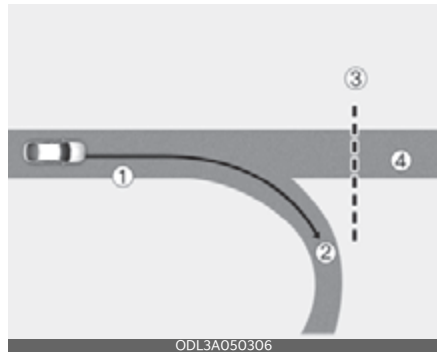

[1]: Driving route, [2]: Branch line, [3]: Curved road section, [4]: Main road

- If there is no destination set on the navigation, Highway Curve Zone Auto Slowdown function will operate based

on the curve information on the main road.

- Even if you depart from the main road, Highway Curve Zone Auto Slow-down function may temporarily operate due to navigation information of the highway curve section.

### WARNING

- Navigation-based Smart Cruise Control is not a substitute for safe driving practices, but a convenience function. Always have your eyes on the road, and it is the responsibility of the driver to avoid violating traffic laws.
- The navigation's speed limit information may differ from the actual speed limit information on the road. It is the driver's responsibility to check the speed limit on the actual driving road or lane.
- Navigation-based Smart Cruise Control may not operate due to the existence of leading vehicles and the driving conditions of the vehicle. Always pay attention to road and driving conditions while driving.
- When you are towing a trailer or another vehicle, we recommend that Navigation-based Smart Cruise Control is turned off due to safety reasons.
- After you pass through a tollgate on a highway (or motorway), Navigation-based Smart Cruise Control will operate based on the first lane. If you enter one of the other lanes, the function might not operate properly.
- The vehicle will accelerate if the driver depresses the accelerator pedal while Navigation-based Smart Cruise Control is operating, and the function will not decelerate the vehicle.

- If the driver accelerates and releases the accelerator pedal while Navigation-based Smart Cruise Control is operating, the vehicle may not decelerate sufficiently or may rapidly decelerate to a safe speed.
- If the curve is too large or too small, Navigation-based Smart Cruise Control may not operate.
- Navigation-based Smart Cruise Control will automatically be canceled when you leave the highway (or motorway) main road. Always pay attention to road and driving conditions while driving.

### NOTICE

- When the function is activated, the vehicle decelerates automatically before reaching the curved road according to its curvature, and the driving speed returns to the speed set by Smart Cruise Control after passing the curved section.
- The speed information on the cluster and navigation may differ.
- The time gap could occur between the navigation's guidance and when Navigation-based Smart Cruise Control operation starts and ends.
- Even if you are driving at a speed lower than Smart Cruise Control set speed, acceleration may be limited by the curve sections ahead.
- If Navigation-based Smart Cruise Control is operating while leaving the main road to enter an interchange, junction, rest area, etc., the function may operate for a certain period of time.
- Deceleration by Navigation-based Smart Cruise Control may feel it is not sufficient due to road conditions such

as uneven road surfaces, narrow lanes, etc.

---

### This device complies with Part 15 of the FCC rules.

Operation is subject to the following three conditions:

1. This device may not cause harmful interference, and
2. This device must accept any interference received, including interference that may cause undesired operation.
3. Changes or modifications not expressly approved by the party responsible for compliance could void the user's authority to operate the device.

### Radio frequency radiation exposure information:

This equipment complies with FCC radiation exposure limits set forth for an uncontrolled environment. This equipment should be installed and operated with minimum distance of 8 in (20 cm) between the radiator (antenna) and your body. This transmitter must not be collocated or operating in conjunction with any other antenna or transmitter.

## Lane Following Assist (LFA)

Lane Following Assist is designed to help detect lane markings and/or vehicles on the road, and assists the driver's steering to help keep the vehicle between lanes.

### Detecting sensor



[1]: Front view camera

The front view camera is used as a detecting sensor to detect lane markings and front vehicles.

Refer to the picture for the detailed location of the detecting sensor.

### **CAUTION**

For more details on the precautions of the front view camera, refer to "Forward Collision-Avoidance Assist (FCA) (Front view camera only)" on page 6-4.

---

## Lane Following Assist settings

### Turning Lane Following Assist ON/OFF



With the ENGINE START/STOP button in the ON position, shortly press Lane Following Assist button located on the steering wheel to turn on Lane Following Assist. The white or green  indicator light will appear on the cluster. Press the button again to turn off the function.

#### \* NOTICE

If the engine is restarted, the function will maintain the last setting.

## Warning Methods

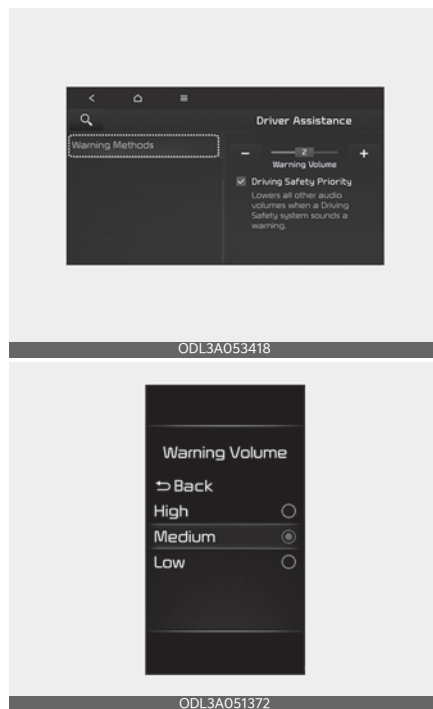

You can adjust the Warning Methods with the ignition switch or ENGINE START/ STOP button in the ON position.

- Warning Volume : Select 'User Settings → Driver Assistance → Warning Volume' on the instrument cluster or 'Settings → Vehicle → Driver Assistance → Warning Methods → Warning Volume' on the Infotainment system.
- Driving Safety Priority : Select 'Vehicle Settings → Driver Assistance → Warning Methods → Driving Safety Priority' on the Infotainment system. For safe driving, the audio volume will temporarily decrease to warn the driver with the audible warning.

## \* NOTICE

- Ensure that Warning Methods you have set may apply to the warning volume of other driver assistance systems.
- Warning Methods will maintain its last setting even if the vehicle is restarted.
- The setting menu may not be available for your vehicle depending on the vehicle features and specifications.
- Descriptions of each driver assistance system may be slightly different from the owner's manual after updating the software of your infotainment system. In this case, scan the QR code in the infotainment system manual to access the web manual to review the changes.
- Depending on your update, the menu may be displayed as 'Warning Sound' or 'Warning methods'.

## Lane Following Assist operation

### Lane Following Assist



If the vehicle ahead and/or both lane markings are detected and your driving speed is below 110 mph (180 km/h), the green  indicator light will appear on the cluster, and the function will help the vehicle stay in lane by assisting the steering wheel.

## ⚠ CAUTION

When the steering wheel is not assisted, the green  indicator light will blink and change to white.

## Hands-off warning

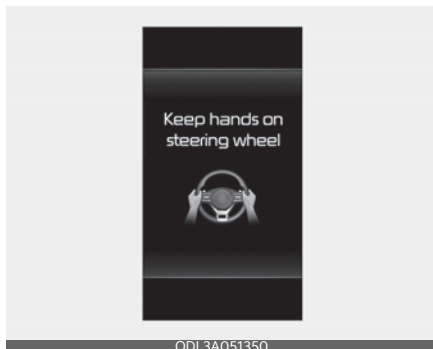

If the driver takes their hands off the steering wheel for several seconds, the 'Keep hands on the steering wheel' warning message will appear and an audible warning will sound in stages.

First stage: Warning message

Second stage: Warning message (red steering wheel) and audible warning

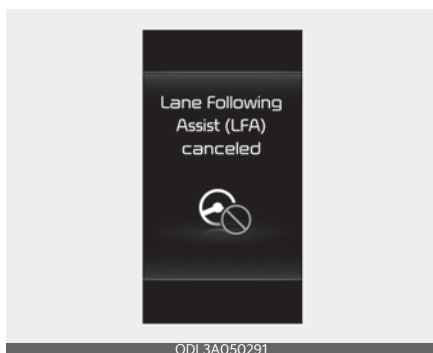

If the driver still does not have their hands on the steering wheel after the hands-off warning, the 'Lane Following Assist (LFA) canceled' warning message will appear and Lane Following Assist will be automatically canceled.

### **⚠ WARNING**

- The steering wheel may not be assisted if the steering wheel is held very tight or the steering wheel is steered over a certain degree.
- Lane Following Assist does not operate at all times. It is the responsibility of the driver to safely steer the vehicle and to maintain the vehicle in its lane.
- The hands-off warning message may appear late depending on road conditions. Always have your hands on the steering wheel while driving.
- If the steering wheel is held very lightly the hands-off warning message may appear because the function may not recognize that the driver has their hands on the steering wheel.
- If you attach objects to the steering wheel, the hands-off warning may not work properly.

### **⚠ CAUTION**

For more details on setting the functions in the cluster system, refer to "LCD display modes" on page 4-69.

- When both lane markings are detected, the lane lines on the cluster will change from gray to white.

Lane undetected

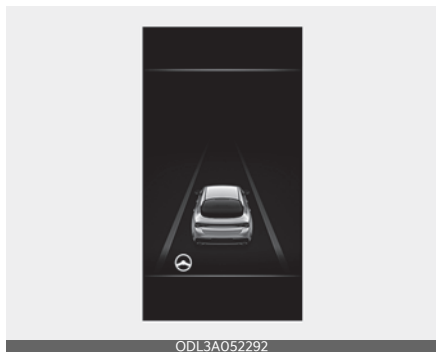

Lane detected



## Lane Following Assist malfunction and limitations

### Lane Following Assist malfunction

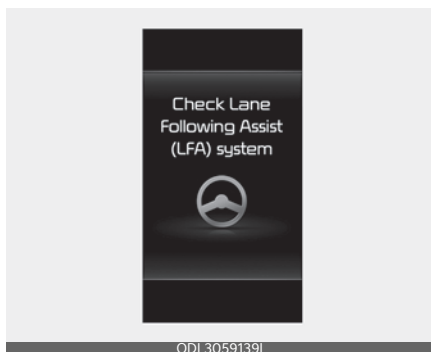

When Lane Following Assist is not working properly, the 'Check Lane Following Assist (LFA) system' warning message will appear on the cluster. If this occurs, have your vehicle inspected by an authorized Kia dealer.

### Limitations of Lane Following Assist

For more details on system limitations, refer to "Lane Keeping Assist (LKA)" on page 6-31.

### **CAUTION**

For more details on the function precautions, refer to "Lane Keeping Assist (LKA)" on page 6-31.

- If lane markings are not detected, steering wheel control by Lane Following Assist can be limited depending on whether a vehicle is in front or the driving conditions of the vehicle.
- Even though the steering is assisted by Lane Following Assist, the driver may control the steering wheel.
- The steering wheel may feel heavier or lighter when the steering wheel is assisted by Lane Following Assist than when it is not.

## Highway Driving Assist (HDA) (if equipped)

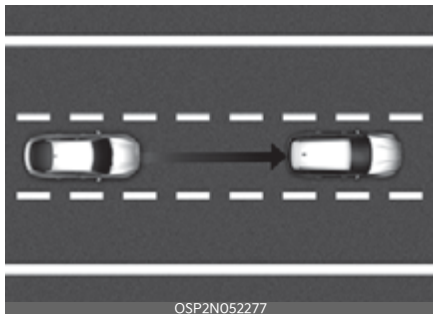

Highway Driving Assist is designed to help detect vehicles and lanes ahead, and help maintain distance from the vehicle ahead, maintain the set speed, and keep the vehicle between lanes while driving on the highway (or motorway).

### \* NOTICE

Highway Driving Assist operates on main roads of highways (or motorways), and does not operate on interchanges or junctions.

### \* NOTICE

- Highway Driving Assist is available only on controlled access road of certain highways.
- \* Controlled access road indicates roads with limited entrances and exits that allow uninterrupted high speed traffic flow. Only passenger cars and motor-cycles are allowed on controlled access roads.

### Available highway (Controlled access road)

USA	Select Interstate Highway and U.S. (Federal) and State Highways
Canada	Select Provincial and Territorial Highways

- Additional highways may be expanded by future navigation updates.

## Detecting sensor



[1] : Front view camera, [2]: Front radar  
Refer to the picture for the detailed location of the detecting sensors.



**CAUTION**

For more details on the precautions of the detecting sensors, refer to "Forward Collision-Avoidance Assist (FCA) (Sensor fusion) (if equipped)" on page 6-16.

**Highway Driving Assist settings**

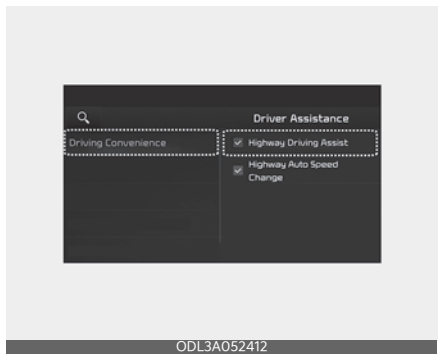

With the ENGINE START/STOP button in the ON position, select or deselect 'Driver Assistance → Driving Convenience' from the Settings menu to set whether or not to use each function.

- If 'Highway Driving Assist' is selected, it helps maintain distance from the vehicle ahead, maintain the set speed, and center the vehicle in the lane.

**\* NOTICE**

- If there is a problem with the functions, the settings cannot be changed. In this case, have your vehicle inspected by an authorized Kia dealer.
- If the engine is restarted, the functions will maintain the last setting.

**WARNING**

For your safety, change the Settings after parking the vehicle at a safe location.

**Warning Methods**

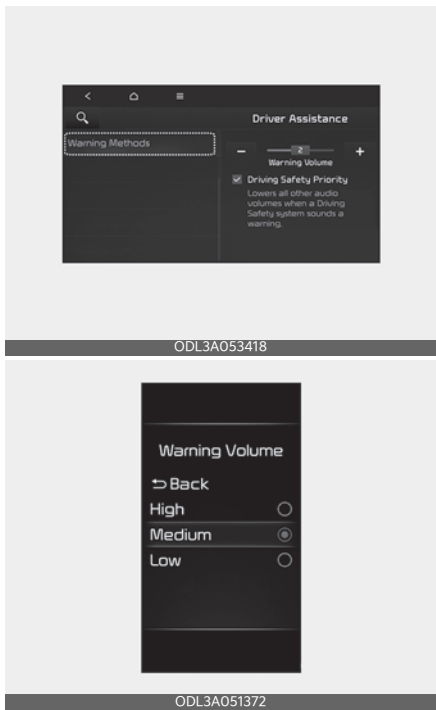

You can adjust the Warning Methods with the ignition switch or ENGINE START/ STOP button in the ON position.

- Warning Volume : Select 'User Settings → Driver Assistance → Warning Volume' on the instrument cluster or 'Settings → Vehicle → Driver Assistance → Warning Methods → Warning Volume' on the Infotainment system.
- Driving Safety Priority : Select 'Vehicle Settings → Driver Assistance → Warning Methods → Driving Safety Priority' on the Infotainment system. For safe driving, the audio volume will temporarily decrease to warn the driver with the audible warning.

**\* NOTICE**

- Ensure that Warning Methods you have set may apply to the warning volume of other driver assistance systems.
- Warning Methods will maintain its last setting even if the vehicle is restarted.
- The setting menu may not be available for your vehicle depending on the vehicle features and specifications.
- Descriptions of each driver assistance system may be slightly different from the owner's manual after updating the software of your infotainment system. In this case, scan the QR code in the infotainment system manual to access the web manual to review the changes.
- Depending on your update, the menu may be displayed as 'Warning Sound' or 'Warning methods'.

**Highway Driving Assist operation**

**Display and control**

Highway Driving Assist will be displayed as below depending on the status of the function.

Operating



Standby

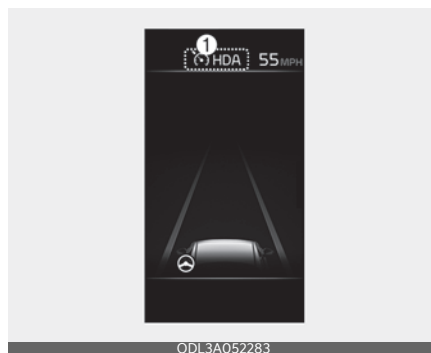

1. Highway Driving Assist indicator, whether there is a vehicle ahead and the selected distance level are displayed.
  - Highway Driving Assist indicator
    - Green **HDA**: Operating state
    - White **HDA**: Standby state
2. Set speed is displayed.
3. Lane Following Assist indicator displayed.
4. Whether there is a vehicle ahead and the target vehicle to Vehicle Distance are displayed.
5. Whether the lane is detected or not is displayed.

\* For more details on Smart Cruise control, refer to "Smart Cruise Control (SCC) (if equipped)" on page 6-68.

\* For more details on Lane Following Assist, refer to "Lane Following Assist (LFA)" on page 6-90.

**Highway Driving Assist operating**

Highway Driving Assist operates when:

- Driving on the main road of highways, and turning on Highway Driving Assist by pressing the Driving Assist button.

- Entering the main road of highways while Lane Following assist and Smart Cruise Control are operating.

### Restarting after stopping



When Highway Driving Assist is operating, your vehicle will stop if the vehicle ahead of you stops. Also, if the vehicle ahead of you starts moving approximately within 30 seconds after the stop, your vehicle will start as well. In addition, after the vehicle has stopped and approximately 30 seconds have passed, the 'Use switch or pedal to accelerate' message will appear on the cluster. Depress the accelerator pedal or operate the + switch, - switch or || ⌚ switch to start driving.

### Hands-off warning

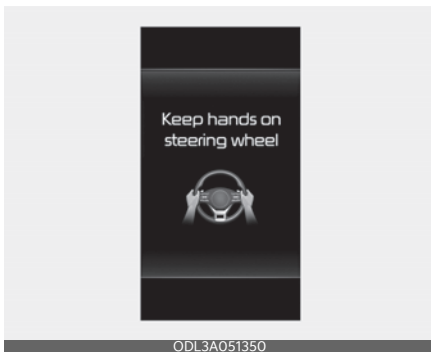

If the driver takes their hands off the steering wheel for several seconds, the 'Keep hands on steering wheel' warning message will appear and an audible warning will sound in stages.

- First stage: Warning message
- Second stage: Warning message (red steering wheel) and audible warning

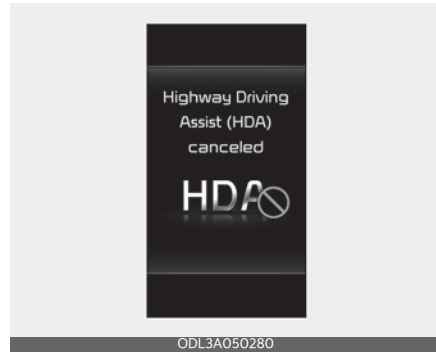

If the driver still does not have their hands on the steering wheel after the hands-off warning, the 'Highway Driving Assist (HDA) canceled' warning message will appear and Highway Driving Assist and Lane Following Assist will be automatically canceled.

### Highway Driving Assist standby

When Smart Cruise Control is temporarily canceled while Highway Driving Assist is operating, Highway Driving Assist will be in the standby state. At this time, Lane Following Assist will operate normally.

## Highway Driving Assist malfunction and limitations

### Highway Driving Assist malfunction

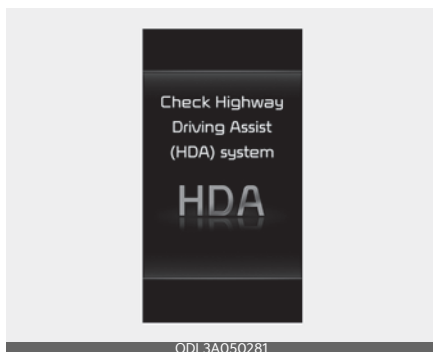

When Highway Driving Assist is not working properly, the 'Check Highway Driving Assist (HDA) system' warning message will appear, and the  warning light will appear on the cluster. In this case, have your vehicle inspected by an authorized Kia dealer.

#### **WARNING**

- The driver is responsible for controlling the vehicle for safe driving.
  - Always have your hands on the steering wheel while driving.
  - Highway Driving Assist is a supplemental function that assists the driver in driving the vehicle and is not a complete autonomous driving function. Always check road conditions, and if necessary, take appropriate actions to drive safely.
  - Always have your eyes on the road, and it is the responsibility of the driver to avoid violating traffic laws. The vehicle manufacturer is not responsible for any traffic violation or accidents caused by the driver.
- Highway Driving Assist may not be able to recognize all traffic situations. The function may not detect possible collisions due to limitations of the function. Always be aware of the limitations of the function. Obstacles such as vehicles, motorcycles, bicycles, pedestrians, guard rail, toll gate, unspecified objects, structures, etc. that may collide with the vehicle may not be detected.
  - Highway Driving Assist will turn off automatically under the following situations:
    - Driving on roads that the function does not operate, such as a rest area, intersection, junction, etc.
    - The navigation does not operate properly such as when the navigation is being updated or restarted
  - Highway Driving Assist may inadvertently operate or turn off depending on road conditions (navigation information) and surroundings.
  - Lane Following Assist function may be temporarily disabled when the front view camera cannot detect lanes properly or the hands-off warning is on.
  - You may not hear the warning sound of Highway Driving Assist if the surrounding is noisy.
  - If the vehicle is driven at high speed above a certain speed at a curve, your vehicle may drive to one side or may depart from the driving lane.
  - When you are towing a trailer or another vehicle, we recommend that Highway Driving Assist is turned off due to safety reasons.
  - The hands-off warning message may appear early or late depending on how the steering wheel is held or road

conditions. Always have your hands on the steering wheel while driving.

- For your safety, please read the owner's manual before using Highway Driving Assist.
- Highway Driving Assist will not operate when the engine is started, or when the detecting sensors or navigation is being initialized.

### Limitations of Highway Driving Assist

Highway Driving Assist and Highway Lane Change function may not operate normally, or may not operate under the following circumstances:

- The map information and the actual road is different because the navigation is not updated
- The map information and the actual road is different because of real-time GPS data or map information error
- The infotainment system is overloaded by simultaneously performing functions such as route search, video playback, voice recognition, etc.
- GPS signals are blocked in areas such as a tunnel
- The driver goes off course or the route to the destination is changed or canceled by resetting the navigation (Including re-search based on real-time traffic information)
- The vehicle enters a service station or rest area
- Android Auto or Car Play is operating
- The navigation cannot detect the current vehicle position (ex: elevated roads including overpass adjacent to general roads or nearby roads exist in a parallel way)

### CAUTION

For more details on the limitations of the front view camera and front radar, refer to "Forward Collision-Avoidance Assist (FCA) (Sensor fusion) (if equipped)" on page 6-16.

### This device complies with Part 15 of the FCC rules.

Operation is subject to the following three conditions:

1. This device may not cause harmful interference, and
2. This device must accept any interference received, including interference that may cause undesired operation.
3. Changes or modifications not expressly approved by the party responsible for compliance could void the user's authority to operate the device.

### Radio frequency radiation exposure information:

This equipment complies with FCC radiation exposure limits set forth for an uncontrolled environment. This equipment should be installed and operated with minimum distance of 8 in (20 cm) between the radiator (antenna) and your body. This transmitter must not be collocated or operating in conjunction with any other antenna or transmitter.

## Rear View Monitor (RVM) (if equipped)



ODL3A040082

Rear View Monitor will show the area behind the vehicle to assist you when parking or backing up.

### **⚠ WARNING**

The wide-rear view camera does not cover the complete area behind the vehicle. The driver should always check the rear area directly through the inside and side view mirror before parking or backing up.

\* If your vehicle is equipped with an infotainment system, you can learn how to set it up on the website via QR code in the infotainment quick reference guide.

## Detecting sensor



ODL3A052370

[1] : Wide-rear view camera

Refer to the picture for the detailed location of the detecting sensor.

### **⚠ WARNING**

The image shown on the screen may differ from the actual distance of the object. Make sure to directly check the vehicle's surroundings for safety.

## Rear View Monitor settings

### Camera settings



ODL3A042154

- You can change Rear View Monitor settings by pressing the setup icon  on the screen while the function is operating, or select 'Driver Assistance

→ Parking Safety → Camera Settings' from the Settings menu while the vehicle engine is running.

- You can change the settings of the following information.
  - Rear View Parking Guide Lines
- You can change the following lists in the screen settings:
  - brightness (daytime)
  - brightness (nighttime)
  - contrast

### Rear View Parking Guide Lines

If 'Rear view reference lines (Rear View Parking Guide Lines)' is selected, the rear view parking guide lines and rear top view guide lines will be displayed at the left side of the infotainment system screen.

#### \* NOTICE

The horizontal guideline of the Rear View Parking Guidance shows the distance of 1.6 ft. (0.5 m), 3.3 ft. (1 m) and 7.6 ft. (2.3 m) from the vehicle. The horizontal guideline of the Rear Top View Parking Guidance shows the distance of 1 ft. (0.3m), 4.9 ft. (1.5 m) from the vehicle.

## Rear View Monitor operation

### Parking/View button



[1] : Parking/View button

Press the Parking/View button (1) to turn Rear View Monitor on or off.

### Warning Methods

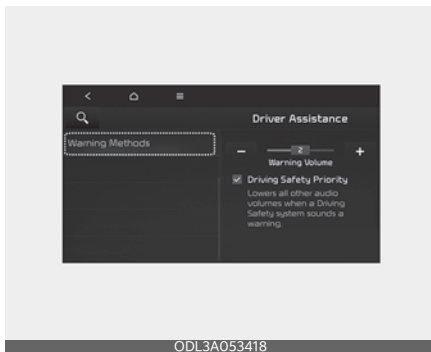

You can adjust the Warning Methods with the ignition switch or ENGINE START/ STOP button in the ON position.

- Parking Safety Priority: Select 'Settings → Vehicle → Driver Assistance → Warning Methods → Parking Safety Priority' on the Infotainment system for safe parking. For safe parking, the audio volume will temporarily decrease while Rear View Monitor is operating.

## \* NOTICE

- Ensure that Warning Methods you have set may apply to the warning volume of other driver assistance systems.
- If not equipped with the navigation system, select User Settings → Driver Assistance to adjust the Warning Volume.
- The settings menu content may vary depending of the vehicle specifications.
- Descriptions of each Driver Assistance system may be slightly different from the owner's manual after updating the software of your infotainment system. In this case, scan the QR code in the infotainment system manual to access the web manual to review the changes.
- Depending on region or system update, the menu may be displayed as 'Warning Sound' or 'Warning methods'.

## Rear view

### Operating conditions

- If the gear is shifted to R (Reverse), the rear view is displayed on the screen.

### Off conditions

- The rear view will not be turned off with the gear in R (Reverse).
- If pressing the Parking/View button (1) when the gear is in P (Parking) position with the video is displayed, the video will be turned off.

### Extended Rear View Monitor

- With the ENGINE START/STOP button in the ON position, select 'Setting → Screen → Keep Rear Camera' from the Settings menu in the Infotainment system.
- When parking, the rear view camera will remain on the screen if the following conditions are satisfied:
  - The gear is shifted from R (Reverse) to N (Neutral) or D (Drive)
  - Vehicle speed is below 6 mph (10 km/h)
- The rear view will turn off when vehicle speed is above 6 mph (10 km/h).
- The rear view will turn off when the Parking/View button (1) is pressed.
- If the gear is shifted to P (Park), the function is turned off.



## Top View



When you touch the icon (1), the top view is displayed on the screen and shows the distance from the vehicle behind you while parking.

### Rear View Monitor malfunction and limitations

#### Rear View Monitor Malfunction

When Rear View Monitor is not working properly, the screen is flickering, or the camera image does not display normally, have the function inspected by an authorized Kia dealer.

#### Limitations of Rear View Monitor

When the vehicle is stopped for a long time in winter or when the vehicle is parked in an indoor parking lot, the exhaust fumes may temporarily blur the image.

### ⚠ WARNING

- Never rely solely on Rear View Monitor. You must always use methods of viewing the area behind you, including looking over both shoulders as well as continuously checking all three rear view mirrors, as there are blind spots that may not appear on the camera. while backing up and parking.
- A wide-angle lens is used for Rear View Monitor. There may be a difference between actual object distance and visual object distance due to correction of the image distortion. Always pay attention to your surroundings for safety.
- There may be a distance difference from a real object. Always pay attention to your surroundings, safely.
- Parking guidelines may also be incorrect if the vehicle is tilted due to loading. For your own safety, check your surroundings.
- If the camera lens is covered with foreign material, Rear View Monitor may not operate normally. Always keep the camera lens clean.

However, do not use chemical solvents such as strong detergents containing high alkaline or volatile organic solvents (gasoline, acetone etc.). This may damage the camera lens.

## Surround View Monitor (SVM) (if equipped)



ODL3A042669

Surround View Monitor can assist with parking by allowing the driver to see around the vehicle.

\* For more detailed information, refer to a separately supplied Infotainment system manual.

### Detecting sensor



ODL3A013006

[1] : Wide-front view camera  
[2],[3] : Wide-side view camera



ODL3A051356

[4] : Wide-rear view camera  
Refer to the picture for the detailed location of the detecting sensors.

### Surround View Monitor settings

#### Camera setting



ODL3A042670

- You can change Surround View Monitor settings by pressing the setup icon (⚙️) on the screen while the function is operating, or select "Setup → Vehicle (Infotainment System screen) → Driver Assistance → Parking Safety → Camera Settings" from the Settings menu in the Settings in the Infotainment System screen while the ENGINE START/STOP button is in the ON position.

- You can change the settings of the following information:
  - Top View Parking Guide Lines
  - Rear View Parking Guide Lines
  - Parking distance warning
- You can change the following lists in the screen settings:
  - brightness (daytime)
  - brightness (nighttime)
  - contrast

### Top View Parking Guide Lines

Front top view



Rear top view



- If top view is selected, the top view will be displayed on the right side of top view in Surround View Monitor screen.

- The top view also works in pair with the front top view and rear top view guideline display.

### Rear View Parking Guide Lines



- If rear view is selected, the rear view will be displayed on the rear view screen.
- The horizontal guideline of the rear view shows the distance of 20 inches (0.5 m), 40 inches (1 m), 90 inches (2.3m) from the vehicle.

### Parking Distance Warning



- If warning is selected, the warning image will be displayed on the right side of top view in Surround View Monitor screen.

- The warning image appears only when the parking distance warning occurs.

## Surround View Monitor Auto On

- With the ENGINE START/STOP button is in the ON position, Surround View Monitor auto activation is activated or deactivated when you select 'Setup → Vehicle → Driver Assistance → Parking Safety → Surround View Monitor Auto On'.

## Warning Methods

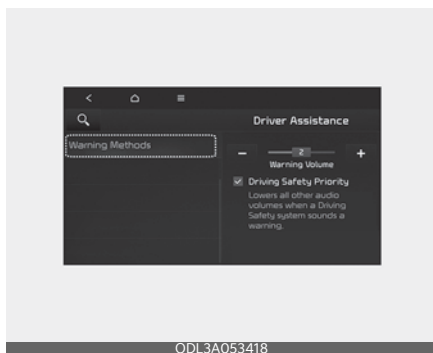

You can adjust the Warning Methods with the ignition switch or ENGINE START/ STOP button in the ON position.

- **Parking Safety Priority:** Select 'Settings → Vehicle → Driver Assistance → Warning Methods → Parking Safety Priority' on the Infotainment system for safe parking. For safe parking, the audio volume will temporarily decrease while Rear View Monitor is operating.

## \* NOTICE

- Ensure that Warning Methods you have set may apply to the warning volume of other driver assistance systems.
- If not equipped with the navigation system, select User Settings → Driver Assistance to adjust the Warning Volume.
- The settings menu content may vary depending of the vehicle specifications.
- Descriptions of each Driver Assistance system may be slightly different from the owner's manual after updating the software of your infotainment system. In this case, scan the QR code in the infotainment system manual to access the web manual to review the changes.
- Depending on region or system update, the menu may be displayed as 'Warning Sound' or 'Warning methods'.

## Surround View Monitor operation

### Surround View Monitor controller



ODL3A041667



ODL3A042674



ODL3049429

- Other view modes can be selected by touching the view icons (2) on Surround View Monitor screen.
- When one of the infotainment system buttons (3) is pressed without the gear in R (Reverse), Surround View Monitor will turn off.

### Front view

The function displays front view with the gear in N (Neutral) or D (Drive) to help you park safely. Front view contains top view/front view.

### Operating conditions

When the gear is shifted from R (Reverse) to N (Neutral) or D (Drive), the last set mode of front view function will be selected.

- Front view function will operate when the following conditions are satisfied:
  - While the infotainment system screen is being displayed, press the Parking/View button (1) briefly when the gear is in D (Drive) or N (Neutral) and vehicle speed is below 9 mph (15 km/h).
- Surround View Monitor Auto On will operate when the following conditions are satisfied:
  - With 'Driver Assistance → Parking Safety → Surround View Monitor Auto On' selected from the Settings menu, the front parking assist view screen is displayed when Parking Distance Warning warns the driver while in D (Drive).

- Press the Parking/View button (1) to turn on Surround View Monitor. Press the button again to turn off the function.

### Off conditions

- Press the Parking/View button (1) again, the image will turn off.
- When vehicle speed is above 9 mph (15 km/h) and the gear is in D (Drive), Surround View Monitor will be turned off and the screen will be changed to the infotainment system screen with Surround View Monitor. The screen will not revert to the surround view screen even though the vehicle speed is below 19 mph (15 km/h) again.
- Press one of the infotainment system button (3), the screen will change to the infotainment system screen.

### Rear view

The function displays rear view with the gear in N (Neutral) or D (Drive) to help you park safely. Rear view contains top view/rear view/side view.

### Operating conditions

- Shift the gear to R (Reverse), the image will appear on the screen.
- Press the Parking/View button (1) while the gear is in P (Park). The image will appear on the screen.

### Off conditions

- The image cannot be turned off when the gear is in R (Reverse).
- Shift the gear from R (Reverse) to P (Park). The image will turn off.
- Press the Parking/View button (1) again while the gear is in P (Park) with the image on the screen.

## Surround View Monitor malfunction and limitations

### Surround View Monitor malfunction

- When Surround View Monitor function is not working properly, or the screen flickers, or the camera image does not display normally, have the function inspected by an authorized Kia dealer.

### Limitations of Surround View Monitor

- When the vehicle is stopped for a long time in winter or when the vehicle is parked in an indoor parking lot, the exhaust fumes may temporarily blur the image.
- The screen may be displayed abnormally, and an icon will appear at the top left side of the screen under the following circumstances:
  - The trunk is opened
  - The driver or front passenger door is opened
  - The side view mirror is folded

### WARNING

- Surround View Monitor is a supplementary function. Make sure to check the vehicle's surroundings yourself for safety. Do not solely rely on what is displayed on the screen. What you see on the screen may differ from the actual vehicle's location.
- Parking guidelines may also be incorrect if the vehicle is tilted due to loading. For your own safety, check your surroundings.
- If the camera lens is covered with foreign material, Surround View Monitor may not operate normally. Always keep the camera lens clean. However,

do not use chemical solvents such as strong detergents containing high alkaline or volatile organic solvents (gasoline, acetone etc.). This may damage the camera lens.

- The Surround View Monitor is designed to provide optimal performance on flat terrain. However, on roads with variations in height such as curbs, speed bumps, etc., the screen connection may appear distorted or unnatural.
- 

## Reverse Parking Distance Warning (PDW) (if equipped)

Reverse Parking Distance Warning will warn the driver if an obstacle is detected when the vehicle is backing up at low speeds.

### **WARNING**

- Reverse Parking Distance Warning is a supplemental function. The operation of the function can be affected by several factors (including environmental conditions). It is the responsibility of the driver to always check the rear view before and while parking.
  - Pay close attention when driving near objects, pedestrians, and especially children.
  - Some objects may not be detected by the ultrasonic sensors due to the objects distance, size or material, all of which can limit the effectiveness of the sensor.
  - Your new vehicle warranty does not cover any accidents or damage to the vehicle or injuries to its occupants.
-

## Detecting sensor



[1] : Rear ultrasonic sensors

Refer to the picture for the detailed location of the rear ultrasonic sensors (1).

### ⚠ CAUTION

- Take the following precautions to maintain optimal performance of the detecting sensor:
  - Never disassemble the detecting sensors or sensor assembly, or apply any impact on it.
  - If the detecting sensors have been replaced or repaired, have the function inspected by an authorized Kia dealer.
- Reverse Parking Distance Warning may not operate normally when:
  - Moisture is frozen on the sensor
  - Sensor is covered with foreign matters, such as snow or water
- The function will operate normally when such foreign matter is removed.
- Reverse Parking Distance Warning may malfunction when:
  - Driving on uneven road, gravel roads or bushes
  - Objects that generate ultrasonic waves such as vehicle horns, loud motorcycle engine sound or truck air brakes are near the sensor
- Heavy rain or water spray is present
- Wireless transmitters or mobile phones are present near the sensor
- The sensor is covered with snow
- Affected by another vehicle's sensors
- Water flows on the surface of the sensor
- Installing the license plate differently from the original location
- Detecting range may decrease when:
  - Sensor is covered with foreign matter, such as snow or water
  - The weather is extremely hot or cold
- The function will operate normally when such foreign matters are removed.
- The following objects may not be detected:
  - Sharp or slim objects, such as ropes, chains or small poles
  - Objects, which tend to absorb sensor frequency, such as clothes, spongy material or snow
  - Objects smaller than 40 inches (1 m) in length and narrower than 6 inches (14 cm) in diameter



## Reverse Parking Distance Warning settings

### Warning Methods

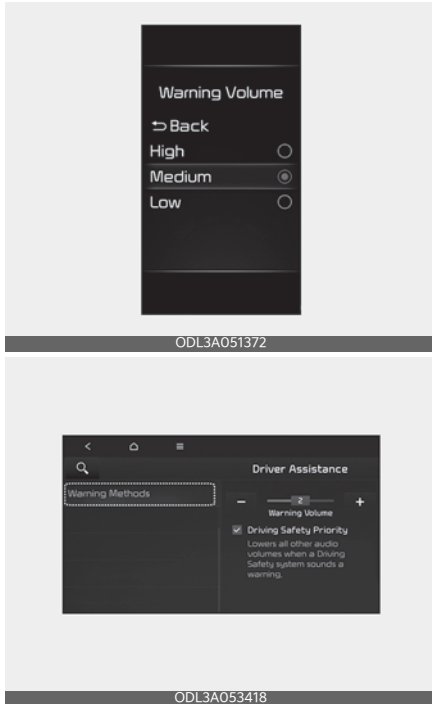

You can adjust the Warning Methods with the ignition switch or ENGINE START/ STOP button in the ON position.

- Warning Volume : Select 'User Settings → Driver Assistance → Warning Volume' on the instrument cluster or 'Settings → Vehicle → Driver Assistance → Warning Methods → Warning Volume' on the Infotainment system.

### \* NOTICE

- Ensure that Warning Methods you have set apply to the warning volume of other driver assistance systems.



- Warning Methods will maintain its last setting even if the vehicle is restarted.
- The setting menu may not be available for your vehicle depending on the vehicle features and specifications.
- The settings menu content may vary depending of the vehicle specifications.
- Descriptions of each driver assistance system may be slightly different from the owner's manual after updating the software of your infotainment system. In this case, scan the QR code in the infotainment system manual to access the web manual to review the changes.
- Depending on your update, the menu may be displayed as 'Warning Sound' or 'Warning methods'.

## Reverse Parking Distance Warning operation

### Operating conditions

- This function will activate when backing up with the ignition switch ON. If the vehicle is moving at a speed over 3 mph (5 km/h), the function may not be activated correctly.
- The sensing distance while Reverse Parking Distance Warning is in operation is approximately 47 inches (120 cm).
- When more than two objects are sensed at the same time, the closest one will be recognized first.

## Types of warning sound and indicator

Distance from object	Warning indicator	Warning sound
24~48 inches (60~120 cm)		Buzzer beeps intermittently
12~24 inches (30~60 cm)		Buzzer beeps frequently
within 12 inches (30 cm)		Buzzer beeps continuously

- The corresponding indicator will appear whenever each ultrasonic sensor detects an object in its sensing range.
- If an object is within 12 inches (30 cm) from the ultrasonic sensors, the sensors may not detect the object, or a sensor out of the detecting range may warn the driver.
- Distance warning may not occur sequentially depending on vehicle speed or obstacle shape.
- Indicators and warning sounds may differ from the illustration when obstacles are located in the center of the sensor, obstacles are located in close proximity to the vehicle, or in various circumstances.
- The shape of the indicator in the illustration may differ from the actual vehicle.

### Reverse Parking Distance Warning malfunction and precautions

#### Reverse Parking Distance Warning malfunction

Reverse Parking Distance Warning has a self-diagnosis function that can deter-

mine whether the ultrasonic sensor is working properly. After starting the engine, a beep will sound when the gear is shifted to P (Park) to indicate the function is operating normally.

However, if one or more of the following occurs, first check whether the ultrasonic sensor is damaged or whether the function is in a non-operating condition. If it still does not work properly, have the function inspected by an authorized Kia dealer.

- The audible warning does not sound.
- The buzzer sounds intermittently.
- The 'Parking sensor error or blockage' warning message appears on the cluster.



#### Reverse Parking Distance Warning precautions

Reverse Parking Distance Warning may malfunction if the vehicle bumper height or ultrasonic sensor installation has been modified or damaged. Any non-factory installed equipment or accessories may also interfere with the sensor performance.

When the ultrasonic sensor is frozen or stained with snow, dirt, or water, the sensor may not operate until the stains are removed using a soft cloth.

Do not push, scratch or strike the ultrasonic sensor. Sensor damage could occur.

Do not spray the ultrasonic sensors or its surrounding area directly with a high pressure washer.

### Forward/Reverse Parking Distance Warning (PDW) (if equipped)

Forward/Reverse Parking Distance Warning will warn the driver by warning indicator or sound if person, animal, or object in certain range is detected from the front/rear ultrasonic sensors (1) when the vehicle is moving forward or backward at low speeds.

### Detecting sensor

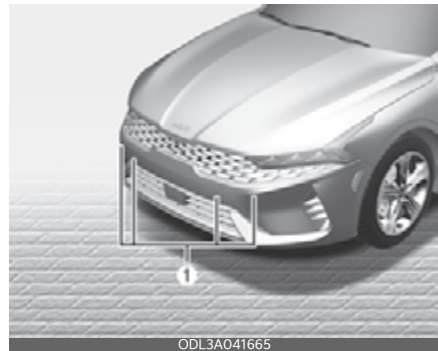

[1]: Front ultrasonic sensors

[2]: Rear ultrasonic sensors

Refer to the picture for the detailed location of the detecting sensor.

## Forward/Reverse Parking Distance Warning settings

### Reverse Parking Distance Warning settings

#### Warning Methods

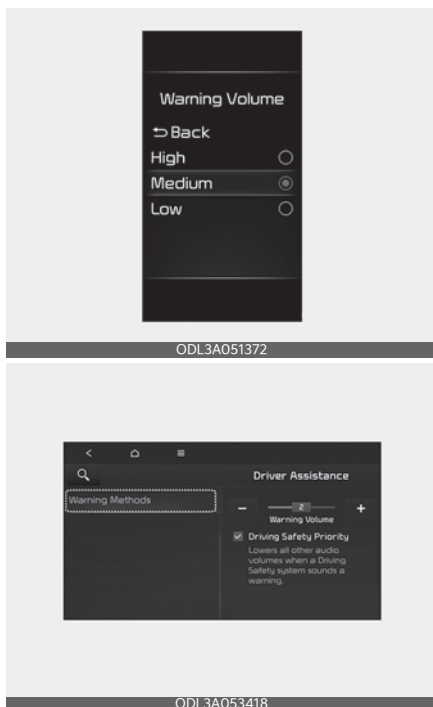

You can adjust the Warning Methods with the ignition switch or ENGINE START/ STOP button in the ON position.

- Warning Volume : Select 'User Settings → Driver Assistance → Warning Volume' on the instrument cluster or 'Settings → Vehicle → Driver Assistance → Warning Methods → Warning Volume' on the Infotainment system.

#### \* NOTICE

- Ensure that Warning Methods you have set may apply to the warning volume of other driver assistance systems.
- Warning Methods will maintain its last setting even if the vehicle is restarted.
- The setting menu may not be available for your vehicle depending on the vehicle features and specifications.
- The settings menu content may vary depending of the vehicle specifications.
- Descriptions of each driver assistance system may be slightly different from the owner's manual after updating the software of your infotainment system. In this case, scan the QR code in the infotainment system manual to access the web manual to review the changes.
- Depending on your update, the menu may be displayed as 'Warning Sound' or 'Warning methods'.

#### "Parking Distance Warning Auto On" Setting



- Parking Distance Warning Auto On is activated or deactivated when you select 'Setup → Vehicle (Infotainment System screen) → Driver Assistance → Parking Safety → Parking Distance Warning Auto On'.

## Forward/Reverse Parking Distance Warning operation

### Parking Safety button





ODL3049073L

- Press Parking Safety button (P  ) to turn the function on and off.
- When the function is off (button indicator light off), if you shift the gear to R (Reverse), the function will automatically turn on.
- Parking Safety (P  ) button indicator light will appear when the function operates. When the vehicle speed exceeds 19 mph (30 km/h), the function will turn off and the button indicator light will not appear.
- When the gear is shifted to R (Reverse), even if the button is repressed, the button indicator light will not turn off and the function will operate to assist safe parking.

### Forward Parking Distance Warning

- Forward Parking Distance Warning activates in following 3 conditions:
  1. The vehicle is changed from R (Reverse) to D (Drive) when Forward/Reverse Parking Distance Warning is activated

2. The vehicle is in D (Drive) position and PDW indicator is appeared
  3. The gear is changed at D (Drive) position while 'Parking Distance Warning Auto ON' is selected
- Forward/Reverse Parking Distance Warning assists the driver during movement of the vehicle by chiming if any person, animal or object is sensed while the speed of your vehicle is below 6 mph (10 km/h).
  - The function will not send a warning for an obstacle if the speed of your vehicle exceeds 6 mph (10 km/h). The warning function will be activated again when the speed drops below 6 mph (10 km/h).
  - If you select 'Parking Distance Warning Auto ON' on the cluster or from the menu of the infotainment system, the indicator light will be kept on.
  - If vehicle speed exceeds 19 mph (30 km/h) when 'Parking Distance Warning Auto ON' is deselected, the indicator will turn off. If the vehicle speed is below 6 mph (10 km/h), the function will not warn you.



Distance from object	Warning indicator	
	When driving forward	Warning sound
24~40 inches (60~100 cm)		Buzzer beeps intermittently
12~24 inches (30~60 cm)		Buzzer beeps frequently
within 12 inches (30 cm)		Buzzer beeps continuously

## Driver assistance system

- When people, animal, or objects are detected, it is displayed on the cluster or infotainment system screen with an audible warning.
- When more than two people, animal, or objects are detected at the same time, the closest one will be warned with an audible warning.
- The shape of the indicator in the illustration may differ from the actual vehicle.

## Reverse Parking Distance Warning

- Reverse Parking Distance Warning activates when the gear is in R (Reverse) position.
- Reverse Parking Distance Warning assists the driver during reverse movement of the vehicle by chiming if any people, animal, or object is sensed when the vehicle speed is below 6 mph (10 km/h).
- The rear and front side sensors warn the driver when moving backward when the vehicle speed is below 6 mph (10 km/h). However, the object must be within 24 inches (60 cm) from the front-side sensors to operate.

Distance from object	Warning indicator When driving backward	Warning sound
24~48 inches (60 ~120 cm)		Buzzer beeps intermittently
12~24 inches (30~60 cm)		Buzzer beeps frequently
within 12 inches (30 cm)		Buzzer beeps continuously

## Forward/Reverse Parking Distance Warning (PDW)

- When people, animal, or objects are detected, it is displayed on the cluster or infotainment system screen with an audible warning.
- When more than two people, animal, or objects are detected at the same time, the closest one will be alerted with an audible warning.
- The shape of the indicator in the illustration may differ from the actual vehicle.

## Forward/Reverse Parking Distance Warning malfunction and limitations

### Forward/Reverse Parking Distance Warning malfunction

After starting the engine, a beep will sound when the gear is shifted to R (Reverse) to indicate the function is operating normally.

However, if one or more of the following occurs, first check whether the ultrasonic sensor is damaged or whether the function is in a non-operating condition. If it still does not work properly, have the function inspected by an authorized Kia dealer.

- The audible warning does not sound.
- The buzzer sounds intermittently.
- The 'Parking sensor error of blockage' warning message appears on the cluster.



### **⚠ WARNING**

- Always look around your vehicle to make sure there are no objects or obstacles before moving the vehicle in any direction to prevent a collision.
  - Your new vehicle warranty does not cover any accidents or damage to the vehicle or injuries to its occupants related to a Reverse Parking Distance Warning.
  - Always pay close attention when the vehicle is driven close to objects, particularly pedestrians, and especially children. Be aware that some objects may not be visible on the screen or be detected by the sensors, due to the objects distance, size or material, all of which can limit the effectiveness of the sensor.
  - Forward/Reverse Parking Distance Warning may not operate normally when:
    - Moisture is frozen to the sensor. (It will operate normally when the ice melts.)
    - Sensor is covered with foreign matter, such as snow or water, or the sensor cover is blocked. (It will operate normally when the material is removed or the sensor is no longer blocked.)
- Outside air temperature is extremely hot or cold.
  - Radar components are arbitrarily removed.
  - The sensor is pushed, scratched or struck with any hard and sharp objects that could damage the surface.
  - High pressure water is directly applied to ultrasonic sensor.
  - Heavy rain or water spray is present.
  - Wireless transmitters or mobile phones present near the sensor.
  - Heavy rain or water spray is present.
  - Driving on uneven road surfaces such as unpaved roads, gravel, bumps, or gradient.
  - Wireless transmitters or mobile phones present near the sensor.
  - Accessories, such as license plate molding or sticker, are installed on the sensor area.
  - The vehicle bumper height or sensor installation has been modified.
  - Any non-factory equipment or accessories have been installed.
- The following objects may not be recognized by the sensor:
    - Sharp or slim objects such as ropes, chains or small poles.
    - Undetectable objects smaller than 40 inches (100 cm) and narrower than 5.5 inches (14 cm) in diameter.
    - Objects, which tend to absorb sensor frequency such as clothes, spongy material or snow.
    - People, animal or objects located very close to the sensor

- The indicator may operate differently when the people, animal or obstacle is located between sensors.
  - Parking Distance Warning may not occur sequentially depending on vehicle speed or obstacle shape.
  - If it does not work properly, have your vehicle inspected by an authorized Kia dealer.
- 

## Rear Cross-Traffic Collision-Avoidance Assist (RCCA) (if equipped)

Rear Cross-Traffic Collision-Avoidance Assist is designed to help detect vehicles approaching from the left and right side while your vehicle is reversing, and warn the driver that a collision is imminent with a warning message and an audible warning. Braking is assisted to help prevent collision.

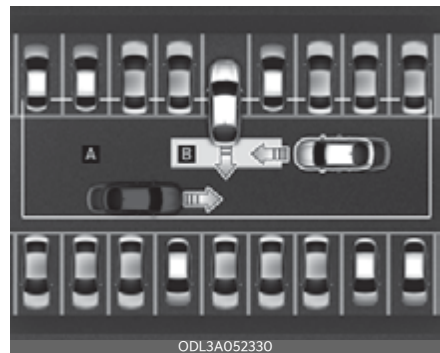

[A]: Rear Cross-Traffic Collision Warning operating range,

[B]: Rear Cross-Traffic Collision-Avoidance Assist operating range

### **⚠ CAUTION**

The time of warning may vary depending on vehicle speed of the approaching vehicle.

---



### Detecting sensor



[1]: Rear corner radar

Refer to the picture for the detailed location of the detecting sensors.

#### **CAUTION**

For more details on the precautions of the rear corner radar, refer to "Blind-Spot Collision-Avoidance Assist (BCA) (if equipped)" on page 6-37.

### Rear Cross-Traffic Collision-Avoidance Assist settings

#### Rear Cross-Traffic Safety

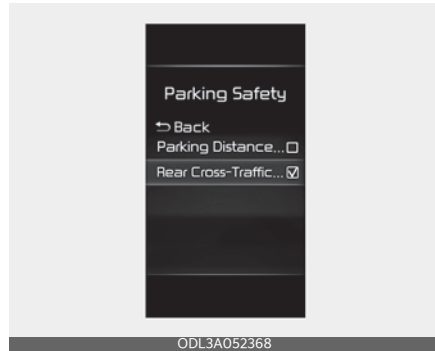

ODL3A052368

With the ENGINE START/STOP button in the ON position, select 'Driver Assistance → Parking Safety → Rear Cross-Traffic Safety' from the Settings menu to turn on Rear Cross-Traffic Collision-Avoidance Assist and deselect to turn off the function.

#### **WARNING**

When the engine is restarted, Rear Cross-Traffic Safety will always turn on. However, if 'Off' is selected after the engine is restarted, the driver should always be aware of the surroundings and drive safely.

#### **NOTICE**

Settings for Rear Cross-Traffic Safety include Rear Cross-Traffic Collision Warning and Rear Cross-Traffic Collision-Avoidance Assist.

**\* NOTICE**

If the engine is restarted, Warning Timing and Warning Volume will maintain the last setting.

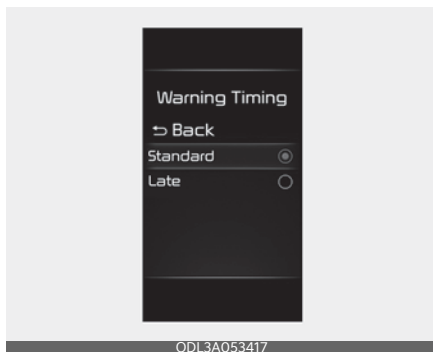
**Warning Timing**

With the ENGINE START/STOP button in the ON position, select 'Driver Assistance → Warning Timing' from the Settings menu to change the initial warning activation time for Rear Cross-Traffic Collision-Avoidance Assist.

When the vehicle is first delivered, Warning Timing is set to 'Standard'. If you change the Warning Timing, the warning time of other Driver Assistance systems may change.

**\* NOTICE**

- The setting of the Warning Timing applies to all functions of the Rear Collision-Avoidance Assist.
- Even though 'Standard' is selected for Warning Timing, if the vehicles from the left and right side approaches at high speed, the initial warning activation time may seem late.
- Select 'Late' for Warning Timing when traffic is light and when driving speed is slow.

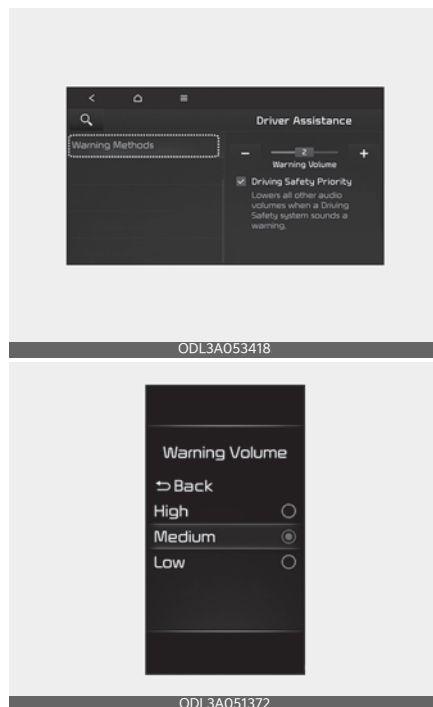
**Warning Methods**

You can adjust the Warning Methods with the ignition switch or ENGINE START/ STOP button in the ON position.

- Warning Volume : Select 'User Settings → Driver Assistance → Warning Volume' on the instrument cluster or 'Settings → Vehicle → Driver Assistance → Warning Methods → Warning Volume' on the Infotainment system.

**\* NOTICE**

- Ensure that Warning Methods you have set may apply to the warning volume of other driver assistance systems.
- Warning Methods will maintain its last setting even if the vehicle is restarted.

- The setting menu may not be available for your vehicle depending on the vehicle features and specifications.
  - Descriptions of each driver assistance system may be slightly different from the owner's manual after updating the software of your infotainment system. In this case, scan the QR code in the infotainment system manual to access the web manual to review the changes.
  - Depending on your update, the menu may be displayed as 'Warning Sound' or 'Warning methods'.
- 

## Rear Cross-Traffic Collision-Avoidance Assist operation

### Warning and control

Rear Cross-Traffic Collision-Avoidance Assist will warn and control the vehicle depending on collision level: 'Collision Warning', 'Emergency Braking' and 'Stopping vehicle and ending brake control'.

### Collision Warning

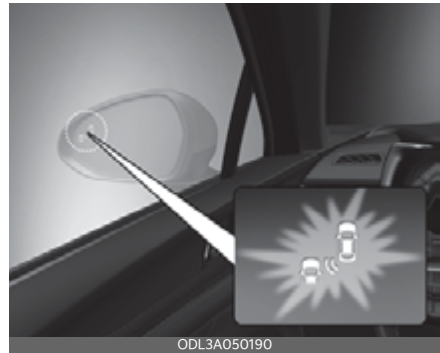



- To warn the driver of an approaching vehicle from the rear left/right side of your vehicle, the warning light on the side view mirror will blink and a warning will appear on the cluster. At the same time, an audible warning will sound. If Rear View Monitor is operating, a warning will also appear on the infotainment system screen (if equipped)
- Rear Cross-Traffic Collision-Avoidance Assist will operate when all the following conditions are satisfied:
  - The gear is shifted to R (Reverse)
  - Vehicle speed is below 5 mph (8 km/h)
  - The approaching vehicle is within approximately 82 ft. (25 m) from the left and right side of your vehicle
  - The speed of the vehicle approaching from the left and right is above 3 mph (5 km/h)

**\* NOTICE**

If the operating conditions are satisfied, there will be a warning whenever the vehicle approaches from the left or right side even though your driving speed is 0 mph (0 km/h).

**Emergency Braking**

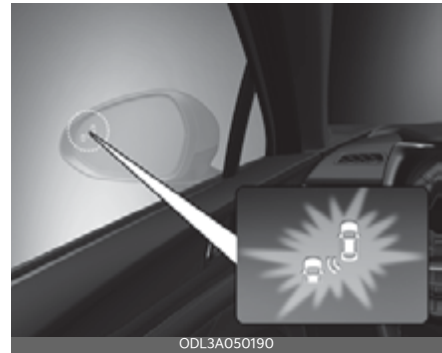

- To warn the driver of an approaching vehicle from the rear left/right side of your vehicle, the warning light on the side view mirror will blink and a warning message will appear on the cluster. At the same time, an audible warning will sound. If Rear View Moni-

for is operating, a warning will also appear on the infotainment system screen.

- Rear Cross-Traffic Collision-Avoidance Assist will operate when all the following conditions are satisfied:
  - The gear is shifted to R (Reverse)
  - Vehicle speed is below 5 mph (8 km/h)
  - The approaching vehicle is within approximately 5 ft. (1.5 m) from the left and right side of your vehicle
  - The speed of the vehicle approaching from the left and right is above 3 mph (5 km/h)
- Emergency braking will be assisted to help prevent collision with approaching vehicles from the left and right.

### **⚠ WARNING**

Brake control will end when:

- The approaching vehicle is out of the detecting range
- The approaching vehicle passes behind your vehicle
- The approaching vehicle does not drive toward your vehicle
- The approaching vehicle speed slows down
- The driver depresses the brake pedal with sufficient power

## Stopping vehicle and ending brake control



- When the vehicle is stopped due to emergency braking, the 'Drive carefully' warning message will appear on the cluster.
- For your safety, the driver should depress the brake pedal immediately and check the surroundings.
- Brake control will end after the vehicle is stopped by emergency braking for approximately 2 seconds.
- During emergency braking, braking control by Rear Cross-Traffic Collision-Avoidance Assist will automatically cancel when the driver excessively depresses the brake pedal.

### **⚠ WARNING**

Take the following precautions when using Rear Cross-Traffic Collision-Avoidance Assist:

- For your safety, change the Settings after parking the vehicle at a safe location.
- If any other function's warning message is displayed or audible warning is generated, Rear Cross-Traffic Collision-Avoidance Assist's warning message may not be displayed and

audible warning may not be generated.

- You may not hear the warning sound of Rear Cross-Traffic Collision-Avoidance Assist if the surrounding is noisy.
- Rear Cross-Traffic Collision-Avoidance Assist may not operate if the driver applies the brake pedal to avoid collision.
- During Rear Cross-Traffic Collision-Avoidance Assist operation, the vehicle may stop suddenly, injuring passengers and shifting loose objects. Always have the seat belt on and keep loose objects secured.
- Even if there is a problem with Rear Cross-Traffic Collision-Avoidance Assist, the vehicle's basic braking performance will operate normally.
- Rear Cross-Traffic Collision-Avoidance Assist does not operate in all situations, or cannot avoid all collisions.
- During emergency braking, braking control by Rear Cross-Traffic Collision-Avoidance Assist will automatically cancel when the driver excessively depresses the accelerator pedal.
- Rear Cross-Traffic Collision-Avoidance Assist may not operate properly, or may operate unnecessarily, depending on the road conditions and the surroundings.
- The driver should hold the responsibility to control the vehicle. Do not solely depend on Rear Cross-Traffic Collision-Avoidance Assist. Rather, maintain a safe braking distance, and if necessary, depress the brake pedal to reduce driving speed or to stop the vehicle.
- Never deliberately operate Rear Cross-Traffic Collision-Avoidance

Assist on people, animal, objects, etc. It may cause serious injury or death.

### CAUTION

The brake control may not operate properly depending on the status of ESC (Electronic Stability Control).

There will only be a warning when:

- The ESC (Electronic Stability Control) warning light is on
- ESC (Electronic Stability Control) is engaged in a different function

### NOTICE

- If braking is assisted by Rear Cross-Traffic Collision-Avoidance Assist, the driver must immediately depress the brake pedal and check vehicle surroundings.
- Brake control will end when the driver depresses the brake pedal with sufficient power.
- After shifting the gear to R (Reverse), braking control will operate once a vehicle from the left or right approaches.

### Rear Cross-Traffic Collision-Avoidance Assist malfunction and limitations

#### Rear Cross-Traffic Collision-Avoidance Assist malfunction

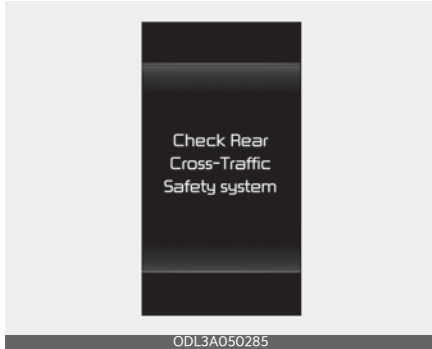

When Rear Cross-Traffic Collision-Avoidance Assist is not working properly, the 'Check Rear Cross-Traffic Safety system' warning message will appear on the cluster, and Rear Cross-Traffic Collision-Avoidance Assist will turn off automatically or it will be limited. In this case, have your vehicle inspected by an authorized Kia dealer.

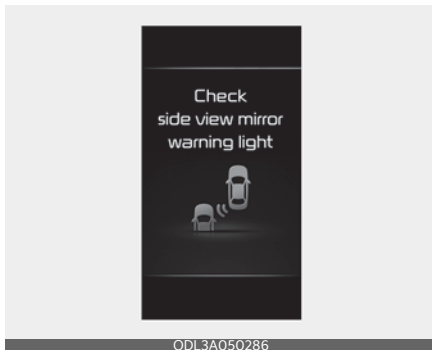

When the side view mirror warning light is not working properly, the 'Check side view mirror warning light' warning message will appear on the cluster. In this

case, have your vehicle inspected by an authorized Kia dealer.

#### Rear Cross-Traffic Collision-Avoidance Assist disabled

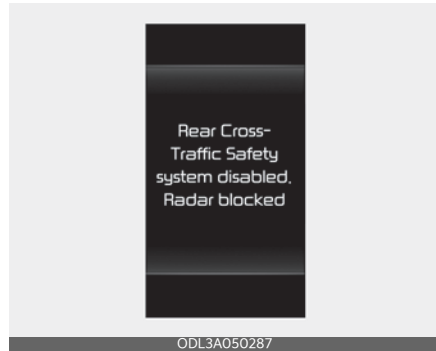

When the rear bumper around the rear-side radar or sensor is covered with foreign material, such as snow or rain, or towing a trailer or carrier, it can reduce the detecting performance and temporarily limit or disable Rear Cross-Traffic Collision-Avoidance Assist.

If this occurs, the 'Rear Cross-Traffic Safety system disabled. Radar blocked' warning message will appear on the cluster.

Rear Cross-Traffic Collision-Avoidance Assist will operate normally once foreign material, trailer, etc. is removed. Always keep the radar clean.

If Rear Cross-Traffic Collision-Avoidance Assist does not operate normally after it is removed, have the function be inspected by an authorized Kia dealer.

#### **⚠ WARNING**

- Even though the warning message does not appear on the cluster, Rear Cross-Traffic Collision-Avoidance Assist may not operate properly.
- Rear Cross-Traffic Collision-Avoidance Assist may not operate properly

in an area (for example: open terrain), where any substance are not detected after turning ON the engine.

**CAUTION**

Turn off Rear Cross-Traffic Collision-Avoidance Assist to towing a trailer, carrier, etc., or remove the trailer, carrier, etc. to use Rear Cross-Traffic Collision-Avoidance Assist.

**Limitations of Rear Cross-Traffic Collision-Avoidance Assist**

Rear Cross-Traffic Collision-Avoidance Assist may not operate normally, or the system may operate unexpectedly under the following circumstances:

- Departing from where trees or grass are overgrown
- Departing from where roads are wet
- Speed of the approaching vehicle is fast or slow

Driver's attention is required when Braking Control may not be working properly due to the following circumstances:

- The vehicle severely vibrates while driving over a bumpy road, uneven road, or a rough concrete patch.
- Driving on a slippery surface due to snow, water puddle, ice, etc.
- The tire pressure is low or a tire is damaged
- The brake is reworked

**CAUTION**

For more details on the limitations of the rear corner radar, refer to "Blind-Spot Collision-Avoidance Assist (BCA) (if equipped)" on page 6-37.

**WARNING**

- Driving near a vehicle or structure

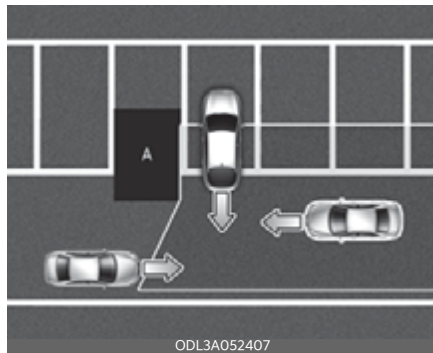

[A]: Structure

Rear Cross-Traffic Collision-Avoidance Assist may be limited when driving near a vehicle or structure, and may not detect the vehicle approaching from the left or right. If this occurs, the function may not warn the driver or control the brakes when necessary.

Always check your surroundings while backing up.

- When the vehicle is in a complex parking environment



Rear Cross-Traffic Collision-Avoidance Assist may detect vehicles which are parking or pulling out near your vehicle (for example: a vehicle leaving beside



your vehicle, a vehicle parking or pulling out in the rear area, a vehicle approaching your vehicle making a turn, etc.). If this occurs, the function may unnecessarily warn the driver and control the brake.

Always check your surroundings while backing up.

- When the vehicle is parked diagonally

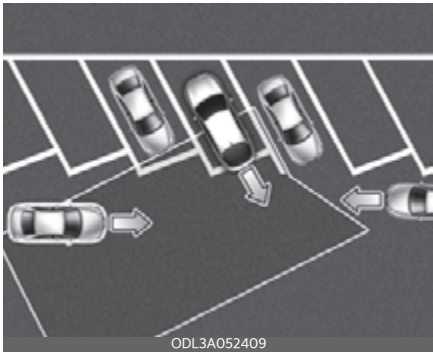

Rear Cross-Traffic Collision-Avoidance Assist may be limited, and may not detect the vehicle approaching from the left or right. If this occurs, the function may not warn the driver, or control the brakes when necessary. Always check your surroundings while backing up. Always check your surroundings while backing up.

- When the vehicle is on or near a slope

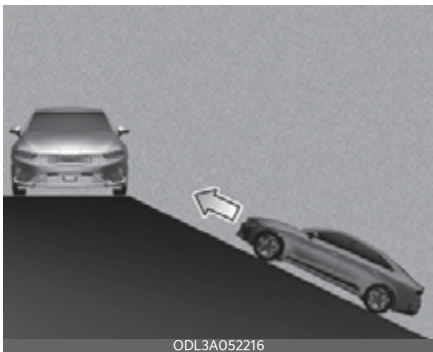

Rear Cross-Traffic Collision-Avoidance Assist may be limited when the vehicle is on, or near, a uphill or downhill slope, and may not detect the vehicle approaching from the left or right. If this occurs, the function may not warn the driver or control the brakes when necessary.

Always check your surroundings while backing up.

- Pulling into the parking space where there is a structure

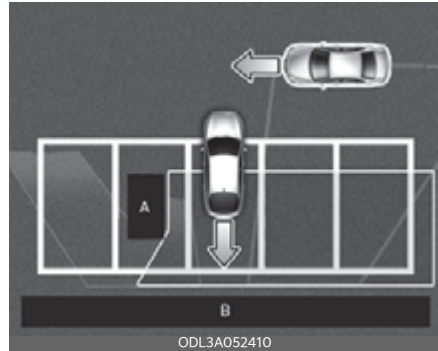

[A]: Structure, [B]: Wall

Rear Cross-Traffic Collision-Avoidance Assist may detect vehicles passing by in front of you when parking backwards into a parking space with a wall or structure in the rear or side area. If this occurs, the function may unnecessarily warn the driver and control the brake. Always check your surroundings while backing up.

- When the vehicle is parked rearward

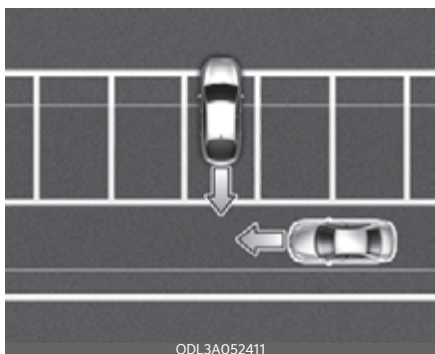

Rear Cross-Traffic Collision-Avoidance Assist may detect vehicles passing by behind you when parking backwards into a parking space. If this occurs, the function may unnecessarily warn the driver and control the brake.

Always check your surroundings while backing up.

### **⚠ WARNING**

- When you are towing a trailer or another vehicle, we recommend that Rear Cross-Traffic Collision-Avoidance Assist is turned off due to safety reasons.
- Rear Cross-Traffic Collision-Avoidance Assist may not operate normally if interfered by strong electromagnetic waves.
- Rear Cross-Traffic Collision-Avoidance Assist may not operate for approximately 3 seconds after the vehicle is started, or the rear corner radars are initialized.

### **This device complies with Part 15 of the FCC rules.**

Operation is subject to the following three conditions:

1. This device may not cause harmful interference, and
2. This device must accept any interference received, including interference that may cause undesired operation.

## Reverse Parking Collision-Avoidance Assist (PCA) (if equipped)

Reverse Parking Collision-Avoidance Assist may warn the driver or may assist with braking to help reduce the possibility of collision with pedestrians or obstacles when backing up.

### Detecting sensor



[1] : Wide-rear view camera [2] : Rear ultrasonic sensors

Refer to the picture for the detailed location of the detecting sensors.

## Reverse Parking Collision- Avoidance Assist settings

### Parking Safety

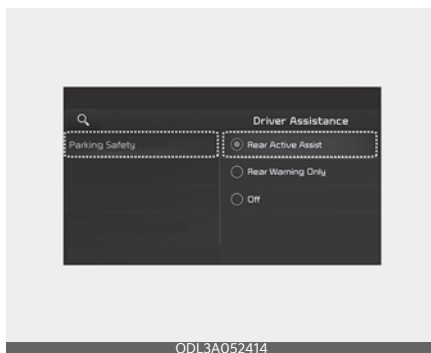

With the ENGINE START/STOP button in the ON position, select or deselect 'Driver Assistance → Parking Safety' from the Settings menu to set whether or not to use the function.

- If 'Rear Active Assist' is selected, Reverse Parking Collision-Avoidance Assist will warn the driver and assist with braking when a collision with a pedestrian or an object is imminent.
- If 'Rear Warning Only' is selected, Reverse Parking Collision-Avoidance Assist will warn the driver when a collision with a pedestrian or an object is imminent. Braking will not be assisted.
- If 'Off' is selected, Reverse Parking Collision-Avoidance Assist will turn off.

## Warning Timing

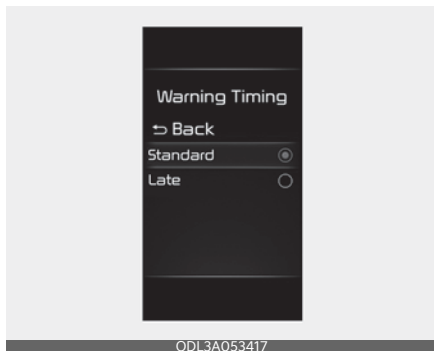

With the ENGINE START/STOP button in the ON position, select 'Driver Assistance → Warning Timing' from the Settings menu to change the initial warning activation time for Reverse Parking Collision-Avoidance Assist.

When the vehicle is first delivered, Warning Timing is set to 'Normal'. If you change the Warning Timing, the warning time of other Driver Assistance systems may change.

## Warning Methods

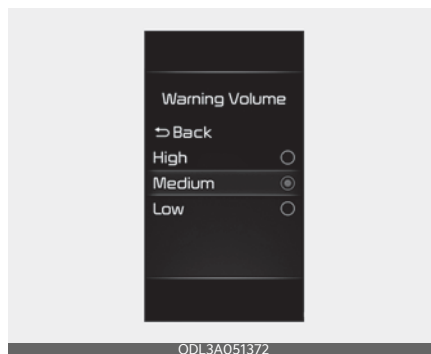
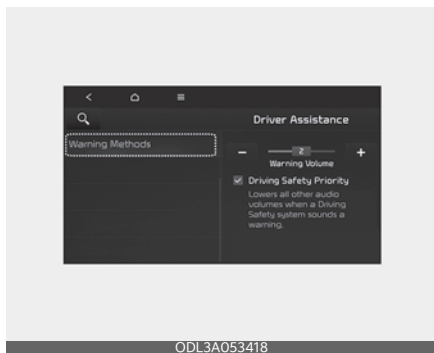

You can adjust the Warning Methods with the ignition switch or ENGINE START/ STOP button in the ON position.

- Warning Volume : Select 'User Settings → Driver Assistance → Warning Volume' on the instrument cluster or 'Settings → Vehicle → Driver Assistance → Warning Methods → Warning Volume' on the Infotainment system.

### \* NOTICE

- Ensure that Warning Methods you have set may apply to the warning volume of other driver assistance systems.
- Warning Methods will maintain its last setting even if the vehicle is restarted.
- The setting menu may not be available for your vehicle depending on the vehicle features and specifications.
- Descriptions of each driver assistance system may be slightly different from the owner's manual after updating the software of your infotainment system. In this case, scan the QR code in the infotainment system manual to access the web manual to review the changes.

- Depending on your update, the menu may be displayed as 'Warning Sound' or 'Warning methods'.

## Reverse Parking Collision- Avoidance Assist operation

### Operating conditions

If 'Rear Active Assist' or 'Rear Warning Only' is set from the Settings menu, Reverse Parking Collision-Avoidance Assist will be in the ready status when the following conditions are satisfied:

- The trunk is closed
- The gear is shifted to R (Reverse)
- Vehicle speed is below 6 mph (10 km/h)
- Reverse Parking Collision-Avoidance Assist components such as the wide-rear view camera and the rear ultrasonic sensors are in normal conditions

The solid lines behind the vehicle in the cluster LCD display indicates that Reverse Parking Collision-Avoidance Assist is ready to assist the driver.

Note that Reverse Parking Collision-Avoidance Assist assists the driver only once.

The driver has to shift the gear to R (Reverse) from another gear position to reactivate Reverse Parking Collision-Avoidance Assist.

### Rear Active Assist

- If Reverse Parking Collision-Avoidance Assist detects a risk of collision with a pedestrian or an object, Reverse Parking Collision-Avoidance Assist will warn the driver with an audible warning, steering wheel vibration and warning message on the cluster. When Rear View Monitor is

operating, a warning will appear on the infotainment system screen.

- If Reverse Parking Collision-Avoidance Assist detects imminent collision with a pedestrian or an object behind the vehicle, Reverse Parking Collision-Avoidance Assist may assist you with braking. The driver needs to pay attention as the brake assist will end within 2 seconds. The driver must immediately depress the brake pedal and check vehicle surroundings.
- Brake control will end when:
  - The gear is shifted to P (Park) or D (Drive).
  - The driver depresses the brake pedal with sufficient power
  - Braking assist last for approximately 2 seconds
- The warning will turn off when:
  - The driver shifts the gear to P (Park), N (Neutral), or D (Drive)
- The brake control may not operate properly depending on the status of ESC (Electronic Stability Control). There will only be a warning when:
  - The ESC (Electronic Stability Control) warning light is on
  - ESC (Electronic Stability Control) is engaged in a different function

### Rear Warning Only

- If Reverse Parking Collision-Avoidance Assist detects a risk of collision with a pedestrian or an object, Reverse Parking Collision-Avoidance Assist will warn the driver with an audible warning, steering wheel vibration and warning message on the cluster. When Rear View Monitor is operating, a warning will appear on the infotainment system screen.

- If 'Warning Only' is selected, braking will not be assisted.
- The warning will turn off when the gear is shifted to P (Park), N (Neutral) or D (Drive).

**⚠ WARNING**

- Reverse Parking Collision-Avoidance Assist may not operate properly or may operate unnecessarily depending on the road conditions and the surroundings.
- Always pay extreme caution while driving. The driver is responsible for controlling the brake for safe driving.
- Always pay attention to road and traffic conditions while driving, whether or not there is a warning.

**⚠ CAUTION**

- Playing the vehicle audio system at high volume may prevent passengers from hearing Reverse Parking Collision-Avoidance Assist warning sounds.
- Noise may be heard when sudden braking occurs to avoid a collision.
- If any other warning sound such as the seat belt warning chime is already generated, Reverse Parking Collision-Avoidance Assist warning may not sound.
- The performance of Reverse Parking Collision-Avoidance Assist may vary under certain conditions. If vehicle speed is above 2 mph (4 km/h), Reverse Parking Collision-Avoidance Assist will provide collision avoidance assist only when pedestrians are detected. Always look around and pay attention when backing up your vehicle.

**\* NOTICE**

Reverse Parking Collision-Avoidance Assist can detect a pedestrian or an object when:

- A pedestrian is standing behind the vehicle
- A large obstacle, such as a vehicle, is parked in the rear center of your vehicle

**Reverse Parking Collision-Avoidance Assist malfunction and limitations**

**Reverse Parking Collision-Avoidance Assist malfunction**

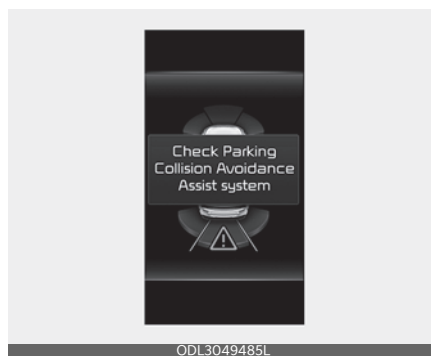

When Reverse Parking Collision-Avoidance Assist or other related functions are not working properly, the 'Check Parking Collision-Avoidance Assist system' warning message will appear on the cluster, and Reverse Parking Collision-Avoidance Assist will turn off automatically. In this case, have your vehicle inspected by an authorized Kia dealer.

### Reverse Parking Collision-Avoidance Assist disabled



The wide-rear view camera (1) is used as a detecting sensor to detect pedestrians. If the camera lens is covered with foreign material, such as snow or rain, it may adversely affect camera performance and Reverse Parking Collision-Avoidance Assist may not operate normally. Always keep the camera lens clean.



The rear ultrasonic sensors (2) are located inside the rear bumper to detect objects in the rear area. If the sensors are covered with foreign material, such as snow or rain, it may adversely affect sensor performance and Reverse Parking Collision-Avoidance Assist may not

operate normally. Always keep the rear bumper clean.

#### Wide-rear view camera



#### Rear ultrasonic sensor

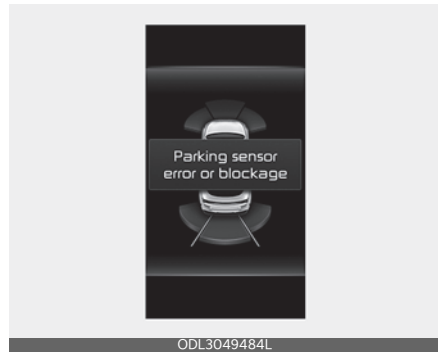

The 'Rear camera error or blockage' or 'Parking sensor error or blockage' warning message will appear on the cluster if the following situations occur:

- The wide-rear view camera is covered with foreign material, such as snow or rain, etc.
- There is inclement weather, such as heavy snow, heavy rain, etc.

If this occurs, Reverse Parking Collision-Avoidance Assist may turn off or may not operate properly. Check whether the wide-rear view camera and rear ultrasonic sensors are clean.

## Limitations of Reverse Parking Collision-Avoidance Assist

Reverse Parking Collision-Avoidance Assist may not assist braking or warn the driver even if there are pedestrians or objects under the following circumstances:

- Any non-factory equipment or accessory is installed
- Your vehicle is unstable due to an accident or other causes
- Bumper height or rear ultrasonic sensor installation has been modified
- Wide-rear view camera or rear ultrasonic sensor(s) is damaged
- Wide-rear view camera or the rear ultrasonic sensor(s) is stained with foreign matter, such as snow, dirt, etc.
- Wide-rear view camera is obscured by a light source or by inclement weather, such as heavy rain, fog, snow, etc.
- The surrounding is very bright or very dark
- Outside temperature is very high or very low
- The wind is either strong (above 12 mph (20 km/h)) or blowing perpendicular to the rear bumper
- Objects generating excessive noise, such as vehicle horns, loud motorcycle engines or truck air brakes, are near your vehicle
- An ultrasonic sensor with similar frequency is near your vehicle
- There is ground height difference between the vehicle and the pedestrian
- The image of the pedestrian in the wide-rear view camera is indistinguishable from the background
- The pedestrian is near the rear edge of the vehicle
- The pedestrian is not standing upright
- The pedestrian is either very short or very tall for the function to detect
- The pedestrian or cyclist is wearing clothing that easily blends into the background, making it difficult to detect
- The pedestrian is wearing clothing that does not reflect ultrasonic waves well
- Size, thickness, height, or shape of the object does not reflect ultrasonic waves well (e.g., pole, bush, curbs, carts, edge of a wall, etc.)
- The pedestrian or the object is moving
- The pedestrian or the object is very close to the rear of the vehicle
- A wall is behind the pedestrian or the object
- The object is not located at the rear center of your vehicle
- The object is not parallel to the rear bumper
- The road is slippery or inclined
- The driver backs up the vehicle immediately after shifting to R (Reverse)
- The driver accelerates or circles the vehicle

Reverse Parking Collision-Avoidance Assist may unnecessarily warn the driver or assist with braking even if there are no pedestrians or objects under the following circumstances:

- Any non-factory equipment or accessory is installed
- Your vehicle is unstable due to an accident or other causes
- Bumper height or rear ultrasonic sensor installation has been modified



- Your vehicle height is low or high due to heavy loads, abnormal tire pressure, etc.
- Wide-rear view camera or the rear ultrasonic sensor(s) is stained with foreign matter, such as snow, dirt, etc.
- The pattern on the road is mistaken for a pedestrian
- There is shadow or light reflecting on the ground
- Pedestrians or objects are around the path of the vehicle
- Objects generating excessive noise, such as vehicle horns, loud motorcycle engines or truck air brakes, are near your vehicle
- Your vehicle is backing towards a narrow passage or parking space
- Your vehicle is backing towards an uneven road surface, such as an unpaved road, gravel, bump, gradient, etc.
- A trailer or carrier is installed on the rear of your vehicle
- An ultrasonic sensor with similar frequency is near your vehicle

**⚠ WARNING**

- Always pay extreme caution while driving. The driver is responsible for controlling the brake for safe driving.
- Always pay attention to road and traffic conditions while driving, whether or not there is a warning.
- Always look around your vehicle to make sure there are no pedestrians or objects before moving the vehicle.
- The performance of Reverse Parking Collision-Avoidance Assist may vary under certain conditions.

If vehicle speed is above 2 mph (4 km/h), Reverse Parking Collision-Avoid-

ance Assist will provide collision avoidance assist only when pedestrians are detected. Always look around and pay attention when backing up your vehicle.

- Some objects may not be detected by the rear ultrasonic sensors due to the objects distance, size or material, all of which can limit the effectiveness of the sensor.
- Reverse Parking Collision-Avoidance Assist may not operate properly or may operate unnecessarily depending on the road conditions and the surroundings. Always pay attention to your surroundings while driving.
- Do not solely rely on Reverse Parking Collision-Avoidance Assist. Reverse Parking Collision-Avoidance Assist might not assist the driver leading to pedestrian injury or vehicle damage.
- Always keep the wide-rear view camera and rear ultrasonic sensors clean.
- Do not use any cleanser containing acid or alkaline detergents when cleaning the wide-rear view camera lens.

Use only a mild soap or neutral detergent, and rinse thoroughly with water.

- Do not spray the wide-rear view camera or the rear ultrasonic sensors or their surrounding area directly with a high pressure washer. It may cause the wide-rear view camera or the rear ultrasonic sensors to malfunction.
- Do not apply foreign matters, such as a bumper sticker or a bumper guard, near the wide-rear view camera or rear ultrasonic sensors or apply paint to the bumper.

Doing so may adversely affect the performance of Reverse Parking Collision-Avoidance Assist.

- Never disassemble or apply impact on the wide-rear view camera or the rear ultrasonic sensors components.
  - Do not apply unnecessary force on the wide-rear view camera or the rear ultrasonic sensors. Reverse Parking Collision-Avoidance Assist may not operate properly if the wide-rear view camera or the rear ultrasonic sensor(s) is forcibly moved out of proper alignment. In this case, have your vehicle inspected by an authorized Kia dealer.
  - A braking sound may be heard when the vehicle is stopped to avoid collision.
  - If any other warning sound such as the seat belt warning chime is already generated, Reverse Parking Collision-Avoidance Assist warning may not sound.
  - Reverse Parking Collision-Avoidance Assist may not work properly if the bumper has been damaged, replaced or repaired.
  - Reverse Parking Collision-Avoidance Assist may turn off if interfered by strong electromagnetic waves.
  - Playing the vehicle audio system at high volume may prevent passengers from hearing Reverse Parking Collision-Avoidance Assist warning sounds.
- 

**\* NOTICE**

Reverse Parking Collision-Avoidance Assist can detect a pedestrian or an object when:

- A pedestrian is standing behind the vehicle.
  - A large obstacle, such as a vehicle, is parked in the rear center of your vehicle.
-

## Declaration of conformity (if equipped)

The radio frequency components (Front Radar) complies:

For United States and United States territories



FCC ID  
: 2A302-MRR20

This device complies with Part 15 of the FCC Rules. Operation is subject to the following two conditions:  
(1) this device may not cause harmful interference, and  
(2) this device must accept any interference received, including interference that may cause undesired operation.

**CAUTION TO USERS**  
Changes or modifications not expressly approved by the party responsible for compliance could void the user's authority to operate the equipment.

OSP2052513L

For Canada

Model: MRR-20  
IC: 27992-MRR20

This device complies with Industry Canada licence-exempt RSS standard(s). Operation is subject to the following two conditions:  
(1) this device may not cause interference, and  
(2) this device must accept any interference, including interference that may cause undesired operation of the device.

Le présent appareil est conforme aux CNR d'Industrie Canada applicables aux appareils exempts de licence. L'exploitation est autorisée aux deux conditions suivantes:  
(1) l'appareil ne doit pas produire de brouillage, et  
(2) l'utilisateur de l'appareil doit accepter tout brouillage radioélectrique subi, même si le brouillage est susceptible d'en compromettre le fonctionnement.

OSP2052514L

### The radio frequency components (Rear Corner Radar) complies:

For United States and United States territories



This device complies with Part 15 of the FCC Rules. Operation is subject to the following two conditions:

- (1) this device may not cause harmful interference, and
- (2) this device must accept any interference received, including interference that may cause undesired operation.

**CAUTION TO USERS**

Changes or modifications not expressly approved by the party responsible for compliance could void the user's authority to operate the equipment.

OYB060041L

### For Canada

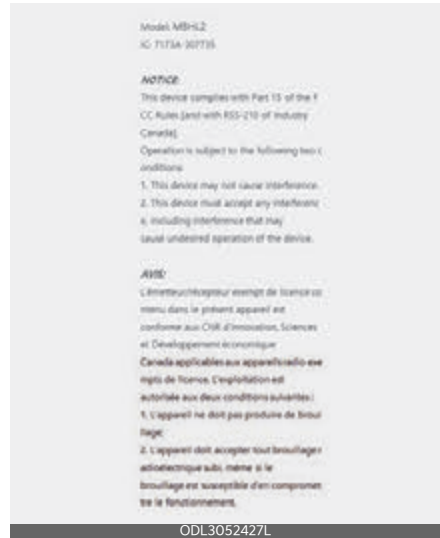

### Radio frequency radiation exposure information:

This equipment complies with FCC radiation exposure limits set forth for an uncontrolled environment. This equipment should be installed and operated with minimum distance of 8 in (20 cm) between the radiator (antenna) and your body. This transmitter must not be co-located or operating in conjunction with any other antenna or transmitter.

6



# What to do in an emergency

<b>Road warning</b> .....	<b>7-2</b>
• Hazard warning flasher.....	7-2
<b>In case of an emergency while driving</b> .....	<b>7-2</b>
• If the vehicle stalls while driving.....	7-2
• If the engine stalls at a crossroad or crossing.....	7-2
• If you have a flat tire while driving.....	7-2
<b>If the engine will not start</b> .....	<b>7-3</b>
• If engine doesn't turn over or turns over slowly.....	7-3
• If engine turns over normally but does not start.....	7-3
<b>Emergency starting</b> .....	<b>7-4</b>
• Jump-starting.....	7-4
• Push-starting.....	7-6
<b>If the engine overheats</b> .....	<b>7-6</b>
<b>Tire Pressure Monitoring System (TPMS)</b> .....	<b>7-8</b>
• Effective use of TPMS.....	7-8
• Low tire pressure telltale.....	7-9
• TPMS malfunction indicator.....	7-10
• Tire replacement with TPMS.....	7-11
• This device complies with Part 15 of the FCC rules.....	7-12
<b>If you have a flat tire (with spare tire)</b> .....	<b>7-12</b>
• Jack and tools.....	7-12
• Changing tires.....	7-14
• Important - use of compact spare tire.....	7-18
• Jack label.....	7-20
<b>Towing</b> .....	<b>7-21</b>
• Towing without wheel dollies when using a towing service.....	7-21

## What to do in an emergency

### Road warning

When an emergency situation occurs while driving or when you park by the edge of the roadway, you must alert approaching or passing vehicles to be careful as they pass. For this, you should use the hazard warning flasher.

### Hazard warning flasher

The hazard warning flasher serves as a warning to other drivers to exercise extreme caution when approaching, overtaking, or passing your vehicle.

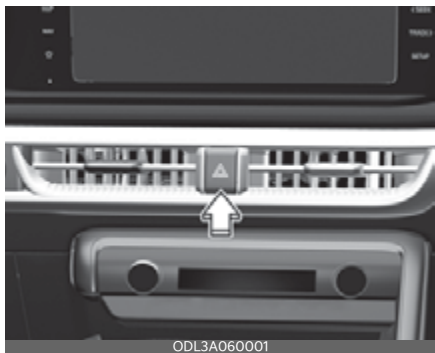

It should be used whenever emergency repairs are being made or when the vehicle is stopped near the edge of a roadway.

Depress the flasher switch with the ENGINE START/STOP button in any position. The flasher switch is located in the center fascia panel. All turn signal lights will flash simultaneously.

- The hazard warning flasher operates whether your vehicle is running or not.
- The turn signals do not work when the hazard flasher is on.
- Care must be taken when using the hazard warning flasher while the vehicle is being towed.

## In case of an emergency while driving

If an emergency situation occurs while driving, stay calm and take the following steps.

### If the vehicle stalls while driving

1. Reduce your speed gradually, keeping a straight line.
2. Move cautiously off the road to a safe place.
3. Turn on your hazard warning flasher.
4. Try to start the vehicle again. If your vehicle will not start, contact an authorized Kia dealer or seek other qualified assistance.

### If the engine stalls at a crossroad or crossing

- If the engine stalls at a crossroad or crossing, set the shift lever in the N (Neutral) position and then push the vehicle to a safe place.

### If you have a flat tire while driving

1. Take your foot off the accelerator pedal and let the vehicle slow down while driving straight ahead.  
Do not apply the brakes immediately or attempt to pull off the road as this may cause a loss of control.
2. When the vehicle has slowed to such a speed that it is safe to do so, brake carefully and pull off the road.
3. Drive off the road as far as possible and park on firm level ground.  
If you are on a divided highway, do not park in the median area between the two traffic lanes.
4. When the vehicle is stopped, turn on your emergency hazard flashers, set

the parking brake and put the transmission in P.

5. Have all passengers get out of the vehicle. Be sure they all get out on the side of the vehicle that is away from traffic.
6. When changing a flat tire, follow the instruction provided later in this section for "If you have a flat tire (with spare tire)" on page 7-12.

### \* NOTICE

If there was a check engine light and loss of power or stall and if safe to do so, wait at least 10 seconds to restart the vehicle after it stalls. This may reset the car so it will no longer run at low power (limp home) condition.

## If the engine will not start

When the engine doesn't start, first check to see how much fuel there is and whether the battery is discharged.

### If engine doesn't turn over or turns over slowly

1. Be sure the shift lever is in N (Neutral) or P (Park) and the emergency brake is set.
2. Check the battery connections to be sure they are clean and tight.
3. Turn on the interior light. If the light dims or goes out when you operate the starter, the battery is discharged.
4. Check the starter connections to be sure they are securely tightened.

### ⚠ WARNING

#### Push/pull start

Do not push or pull the vehicle to start it. This could cause damage to your vehicle. Refer to "Jump-starting" on page 7-4.

### If engine turns over normally but does not start

1. Check the fuel level and add fuel if necessary.
2. With the ENGINE START/STOP button in the OFF position, check all connectors at the ignition coils and spark plugs. Reconnect any that may be disconnected or loose.
3. Check the fuel line in the engine compartment.
4. If the engine still does not start, call an authorized Kia dealer or seek other qualified assistance.



## Emergency starting

When the vehicle will not start because of low battery power, you may need to jump start the vehicle.

### Jump-starting

Connect cables in numerical order and disconnect in reverse order.

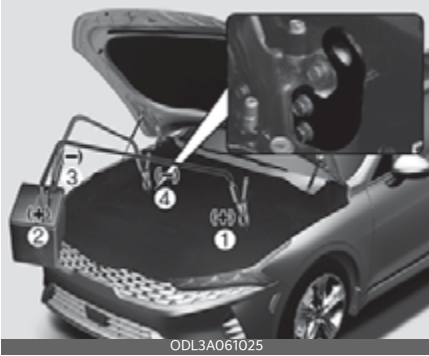

Jump-starting can be dangerous if done incorrectly. Therefore, to avoid harm to yourself or damage to your vehicle or battery, follow these jump-starting procedures. If in doubt, we strongly recommend that you have a competent technician or towing service jump-start your vehicle.

### **⚠ CAUTION**

#### Push/pull start to 12 Volt Battery

Use only a 12-volt jumper system. You can damage a 12-volt starting motor, ignition system, and other electrical parts beyond repair by use of a 24-volt power supply (either two 12-volt batteries in series or a 24-volt motor generator set).

### **⚠ WARNING**

#### Battery

- Never attempt to check the electrolyte level of the battery, as this may cause the battery to rupture or explode.
- Keep all flames or sparks away from the battery. The battery produces hydrogen gas which may explode if exposed to flame or sparks.

If these instructions are not followed exactly, serious personal injury and damage to the vehicle may occur! If you are not sure how to follow this procedure, seek qualified assistance. Automobile batteries contain sulfuric acid. This is poisonous and highly corrosive. When jump starting, wear protective glasses and be careful not to get acid on yourself, your clothing or on the vehicle.

- Do not attempt to jump start the vehicle if the discharged battery is frozen or if the electrolyte level is low; the battery may rupture or explode.
- Do not allow the (+) and (-) jumper cables to touch. It may cause sparks.
- The battery may rupture or explode when you jump start with a low or frozen battery.

### **⚠ WARNING**

#### Frozen batteries

Do not attempt to jump start the vehicle if the discharged battery is frozen, as the battery may rupture or explode.

**⚠ WARNING****Battery**

Keep all flames or sparks away from the battery. The battery produces hydrogen gas, which will explode if exposed to flame or sparks.

**⚠ WARNING****Battery cables**

Do not connect the jumper cable from the negative terminal of the booster battery to the negative terminal of the discharged battery, directly. This can cause the discharged battery to overheat and crack or degrade. Make sure to connect one end of the jumper cable to the negative terminal of the booster battery, and the other end to a metallic point, far away from the battery.

**⚠ WARNING****Sulfuric acid risk**

Automobile batteries contain sulfuric acid. When jump starting your vehicle, be careful not to get sulfuric acid on yourself, your clothing, or on the vehicle. This acid is poisonous and highly corrosive.

**Jump-starting**

1. Make sure the booster battery is 12-volt and that its negative terminal is grounded.  
If the booster battery is in another vehicle, do not allow the vehicles to come in contact.
2. Turn off all unnecessary electrical loads.
3. Connect the jumper cables in the exact sequence shown in the illustration.

- 1) Connect one end of a jumper cable to the positive terminal of the discharged battery (1).
- 2) Connect the other end to the positive terminal of the booster battery (2).
- 3) Proceed to connect one end of the other jumper cable to the negative terminal of the booster battery (3), then the other end to a solid, stationary, metallic point away from the battery (4).  
Do not allow the jumper cables to contact anything except the correct battery terminals or the correct ground. Do not lean over the battery when making connections.
4. Start vehicle with the booster battery and let it run at 2,000 rpm, then start the vehicle with the discharged battery.

**If the cause of your battery discharging is not apparent, you should have your vehicle checked by an authorized Kia dealer.**

**\* NOTICE****Battery cables**

Do not connect the jumper cable from the negative terminal of the booster battery to the negative terminal of the discharged battery. This can cause the discharged battery to overheat and crack, releasing battery acid.

Make sure to connect one end of the jumper cable to the negative terminal of the booster battery, and the other end to a metallic point, far away from the battery.

## Push-starting

Vehicles equipped with automatic transmission cannot be push-started, and only jump starting can be applied. Follow the directions in this section for "Jump-starting" on page 7-4.

### **WARNING**

#### **Tow starting vehicle**

Never tow a vehicle to start it.

When the engine starts, the vehicle can suddenly surge forward and could cause a collision with the tow vehicle.

---

## If the engine overheats

If your temperature gauge indicates overheating, you experience a loss of power, or hear a loud pinging or knocking, the engine is probably too hot.

If this happens, you should:

1. Pull off the road and stop as soon as it is safe to do so.
2. Place the shift lever in P and set the parking brake.
3. If the air conditioning is on, turn it off.
4. If engine coolant is running out under the vehicle or steam is coming out from underneath the hood, stop the engine. Do not open the hood until the coolant has stopped running or the steaming has stopped.
5. If there is no visible loss of engine coolant and no steam, leave the engine running and check to be sure the engine cooling fan is operating.
  - 1) If the fan is not running, turn the engine off.
6. Check to see if the water pump drive belt is missing.
  - 1) If it is not missing, check to see that it is tight.
  - 2) If the drive belt seems to be satisfactory, check for coolant leaking from the radiator, hoses or under the vehicle. (If the air conditioning had been in use, it is normal for cold water to be draining from it when you stop).

**⚠ WARNING****Under the hood**

While the engine is running, keep hair, hands and clothing away from moving parts, such as the fan and drive belts, to prevent injury.

7. If the water pump drive belt is broken or engine coolant is leaking out, stop the engine immediately and call the nearest authorized Kia dealer for assistance.
8. If you cannot find the cause of the overheating, wait until the engine temperature has returned to normal. If coolant has been lost, carefully add coolant to the reservoir to bring the fluid level in the reservoir up to the halfway mark.
9. Proceed with caution, keeping alert for further signs of overheating. If overheating happens again, call an authorized Kia dealer for assistance.

**⚠ WARNING****Engine coolant reservoir cap**

Do not remove the engine coolant reservoir cap when the engine is hot. This may result in coolant being blown out of the opening and cause serious burns.

**⚠ CAUTION**

- Serious loss of coolant indicates there is a leak in the cooling system and this should be checked as soon as possible by an authorized Kia dealer.
- When the engine overheats from low engine coolant, suddenly adding engine coolant may cause cracks in the engine. To prevent damage, add engine coolant slowly in small quantities.

## Tire Pressure Monitoring System (TPMS)

The Tire Pressure Monitoring System (TPMS) detects the pressure of vehicle's tires and displays it on the LCD display.



ODL3A061005

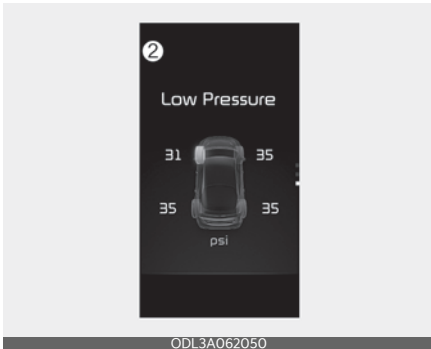

ODL3A062050

1. Low tire pressure telltale / TPMS malfunction indicator
2. Low tire pressure position telltale (Shown on the LCD display)

### Tire Pressure Indicator

- You can check the tire pressure in the information mode on the cluster.
  - Refer to "LCD display modes" on page 4-69.
- Tire pressure is displayed 1~2 minutes later after driving.

- If tire pressure is not displayed when the vehicle is stopped, "Drive to display" message displays. After driving, check the tire pressure.
- You can change the tire pressure unit in the user settings mode on the cluster.
  - psi, kPa, bar (Refer to "User Settings mode" on page 4-72).

### \* NOTICE

- The tire pressure may change due to factors such as parking condition, driving style, and altitude above sea level.
- The tire pressure shown on the dashboard may differ from the tire pressure measured by tire pressure gauge.
- Low tire pressure warning may sound when a tire's pressure unit is equal or lower than nearby tires. This is a normal occurrence, which is due to the change in tire pressure along with tire temperature.

### Effective use of TPMS

#### ⚠ WARNING

Over-inflation or under-inflation can reduce tire life, adversely affect vehicle handling, and lead to sudden tire failure that may cause loss of vehicle control resulting in an accident

Each tire, including the spare (if provided), should be checked monthly when cold and inflated to the inflation pressure recommended by the vehicle manufacturer on the vehicle placard or tire inflation pressure label.

(If your vehicle has tires of a different size than the size indicated on the vehi-

cle placard or tire inflation pressure label, you should determine the proper tire inflation pressure for those tires.)

As an added safety feature, your vehicle has been equipped with a tire pressure monitoring system (TPMS) that illuminates a low tire pressure telltale when one or more of your tires is significantly under-inflated. Accordingly, when the low tire pressure telltale illuminates, you should stop and check your tires as soon as possible, and inflate them to the proper pressure. Driving on a significantly under-inflated tire causes the tire to overheat and can lead to tire failure. Under-inflation also reduces fuel efficiency and tire tread life, and may affect the vehicle's handling and stopping ability.

Please note that the TPMS is not a substitute for proper tire maintenance, and it is the driver's responsibility to maintain correct tire pressure, even if under-inflation has not reached the level to trigger illumination of the TPMS low tire pressure telltale.

Your vehicle has also been equipped with a TPMS malfunction indicator to indicate when the system is not operating properly. The TPMS malfunction indicator is combined with the low tire pressure telltale. When the system detects a malfunction, the telltale will flash for approximately one minute and then remain continuously illuminated. This sequence will continue upon subsequent vehicle start-ups as long as the malfunction exists. When the malfunction indicator is illuminated, the system may not be able to detect or signal low tire pressure as intended. TPMS malfunctions may occur for a variety of reasons, including the installation of replacement or alternate tires or wheels

on the vehicle that prevent the TPMS from functioning properly.

Always check the TPMS malfunction telltale after replacing one or more tires or wheels on your vehicle to ensure that the replacement or alternate tires and wheels allow the TPMS to continue to function properly.

**\* NOTICE**

If any of the below happens, have the system checked by an authorized Kia dealer.

1. The low tire pressure telltale/TPMS malfunction indicator does not illuminate for 3 seconds when the ENGINE START/STOP button is turned to the ON position or engine is running.
2. The TPMS malfunction indicator remains illuminated after blinking for approximately 1 minute.
3. The Low tire pressure position telltale remains illuminated.

**Low tire pressure telltale (!)**

**Low tire pressure position telltale**

When the TPMS warning indicators are illuminated, one or more of your tires is significantly under-inflated.

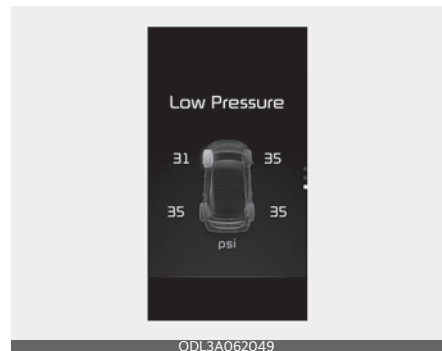

If the telltale illuminates, immediately reduce your speed, avoid hard cornering and anticipate increased stopping distances. You should stop and check your tires as soon as possible.

Inflate the tires to the proper pressure as indicated on the vehicle's placard or tire inflation pressure label located on the driver's side center pillar outer panel. If you cannot reach a service station or if the tire cannot hold the newly added air, replace the low pressure tire with the spare tire.

Then the TPMS malfunction indicator and the Low Tire Pressure telltale may turn on and illuminate after restarting and about 20 minutes of continuous driving before you have the low pressure tire repaired and replaced on the vehicle.

In winter or cold weather, the low tire pressure telltale may be illuminated if the tire pressure was adjusted to the recommended tire inflation pressure in warm weather. It does not mean your TPMS is malfunctioning because the decreased temperature leads to a proportional lowering of tire pressure.

You should check the tire inflation pressure and adjust the tires to the recommended tire inflation pressure when driving your vehicle in the following conditions.

- from a warm area to a cold area
- from a cold area to a warm area
- the outside temperature is extremely high or low

When filling tires with more air, conditions to turn off the low tire pressure telltale may not be met. This is because a tire inflator has a margin of error in performance. The low tire pressure telltale will be turned off if the tire pressure is

above the recommended tire inflation pressure.

**⚠ WARNING**

**Low pressure damage**

Do not drive on low pressure tires. Significantly low tire pressure can cause the tires to overheat and fail, making the vehicle unstable, resulting in increased braking distances and a loss of vehicle control.

**TPMS malfunction indicator (!)**

The low tire pressure telltale will illuminate after it blinks for approximately one minute when there is a problem with the TPMS.

If the system is able to correctly detect an underinflation warning at the same time as system failure, it will illuminate both the TPMS malfunction and the low tire pressure position telltales. For example, if the Front Left sensor fails, the TPMS malfunction indicator illuminates, but if the Front Right, Rear Left, or Rear Right tire is underinflated, the low tire pressure position telltales may illuminate together with the TPMS malfunction indicator.

Have the system checked by an authorized Kia dealer as soon as possible to determine the cause of the problem.

- The TPMS malfunction indicator may be illuminated if the vehicle is moving around electric power supply cables or radios transmitters such as at police stations, government and public offices, broadcasting stations, military installations, airports, or transmitting towers, etc. This can interfere with normal operation of the TPMS.

- The TPMS malfunction indicator may illuminate if the vehicle is equipped with snow chains or some personal electronic devices (such as a laptop computer, mobile charger, remote starter or navigation) are being used in the vehicle. This can interfere with normal operation of the TPMS.

### Tire replacement with TPMS

If you have a flat tire, the Low Tire Pressure telltale will come on. Have the flat tire repaired by an authorized Kia dealer as soon as possible or replace the flat tire with the spare tire.

#### CAUTION

#### Repair Agents

Never use a puncture-repairing agent not approved by Kia to repair and/or inflate a low pressure tire. Sealant that is not approved by Kia may damage the tire pressure sensor.

Each wheel is equipped with a tire pressure sensor mounted inside the tire behind the valve stem. You must use TPMS specific wheels. Have always your tires serviced by an authorized Kia dealer.

Even if you replace the low pressure tire with the spare tire, the Low Tire Pressure telltale will remain on until the low pressure tire is repaired and placed on the vehicle.

After you replace the low pressure tire with the spare tire, the TPMS malfunction indicator may illuminate after a few minutes. This is because the TPMS sensor mounted on the spare wheel is not yet activated.

Once the low pressure tire is inflated again to the recommended pressure and installed on the vehicle or the TPM sen-

sor mounted on the replaced spare wheel is initiated by an authorized Kia dealer, the TPMS malfunction indicator and the low tire pressure telltale will turn off within a few minutes of driving.

If the indicator has not disappeared after a few minutes of driving, please visit an authorized Kia dealer.

If an original mounted tire is replaced with the spare tire, the TPMS sensor on the replaced spare wheel should be initiated and the TPMS sensor on the original mounted wheel should be deactivated. If the TPMS sensor on the original mounted wheel located in the spare tire carrier still activates, the Tire Pressure Monitoring System may not operate properly. Have the tire with TPMS serviced or replaced by an authorized Kia dealer.

You may not be able to identify a low tire by simply looking at it. Always use a good quality tire pressure gauge to measure the tire's inflation pressure. Please note that a tire that is hot (from being driven) will have a higher pressure measurement than a tire that is cold (from sitting stationary for at least 3 hours and driven less than 1 mile (1.6 km) during that 3 hour period).

Allow the tire to cool before measuring the inflation pressure. Always be sure the tire is cold before inflating to the recommended pressure.

A cold tire means the vehicle has been sitting for 3 hours and driven for less than 1 mile (1.6 km) in that 3 hour period. Never use tire sealant if your vehicle is equipped with a TPMS. The liquid sealant can damage the tire pressure sensors.

- The TPMS cannot alert you to severe and sudden tire damage caused by



external factors such as nails or road debris.

- If you feel any vehicle instability, immediately take your foot off the accelerator, apply the brakes gradually and with light force, and slowly move to a safe position off the road.

**\* NOTICE**

**Protecting TPMS**

Tampering with, modifying, or disabling the Tire Pressure Monitoring System (TPMS) components may interfere with the system's ability to warn the driver of low tire pressure conditions and/or TPMS malfunctions. Tampering with, modifying, or disabling the Tire Pressure Monitoring System (TPMS) components may void the warranty for that portion of the vehicle.

**This device complies with Part 15 of the FCC rules.**

Operation is subject to the following three conditions:

1. This device may not cause harmful interference, and
2. This device must accept any interference received, including interference that may cause undesired operation.
3. Changes or modifications not expressly approved by the party responsible for compliance could void the user's authority to operate the device.

**If you have a flat tire (with spare tire)**

If you have a flat tire, you can change the flat tire to a spare tire using tools.

**⚠ WARNING**

Driving on a flat tire will cause permanent damage to the tire. Re-inflating a tire after it has been driven on while severely underinflated or flat may cause a blowout and a serious crash. Never attempt to re-inflate a tire that has been driven on while severely underinflated or flat. In this case, repair or replace the flat tire as soon as possible.

**⚠ WARNING**

Changing a tire can be dangerous. Follow the instructions in this section when changing a tire to reduce the risk of serious injury or death.

**⚠ CAUTION**

Be careful as you use the jack handle to stay clear of the flat end. The flat end has sharp edges that could cause cuts.

**Jack and tools**



1. Jack handle

2. Jack
3. Wheel lug nut wrench

The jack and tools are stored in the luggage side trim.

Remove the tray cover indicated in the illustration.

### Jacking instructions

The jack is provided for emergency tire changing only.

- To prevent the jack from "rattling" while the vehicle is in motion, store it properly.
- Follow jacking instructions to reduce the possibility of personal injury.

### **⚠ WARNING**

#### Changing tires

- Never attempt vehicle repairs in the traffic lanes of a public road or highway.
- Always move the vehicle completely off the road and onto the shoulder before trying to change a tire. The jack should be used on firm level ground. If you cannot find a firm level place off the road, call a towing service company for assistance.
- Be sure to use the correct front and rear jacking positions on the vehicle; never use the bumpers or any other part of the vehicle for jacking support.
- The vehicle can roll off the jack causing serious injury or death.
- Do not go under a vehicle that is supported by a jack.
- Do not start or run the engine while the vehicle is on the jack.
- Do not allow anyone to remain in the vehicle while it is on the jack.
- Make sure any children present are in a secure place, away from the road

and from the vehicle to be raised with the jack.

### **⚠ WARNING**

#### Tire jack

Do not place any portion of your body under a vehicle that is only supported by a jack since the vehicle can easily roll off the jack. Use vehicle support stands.

### **⚠ WARNING**

#### Changing tires

Never attempt vehicle repairs in the traffic lanes of a public road or highway.

### **⚠ WARNING**

#### Running vehicle on jack

Do not start or run the engine of the vehicle while the vehicle is on the jack as this may cause the vehicle to fall off the jack.

To prevent the jack from "rattling" while the vehicle is in motion, store it properly.

### **\* NOTICE**

#### Retreaded tires

Substantial design variations and the age of the retreaded tire casing structure can limit service life and have negative impact on road safety.

## Removing and storing the spare tire



- Turn the tire hold-down wing bolt counterclockwise to remove.
- Store the tire in the reverse order of removal.
- To prevent the spare tire and tools from "rattling" while the vehicle is in motion, store them properly.

### **⚠ WARNING**

#### **Touching surface of the luggage room floor**

Do not touch the metal surface of the luggage room floor while the engine is operating or hot. Doing so could result in serious bodily injury.

Turn the engine off and wait until it cools down or wear gloves to remove the spare tire from the luggage room.

If it is hard to loosen the tire hold down wing bolt by hand, you can loosen it easily using the jack handle.



- Put the jack handle (1) inside of the tire hold-down wing bolt.
- Turn the tire hold-down wing bolt counterclockwise with the jack handle. Use caution when utilizing the sharp jack handle.

## Changing tires

### **⚠ WARNING**

A vehicle can slip or roll off of a jack causing serious injury or death to you or those nearby. Take the following safety precautions:

- Never place any portion of your body under a vehicle that is supported by a jack.
- NEVER attempt to change a tire in the lane of traffic. ALWAYS move the vehicle completely off the road on level, firm ground away from traffic before trying to change a tire. If you cannot find a level, firm place off the road, call a towing service for assistance.
- Be sure to use the jack provided with the vehicle.
- ALWAYS place the jack on the designated jacking positions on the vehicle and NEVER on the bumpers or any

other part of the vehicle for jacking support.

- Do not start or run the engine while the vehicle is on the jack.
- Do not allow anyone to remain in the vehicle while it is on the jack.
- Keep children away from the road and the vehicle.

1. Park on a level surface and apply the parking brake firmly.
2. Place the transmission shift lever in P (Park).
3. Activate the hazard warning flashers.



4. Remove the wheel lug nut wrench, jack and spare tire from the vehicle.



5. Block both the front and rear of the wheel that is diagonally opposite from the jack position.

**⚠ WARNING**

**Jack location**

To reduce the possibility of injury, be sure to only use the jack provided with the vehicle in the correct jack position; never use any other part of the vehicle for jack support.

**⚠ WARNING**

**Changing a tire**

- To prevent vehicle movement while changing a tire, always set the parking brake fully, and always block the wheel diagonally, opposite the wheel being changed.
- We recommend that the wheels of the vehicle be blocked, and that no person remain in a vehicle that is being jacked.

6. Loosen the wheel lug nuts counter-clockwise one turn each, but do not remove any nut until the tire has been raised off the ground.



7. Place the jack at the front (1) or rear (2) jacking position closest to the tire you are changing. Place the jack at the designated locations under the frame. The jacking positions are plates welded to the frame with two

7

tabs and a raised dot to line up with the jack.

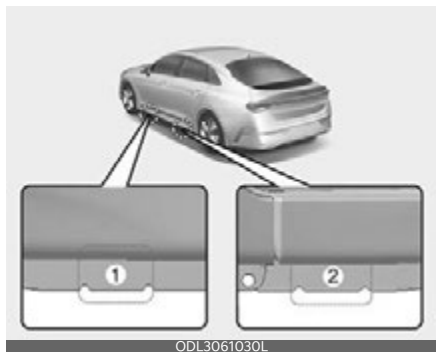
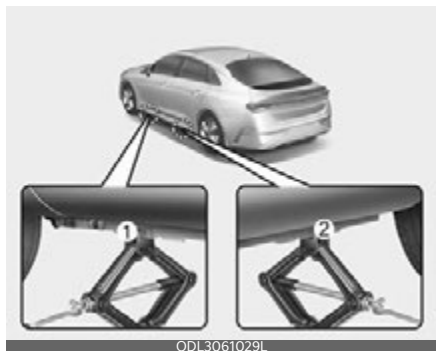

8. Insert the wheel lug nut wrench into the jack and turn it clockwise, raising the vehicle until the tire just clears the ground. This measurement is approximately 1 inch (25 mm).



Before removing the wheel lug nuts, make sure the vehicle is stable and that there is no chance for movement or slippage.

9. Loosen the wheel nuts and remove them with your fingers.
10. Slide the wheel off the studs and lay it flat so it cannot roll away.
11. To put the wheel on the hub, pick up the spare tire, line up the holes with the studs and slide the wheel onto them. If this is difficult, tip the wheel slightly and get the top hole in the wheel lined up with the top stud.
12. Move the wheel back and forth until the wheel can slide over the other studs.

Wheels may have sharp edges. Handle them carefully to avoid possible severe injury. Before putting the wheel into place, be sure that there is nothing on the hub or wheel (such as mud, tar, gravel, etc.) that prevents the wheel from fitting solidly against the hub.

**⚠ WARNING**

**Installing a wheel**

- When you install a wheel, always remove any corrosion, dirt or foreign materials present on the mounting surfaces of the wheel or the surface of the wheel hub, brake drum or brake disc that contacts the wheel. Make sure to secure any fasteners that attach the rotor to the hub so they do not interfere with the mounting surfaces of the wheel. Installing wheels without correct metal-to-metal contact at the wheel mounting surfaces can cause the wheel nuts to loosen and the wheel to come off while your vehicle is in motion, resulting in loss of

vehicle control, personal injury or death.

- Make sure the wheel makes good contact with the hub when installed. If the contact of the mounting surface between the wheel and hub is not good, the wheel nuts could come loose and cause the loss of a wheel. Loss of a wheel may result in loss of control of the vehicle.

**⚠ WARNING**

Wheel covers will not fit on the vehicle's compact spare. If you try to put a wheel cover on the compact spare, the cover or the spare could be damaged.

13. To install the wheel, hold it on the studs, put the wheel nuts on the studs and tighten them finger tight.
14. Move the tire to be sure it is completely seated, then tighten the nuts as much as possible with your fingers again.
15. Insert the wrench into the jack and lower the vehicle to the ground by turning the wheel nut wrench counterclockwise.
16. Position the wrench as shown in the drawing and tighten the wheel nuts. Be sure the socket is seated completely over the nut. Do not stand on the wrench handle or use an extension pipe over the wrench handle.
17. Go around the wheel, tightening every nut following the numerical sequence shown in the image until they are all tight. Double-check the tightness of each nut.



18. After changing wheels, have an authorized Kia dealer tighten the wheel nuts to their proper torque as soon as possible.

19. To prevent the jack, wheel lug nut wrench and spare tire from rattling while the vehicle is in motion, store them properly.

20. Check the inflation pressures as soon as possible after installing the spare tire. Adjust it to the specified pressure, if necessary. Refer to "Tires and wheels" on page 8-33.

**Wheel nut tightening torque:**

79~94 lbf·ft (11~13 kgf·m)

If you have a tire gauge, remove the valve cap and check the air pressure. If the pressure is lower than recommended, drive slowly to the nearest service station and inflate to the recommended pressure. If it is too high, adjust it until it becomes appropriate. Always reinstall the valve cap after checking or adjusting the tire pressure. If the cap is not replaced, dust and dirt may get into the tire valve and air may leak from the tire. If you lose a valve cap, buy another and install it as soon as possible.

After you have changed the wheels, always secure the flat tire in its place

and return the jack and tools to their proper storage locations.

**⚠ CAUTION**

**Reusing lug nuts**

Make certain during wheel removal that the same nuts that were removed are reinstalled - or, if replaced, that nuts with metric threads and the same chamfer configuration are used. Your vehicle has metric threads on the wheel studs and nuts. Installation of a non-metric thread nut on a metric stud will not secure the wheel to the hub properly and will damage the stud so that it must be replaced.

Note that most lug nuts do not have metric threads. Be sure to use extreme care in checking for thread style before installing aftermarket lug nuts or wheels. If in doubt, consult an authorized Kia dealer.

**⚠ WARNING**

**Wheel studs**

If the studs are damaged, they may lose their ability to retain the wheel. This could lead to the loss of the wheel and a collision resulting in serious injuries.

**⚠ WARNING**

Never use oil or grease on bolts or nuts because the nuts might come loose. The vehicle's wheel could fall off, causing a crash.

**Important - use of compact spare tire (if equipped)**

Your vehicle is equipped with a compact spare tire. This compact spare tire takes up less space than a regular-size tire. This tire is smaller than a conventional

tire and is designed for temporary use only.

- You should drive carefully when the compact spare is in use. The compact spare should be replaced by the proper conventional tire and rim at the first opportunity.
- The operation of this vehicle is not recommended with more than one compact spare tire in use at the same time.

**⚠ WARNING**

**Spare tire**

The compact spare tire is for emergency use only. Do not operate your vehicle on this compact spare at speeds over 50 mph (80 km/h). The original tire should be repaired or replaced as soon as possible to avoid failure of the spare, possibly leading to bodily injury or death.

The compact spare should be inflated to 60 psi (420 kPa).

**\* NOTICE**

Check the inflation pressure after installing the spare tire. Adjust it to the specified pressure, as necessary.

When using a compact spare tire, observe the following precautions:

- Under no circumstances should you exceed 50 mph (80 km/h); a higher speed could damage the tire.
- Ensure that you drive slowly enough for the road conditions to avoid all hazards. Any road hazard, such as a pothole or debris, could seriously damage the compact spare.
- Any continuous road use of this tire could result in tire failure, loss of vehicle control, and possible personal injury.

- Do not exceed the vehicle's maximum load rating or the load-carrying capacity shown on the sidewall of the compact spare tire.
- Avoid driving over obstacles. The compact spare tire diameter is smaller than the diameter of a conventional tire and reduces the ground clearance approximately 1 inch (25 mm), which could result in damage to the vehicle.
- Do not take this vehicle through an automatic vehicle wash while the compact spare tire is installed.
- Do not use tire chains on the compact spare tire. Because of the smaller size, a tire chain will not fit properly. This could damage the vehicle and result in loss of the chain.
- Do not use the compact spare tire on any other vehicle because this tire has been designed especially for your vehicle.
- The compact spare tire's tread life is shorter than a regular tire. Inspect your compact spare tire regularly and replace worn compact spare tires with the same size and design, mounted on the same wheel.
- The compact spare tire should not be used on any other wheels, nor should standard tires, snow tires, wheel covers or trim rings be used with the compact spare wheel. If such use is attempted, damage to these items or other vehicle components may occur.
- Do not use more than one compact spare tire at a time.
- Do not tow a trailer while the compact spare tire is installed.
- Do not suddenly accelerate or decelerate (0 ↔ 25 mph (0 ↔ 40 km/h)) in any driving mode. It may cause leakage of transfer oil.



Jack label

Type A

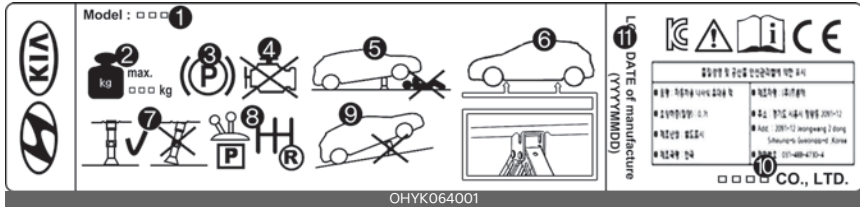

Type B

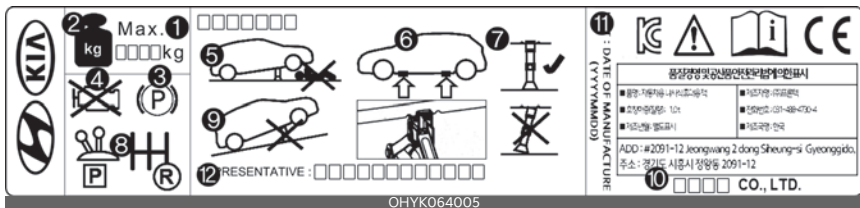

Type C



\* The actual jack label in the vehicle may differ from the illustration. For more detailed specifications, refer to the label attached to the jack.

1. Model Name
2. Maximum allowable load
3. When using the jack, set your parking brake.
4. When using the jack, stop the engine.
5. Do not get under a vehicle that is supported by a jack.
6. The designated locations under the frame
7. When supporting the vehicle, the base plate of jack must be vertical under the lifting point.
8. Move the shift lever to the P position on vehicles with automatic transmission.
9. The jack should be used on firm level ground.
10. Jack manufacturer
11. Production date
12. Representative company and address

## Towing

If emergency towing is necessary, have it done by authorized Kia dealer or a commercial tow-truck service.

### Towing service

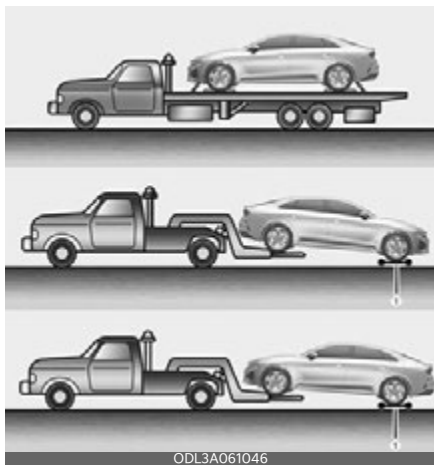

#### 1. dollies

Proper lifting and towing procedures are necessary to prevent damage to the vehicle. The use of wheel dollies (1) or flatbed is recommended.

It is acceptable to tow the vehicle with the rear wheel on the ground (without dollies) and the front wheels off the ground. If any of the loaded wheels or suspension components are damaged or the vehicle is being towed with the front wheels on the ground, use a towing dolly under the front wheels. When being towed by a commercial tow truck and wheel dollies are not used, the front of the vehicle should always be lifted, not the rear.

### ⚠ WARNING

#### Side and curtain Air bag

If your vehicle is equipped with side and curtain air bag, set the ENGINE START/STOP button to ACC position when the vehicle is being towed.

The side and curtain air bag may deploy when the ENGINE START/STOP button to ON position and the rollover sensor detects the situation as a rollover.

### \* NOTICE

If the EPB does not release normally, take your vehicle to an authorized Kia dealer by loading the vehicle on a flatbed tow truck and have the system checked.

#### Towing without wheel dollies when using a towing service

When towing your vehicle in an emergency without wheel dollies:

1. Set the ENGINE START/STOP button to ACC position.
2. Place the transmission shift lever in N (Neutral).
3. Release the parking brake.

### ⚠ CAUTION

#### Towing gear position

Failure to shift to N (Neutral) may cause internal damage to the vehicle.

**⚠ CAUTION**

**Towing**



ODL3A061041



ODL3A061042



ODL3A061039

- Do not tow the vehicle backwards with the front wheels on the ground, as this may cause damage to the transmission.
- Do not tow with sling-type equipment. Use wheel lift or flatbed equipment.
- Do not tow the vehicle with four wheels in contact with the ground if it is the vehicle equipped with DCT or AT. Otherwise, the transmission will be seriously damaged. Also, make sure not to tow the vehicle connecting it with other vehicles including camper vans.

**⚠ WARNING**

- If you tow the vehicle while the front wheels are touching the ground, the vehicle motor may generate electricity and the motor components may be damaged or a fire may occur.
- When a fire occurs due to the battery, there is a risk of a secondary fire. Should at anytime a fire occur, immediately contact fire department.

<b>Engine compartment</b> .....	<b>8-4</b>
<b>Maintenance services</b> .....	<b>8-6</b>
<b>Owner maintenance</b> .....	<b>8-7</b>
<b>Scheduled maintenance service</b> .....	<b>8-9</b>
<b>Explanation of scheduled maintenance items</b> .....	<b>8-15</b>
<b>Engine oil and filter</b> .....	<b>8-18</b>
• Checking the engine oil level.....	8-18
• Changing the engine oil and filter.....	8-19
<b>Engine coolant</b> .....	<b>8-21</b>
• Checking the coolant level.....	8-22
• Changing the coolant.....	8-23
<b>Brake fluid</b> .....	<b>8-24</b>
• Checking the brake fluid level.....	8-24
<b>Washer fluid</b> .....	<b>8-25</b>
• Checking the washer fluid level.....	8-25
<b>Air cleaner filter</b> .....	<b>8-26</b>
• Replacing air cleaner filter.....	8-26
<b>Climate control air filter</b> .....	<b>8-28</b>
• Inspecting and replacing climate control air filter.....	8-28
<b>Wiper blades</b> .....	<b>8-29</b>
• Front windshield wiper blade.....	8-30
• Blade replacement.....	8-30
<b>Battery</b> .....	<b>8-31</b>
<b>Tires and wheels</b> .....	<b>8-33</b>
• Checking tire inflation pressure.....	8-35
• Tire rotation.....	8-35
• Wheel alignment and tire balance.....	8-36
• Tire replacement.....	8-37
• Compact spare tire replacement.....	8-37

# 8 Maintenance

• Wheel replacement .....	8-38
• Tire traction .....	8-38
• Tire maintenance .....	8-38
• Tire sidewall labeling.....	8-38
• Tire terminology and definitions.....	8-42
• All season tires .....	8-44
• Summer tires.....	8-45
• Snow tires.....	8-45
• Tire chains.....	8-45
• Radial-ply tires .....	8-46
• Low aspect ratio tire .....	8-46
<b>Fuses.....</b>	<b>8-47</b>
• Replacing inner panel fuse.....	8-49
• Replacing engine compartment fuse.....	8-50
• Fuse/relay panel description .....	8-51
<b>Light bulbs .....</b>	<b>8-59</b>
• Replacing headlamp, position lamp/daytime running lamp bulb, turn signal lamp bulb (LED type) .....	8-62
• Replacing front fog lamp bulb (LED type).....	8-62
• Replacing front side marker lamp bulb (LED type) .....	8-63
• Replacing side repeater lamp bulb (LED type).....	8-63
• Replacing rear tail & stop lamp, stop lamp, turn signal lamp, back up lamp bulb (Bulb type).....	8-63
• Replacing tail lamp, tail & stop lamp, rear side marker bulb (LED type) .....	8-64
• Replacing high mounted stop lamp bulb (LED type).....	8-64
• Replacing license plate lamp bulb (Bulb type) .....	8-65
• Replacing map lamp bulb (Bulb/LED type).....	8-65
• Replacing vanity mirror lamp bulb (Bulb type) .....	8-66
• Replacing room lamp bulb (Bulb type) .....	8-67
• Replacing room lamp bulb (LED type) .....	8-67
• Replacing personal lamp bulb (LED type) .....	8-67

• Replacing trunk room lamp (Bulb type) .....	8-68
<b>Appearance care.....</b>	<b>8-68</b>
• Exterior care .....	8-68
• Interior care .....	8-73
<b>Emission control system .....</b>	<b>8-75</b>
<b>California perchlorate notice .....</b>	<b>8-78</b>

## Maintenance

### Engine compartment

Smartstream G1.6 T-GDi

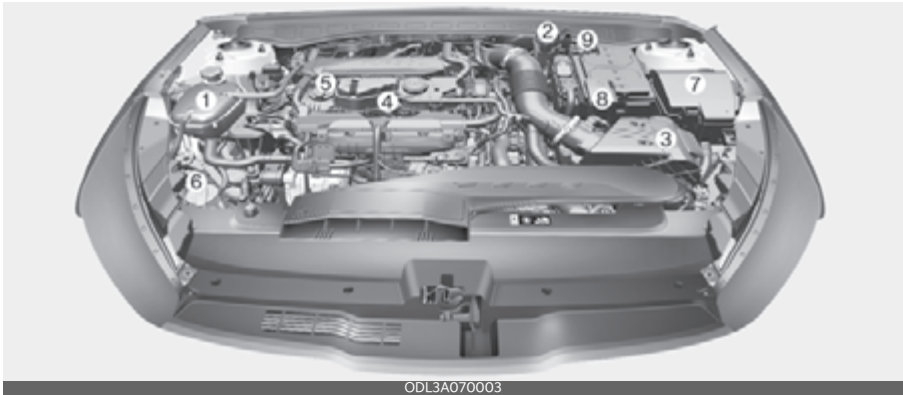

ODL3A070003

Smartstream G2.5 T-GDi

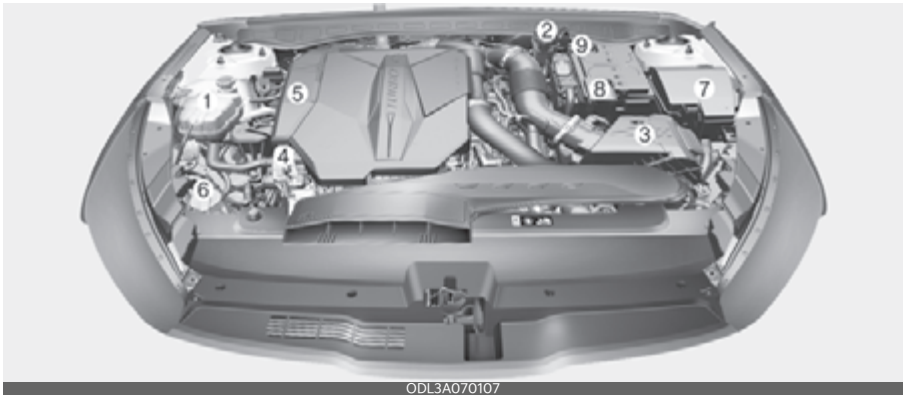

ODL3A070107

\* The actual engine room in the vehicle may differ from the illustration.

1. Engine coolant reservoir
2. Brake fluid reservoir
3. Air cleaner
4. Engine oil dipstick
5. Engine oil filler cap
6. Windshield washer fluid reservoir
7. Fuse box
8. Positive battery terminal

9. Negative battery terminal



## Maintenance services

You should exercise the utmost care to prevent damage to your vehicle and injury to yourself whenever performing any maintenance or inspection procedures.

Should you have any doubts concerning the inspection or servicing of your vehicle, have an authorized Kia dealer perform this work.

An authorized Kia dealer has factory-trained technicians and genuine Kia parts to service your vehicle properly. For expert advice and quality service, see an authorized Kia dealer.

Inadequate, incomplete or insufficient servicing may result in operational problems with your vehicle that could lead to vehicle damage, an accident, or personal injury.

## Owner's responsibility

### \* NOTICE

Maintenance Service and Record Retention are the owner's responsibility.

You should retain documents that show proper maintenance has been performed on your vehicle in accordance with the scheduled maintenance service charts shown on the following pages. You need this information to establish your compliance with the servicing and maintenance requirements of your vehicle warranties.

Detailed warranty information is provided in your Warranty & Consumer Information manual.

---

Repairs and adjustments required as a result of improper maintenance or a lack of required maintenance are not covered.

Have your vehicle maintained and repaired by an authorized Kia dealer. Authorized Kia dealers meet Kia's high service quality standards and receive technical support from Kia in order to provide you with a high level of service satisfaction.

### \* NOTICE

#### NHTSA Safety Corrosion Alert

The National Highway Traffic Safety Administration (NHTSA) has issued a general warning to all vehicle owners of all brands regarding the risks associated with vehicle underbody corrosion. From your initial purchase, take the following steps to prevent unsafe corrosion damage to your vehicle:

- Wash the undercarriage of your vehicle regularly during the winter and whenever your vehicle has been exposed to such salts or chemicals.
  - Do a thorough washing of the undercarriage at the end of the winter.
  - Use professional service technicians or governmental inspection stations to annually inspect for corrosion.
  - Immediately seek an inspection of your vehicle if you become visually aware of corrosion flaking or scaling or if you become aware of a change in vehicle performance, such as soft or spongy brakes, fluids leaking, impairment of directional control, suspension noises or rattling metal straps.
  - NHTSA further advises that after a vehicle is 7 years old, it is essential that you take these indicated maintenance steps to ensure that you protect yourself from unsafe corrosion conditions.
-

## Owner maintenance precautions

Improper or incomplete service may result in problems. This section gives instructions only for the maintenance items that are easy to perform.

As explained earlier in this section, several procedures can be done only by an authorized Kia dealer with special tools.

### \* NOTICE

Improper owner maintenance during the warranty period may affect warranty coverage. For details, read the separate Warranty & Consumer Information manual provided with the vehicle. If you're unsure about any servicing or maintenance procedure, have it done by an authorized Kia dealer.

### ⚠ WARNING

#### Maintenance work

Do not wear jewelry or loose clothing while working under the hood of your vehicle with the engine running. These items can become entangled in moving parts, if you must run the engine while working under the hood, make certain that you remove all jewelry (especially rings, bracelets, watches, and necklaces) and all neckties, scarves, and similar loose clothing before getting near cooling fans.

### ⚠ WARNING

#### Touching metal parts

Do not touch metal parts (including strut bars) while the vehicle is operating or hot. Doing so could result in serious bodily injury. Turn the vehicle off and wait until the metal parts cool down to perform maintenance work on the vehicle.

## Owner maintenance

The following lists detail the vehicle checks and inspections that should be performed by the owner or an authorized Kia dealer. They should be performed at the indicated frequencies to help ensure the safe and dependable operation of your vehicle.

Any adverse conditions should be brought to the attention of your dealer as soon as possible.

These owner maintenance checks are generally not covered by warranties and you may be charged for labor, parts and lubricants used.

### When you stop for fuel:

- Check the coolant level in coolant reservoir.
- Check the windshield washer fluid level.
- Look for low or under-inflated tires. Check if the front of the radiator and condenser are clean and not blocked with leaves, dirt or insects etc. If any of the above parts are extremely dirty or you are not sure of their condition, take your vehicle to an authorized Kia dealer.

### ⚠ WARNING

#### Hot coolant



Be careful when checking your engine coolant level when the engine is hot. Scalding hot coolant and steam may blow out under pressure.

## **WARNING**

### Engine coolant reservoir cap



Do not remove the engine coolant reservoir cap when the engine is hot. This may result in coolant being blown out of the opening and cause serious burns.

### While operating your vehicle:

- Check for vibrations in the steering wheel. Notice any increased steering effort or looseness in the steering wheel, or change in its straight-ahead position.
- Notice if your vehicle constantly turns slightly or "pulls" to one side when traveling on smooth, level road.
- When stopping, listen and check for unusual sounds, pulling to one side, increased brake pedal travel or "hard-to-push" brake pedal.
- If any slipping or changes in the operation of your transmission occurs, take your vehicle to an authorized Kia dealer.
- Check the transmission P (Park) function.
- Check for fluid leaks under your vehicle (water dripping from the air conditioning system during or after use is normal).

### At least monthly:

- Check the coolant level in the coolant reservoir.
- Check the operation of all exterior lights, including the stoplights, turn signals and hazard warning flashers.

- Check the inflation pressures of all tires including the spare for tires that are worn, show uneven wear, or are damaged.
- Check for loose wheel lug nuts.

### At least once every 6 months:

- Check the radiator, heater and air conditioning hoses for leaks or damage.
- Check the windshield washer spray and wiper operation. Clean the wiper blades with clean cloth dampened with washer fluid.
- Check the headlight alignment.
- Check the lap/shoulder belts for wear and function.

### At least once a year:

- Clean the body and door drain holes.
- Lubricate the door hinges and check the hood hinges.
- Lubricate the door and hood locks and latches.
- Lubricate the door rubber weatherstrips.
- Check the air conditioning system.
- Inspect and lubricate automatic transmission linkage and controls.
- Clean the battery and terminals.
- Check the brake fluid level.
- Visually inspect steering, suspension, and chassis components for damaged, loose, or missing parts or signs of wear.

## Scheduled maintenance service

Follow the Normal maintenance schedule if the vehicle is usually operated where none of the following conditions apply.

Follow the Maintenance Under Severe Usage Conditions if any of the following conditions apply.

- Repeated driving short distance of less than 5 miles (8 km) in normal temperature or less than 10 miles (16 km) in freezing temperature.
- Extensive engine idling or low speed driving for long distances.
- Driving on rough, dusty, muddy, unpaved, graveled or salt-spread roads.
- Driving in areas using salt or other corrosive materials or in very cold weather.
- Driving in heavy dust condition.
- Driving in heavy traffic area.
- Driving on uphill, downhill, or mountain road repeatedly.
- Using for towing or camping and driving with loading on the roof.
- Driving as a patrol car, taxi, or other commercial use.
- Frequently driving under high speed or rapid acceleration/deceleration.
- Frequently driving in stop-and-go condition.

If your vehicle is operated in any of the prior listed conditions, you should inspect, replace or refill more frequently, using the severe usage maintenance schedule instead of the normal usage maintenance schedule.

### \* NOTICE

The vehicle may be equipped with the Oil Life Management System that predicts engine oil life based on the driver's driving history and alerts the driver to change engine oil.

- If the deterioration of the engine oil increases depending on the driver's driving severity, the remaining oil life alert appears on the instrument cluster before the normal engine oil replacement interval. Have the engine oil and filter be changed by an authorized Kia dealer.
- Oil Life Management System when the recommended engine oil is used. So, if recommended engine oil is not used, replace the engine oil according to the maintenance schedule under severe usage condition.

Also, check the amount of engine oil regularly as this system assumes that the engine oil is being filled normally.

- Always reset the remaining engine oil life whenever the engine oil is changed. Otherwise, the Oil Life Management System may not be accurate.

To reset the Oil Change Reminder, select 'Convenience → Oil Change Reminder → Reset' from the User Settings menu on the cluster or 'Vehicle → Cluster → Oil Change Reminder → Reset' from Settings menu on the Infotainment system screen.

- If there is no alert until the maximum maintenance interval, have vehicle be checked by an authorized Kia dealer.

**\* INFORMATION**

The infotainment system may change after software updates. For more information, refer to the user's manual provided in the infotainment system and the quick reference guide.

---

**\* NOTICE**

After 10 years or 100,000 miles (150,000 km), we recommend to use severe maintenance schedule.

---

### Normal maintenance schedule - Turbo Models

The following maintenance services must be performed to ensure good emission control and performance. Keep receipts for all vehicle services to protect your warranty. Where both mileage and date are shown, the frequency of service is determined by whichever occurs first.

I: Inspect and if necessary, adjust, correct, clean or replace.

R: Replace or change

		Number of months or driving distance, whichever comes first											
Months		12	24	36	48	60	72	84	96	108	120	132	144
Miles×1,000		8	16	24	32	40	48	56	64	72	80	88	96
Km×1,000		13	26	39	52	65	78	91	104	117	130	143	156
Tire rotation		Rotate every 8,000 miles (13,000 km)											
Fuel additives <sup>1</sup>		Add every 8,000 miles (13,000 km) or 12 months											
Engine oil and engine oil filter <sup>2</sup>	Smartstream G1.6 T-GDi	R	R	R	R	R	R	R	R	R	R	R	R
	Smartstream G2.5 T-GDi												
Climate control air filter		I	R	I	R	I	R	I	R	I	R	I	R
Air cleaner filter (Engine)		I	I	R	I	I	R	I	I	R	I	I	R
Brake fluid		Inspect every 8,000 miles (13,000 km) or 12 months, Replace every 48,000 miles (78,000 km) or 48 months											
Spark plugs		Replace every 48,000 miles (78,000 km)											
Coolant (Engine) <sup>3</sup>		At first, replace at 120,000 miles (195,000 km) or 120 months. After that, replace every 24,000 miles (39,000 km) or 24 months											
Air conditioner refrigerant													
Air conditioner compressor													
12V Battery condition													
Vacuum hose													
Brake discs and pads		I	I	I	I	I	I	I	I	I	I	I	I
Brake lines, hoses and connections													
Suspension ball joints													
Steering gear rack, linkage and boots													
Exhaust system													
Cooling system													
Intercooler in/out hose	Smartstream G1.6 T-GDi	I	-	I	-	I	-	I	-	I	-	I	-
	Smartstream G2.5 T-GDi												
Air intake hose		I	-	I	-	I	-	I	-	I	-	I	-
Drive shaft and boots													
Propeller shaft (AWD)													
Fuel tank and fuel cap		-	I	-	I	-	I	-	I	-	I	-	I
Fuel tank air filter													
Fuel lines, hoses and connections													

Number of months or driving distance, whichever comes first													
Months	12	24	36	48	60	72	84	96	108	120	132	144	
Miles×1,000	8	16	24	32	40	48	56	64	72	80	88	96	
Km×1,000	13	26	39	52	65	78	91	104	117	130	143	156	
Drive belts <sup>14</sup>	-	-	-	-	-								
Differential oil (rear) (AWD) <sup>15</sup>	Inspect every 40,000 miles (65,000 km) or 48 months												
Transfer case oil (AWD) <sup>16</sup>													
Dual clutch transmission (DCT) fluid (Wet type) <sup>7</sup>	Smartstream G2.5T-GDi	-	-	-		-	-	-		-	-	-	
Automatic transmission (AT) fluid <sup>4</sup>	Smartstream G1.6T-GDi	No service required											

**\*1. Fuel additives**

Fuel additives: Kia recommends that you use Tier 1 unleaded gasoline which has an octane rating of  $((R+M)/2)$  of 87 (Research Octane Number 91) or higher. For customers who do not use good quality gasolines including fuel additives regularly, and have problems starting or the engine does not run smoothly, one bottle of additives should be added to the fuel tank at every 8,000 miles (13,000 km). Additives are available from an authorized Kia dealer. Do not mix with other additives.

**\*2. Engine oil and engine oil filter**

As it is normal for engine oil to be consumed during driving, the engine oil level should be checked on regular basis. The engine oil change interval for normal operating conditions is based on the use of the recommended engine specification. If the recommended engine oil specification is not used, then replace the engine oil according to the maintenance schedule under severe operating conditions.

Never add any additives to the engine oil. Engine oil additives can change the properties of engine oil and may cause serious engine failure.

**\*3. Coolant (Engine)**

When adding coolant, use only deionized water or soft water for your vehicle and never mix hard water in the coolant filled at the factory. An improper coolant mixture can result in serious malfunction or engine damage.

**\*4. Drive belts (Engine)**

Inspect alternator, water pump and air conditioner drive belt and if necessary, repair or replace. Inspect drive belt tensioner, idler and alternator pulley and if necessary correct or replace.

**\*5. Differential oil (rear) (AWD)**

If the vehicle has been submerged in water or in a flooded area, the fluids should be changed as a precaution.

**\*6. Transfer case oil (AWD)**

If the vehicle has been submerged in water or in a flooded area, the fluids should be changed as a precaution.

**\* Transmission fluid**

If the vehicle has been submerged in water or in a flooded area, the fluids should be changed as a precaution.

**Fuel filter (gasoline engine)**

The fuel filter is considered to be maintenance free but periodic inspection is recommended for this maintenance schedule depends on fuel quality.

- If there are some important safety matters like fuel flow restriction, surging, loss of power, hard starting problem etc, replace the fuel filter immediately regardless of maintenance schedule and consult an authorized Kia dealer for details.



### Maintenance Under Severe Usage Conditions - Turbo Models

The following items must be serviced more frequently on cars mainly used under severe driving conditions. Refer to the chart below for the appropriate maintenance intervals.

R: Replace

I: Inspect and if necessary, adjust, correct, clean or replace

Maintenance item		Maintenance operation	Maintenance intervals	Driving condition
Engine oil and engine oil filter	Smartstream G1.6 T-GDi	R	Every 5,000 miles (8,000 km) or 6 months	D, H, I
	Smartstream G2.5 T-GDi	R	Every 5,000 miles (8,000 km) or 6 months	D, H, I
Automatic transmission (AT) fluid	Smartstream G1.6 T-GDi	R	Every 56,000 miles (91,000 km)	A, C, F, G, H, I, J, K
Dual clutch transmission (DCT) fluid	Smartstream G2.5 T-GDi	R	Every 56,000 miles (91,000 km)	A, C, D, E, F, G, H, I, J, K
Transfer case oil (AWD)		R	Every 72,000 miles (117,000 km)	C, E, G, H, I, J
Differential oil (rear) (AWD)		R	Every 72,000 miles (117,000 km)	C, E, G, H, I, J
Climate control air filter		R	More frequently	C, E, G
Air cleaner filter		R	More frequently	C, E
Spark plugs		R	More frequently	A, B, F, G, H, I, K
Brake discs and pads and calipers		I	More frequently	C, D, E, G, H, I, J, K
Suspension ball joints		I	More frequently	C, D, E, G, H, I
Steering gear rack, linkage and boots		I	More frequently	C, D, E, F, G, H, I
Drive shafts and boots		I	More frequently	C, D, E, F, G, H, I, J
Propeller shaft (AWD)		I	More frequently	C, D, E, F, G, H, I, J

### Severe Driving Conditions

A: Repeatedly driving short distance of less than 5 miles (8 km) in normal temperature or less than 10 miles (16 km) in freezing temperature.

B: Extensive engine idling or low speed driving for long distances.

C: Driving on rough, dusty, muddy, unpaved, graveled or saltspread roads.

D: Driving in areas using salt or other corrosive materials or in very cold weather.

E: Driving in heavy dust condition.

F: Driving in heavy traffic area.

G: Driving on uphill, downhill, or mountain road repeatedly.

H: Using for towing or camping and driving with loading on the roof.

I: Driving as a patrol car, taxi, other commercial use or vehicle towing.

J: Frequently driving under high speed or rapid acceleration/deceleration.

K: Frequently driving in stop-and-go conditions.

## Explanation of scheduled maintenance items

The following parts require scheduled maintenance.

### Engine oil and filter

The engine oil and filter should be changed at the intervals specified in the maintenance schedule. If the vehicle is being driven in severe conditions, more frequent oil and filter changes are required.

### Drive belts

Inspect all drive belts for evidence of cuts, cracks, excessive wear or oil saturation and replace if necessary. Drive belts should be checked periodically for proper tension and adjusted as necessary.

#### CAUTION

When you are inspecting the belt, place the ignition switch or ENGINE START/STOP button in the LOCK/OFF or ACC position.

### Fuel filter

Kia gasoline vehicles are equipped with a lifetime fuel filter that is integrated with the fuel tank. Regular maintenance or replacement is generally not needed. This may vary depending on fuel quality. If you experience any of the following: fuel flow restriction, surging, loss of power, or a hard starting issue, inspection and, if necessary, replacement may be needed. Have the fuel filter inspected or replaced by an authorized Kia dealer.

### Fuel lines, fuel hoses and connections

Check the fuel lines, fuel hoses and connections for leakage and damage. Have an authorized Kia dealer replace any damaged or leaking parts immediately.

### Fuel tank and fuel cap

The fuel tank and fuel cap should be inspected at those intervals specified in the maintenance schedule. Make sure that a new fuel tank or fuel cap is correctly replaced.

### Vacuum crankcase ventilation hoses

Inspect the surface of hoses for evidence of heat and/or mechanical damage. Hard and brittle rubber, cracking, tears, cuts, abrasions, and excessive swelling indicate deterioration. Particular attention should be paid to examine those hose surfaces nearest to high heat sources, such as the exhaust manifold. Inspect the hose routing to assure that the hoses do not come in contact with any heat source, sharp edges or moving components which might cause heat damage or mechanical wear. Inspect all hose connections, such as clamps and couplings, to make sure they are secure, and that no leaks are present. Hoses should be replaced immediately if there is any evidence of deterioration or damage.

### Air cleaner filter

A Genuine Kia air cleaner filter is recommended when the filter is replaced.

## Spark plugs

Make sure to install new spark plugs of the correct heat range.

When assembling parts, be sure to wipe the inside and outside of the boot bottom of the ignition coil and the insulator of the spark plug with a soft cloth to prevent contamination of the spark plug insulator.

### **⚠ WARNING**

Do not disconnect and inspect spark plugs when the engine is hot. You may burn yourself.

## Automatic transmission (AT) fluid

Automatic transmission fluid should not be checked under normal usage conditions. But in severe conditions, the fluid should be changed at an authorized Kia dealer in accordance to the scheduled maintenance at the beginning of this chapter (Refer to the "Maintenance Under Severe Usage Conditions - Turbo Models" on page 8-14).

### **\* NOTICE**

Automatic transmission fluid color is usually red. As the vehicle is driven, the automatic transmission fluid will begin to look darker.

It is the normal condition and you should not judge the need to replace the fluid based upon the changed color.

### **⚠ CAUTION**

#### **Transmission fluids**

The use of a non-specified fluid could result in transmission malfunction and failure. Use only specified automatic transmission fluid. (Refer to "Recom-

mended lubricants and capacities" on page 9-9.)

## Dual clutch transmission (DCT) fluid

Inspect the dual clutch transmission fluid according to the maintenance schedule.

## Cooling system

Check the cooling system components, such as the radiator, coolant reservoir, hoses and connections for leakage and damage. Replace any damaged parts.

## Coolant

The coolant should be changed at the intervals specified in the maintenance schedule.

## Brake hoses and lines

Visually check for proper installation, chafing, cracks, deterioration and any leakage. Replace any deteriorated or damaged parts immediately.

### **\* NOTICE**

#### **NHTSA Safety Corrosion Alert**

NHTSA has warned all vehicle owners of all brands that they must maintain their vehicles in a manner which will prevent brake hose and brake line failures due to corrosion when such vehicles are exposed to winter road salt and related chemicals. While serious corrosion conditions typically only manifest themselves as safety issues after 7 years of vehicle use, the corrosion process starts immediately and thus underbody cleaning maintenance must commence from your vehicle's first exposure to road salts and chemicals. NHTSA urges vehicle

owners to take the following steps to prevent corrosion:

1. Wash the undercarriage of your vehicle regularly throughout the winter and do a thorough washing in the spring to remove road salt and other de-icing chemicals.
2. Monitor the brake system for signs of corrosion by having regular professional inspections and watching for signs of problems, including loss of brake fluid, unusual leaks and soft or spongy feel in the brake pedal.
3. Replace the entire brake pipe assembly if you find severe corrosion that causes scaling or flaking of brake components.

### Brake fluid

Check the brake fluid level in the brake fluid reservoir. The level should be between "MIN" and "MAX" marks on the side of the reservoir. Use only hydraulic brake fluid conforming to DOT 4 specification.

### Parking brake

Inspect the parking brake system including the parking brake lever (or pedal) and cables.

### Exhaust pipe and muffler

Visually inspect the exhaust pipes, muffler and hangers for cracks, deterioration, or damage. Start the engine and listen carefully for any exhaust gas leakage. Tighten connections or replace parts as necessary.

### Brake discs, pads and calipers

Check the pads for excessive wear, discs for run out and wear, and calipers for fluid leakage.

### Suspension mounting bolts

Check the suspension connections for looseness or damage. Retighten to the specified torque.

### Steering gear box, linkage & boots/lower arm ball joint

With the vehicle stopped and off, check for excessive free-play in the steering wheel.

Check the linkage for bends or damage. Check the dust boots and ball joints for deterioration, cracks, or damage. Replace any damaged parts.

### Drive shafts and boots

Check the drive shafts, boots and clamps for cracks, deterioration, or damage. Replace any damaged parts and, if necessary, repack the grease.

### Air conditioning refrigerant

Check the air conditioning lines and connections for leakage and damage.

### Checking fluid levels

When checking engine oil, engine coolant, brake fluid, and washer fluid, always be sure to clean the area around any filler plug, drain plug, or dipstick before checking or draining any lubricant or fluid. This is especially important in dusty or sandy areas and when the vehicle is used on unpaved roads. Cleaning the plug and dipstick areas will prevent dirt and grit from entering the engine

and other mechanisms that could be damaged.

## Engine oil and filter

### Checking the engine oil level

Engine oil is used for lubricating, cooling, and operating various hydraulic components in the engine. Engine oil consumption while driving is normal, and it is necessary to check and refill the engine oil regularly. Also, check and refill the oil level within the recommended maintenance schedule to prevent deterioration of oil performance. Check the engine oil following the below procedure.

1. Be sure the vehicle is on level ground.
2. Start the engine and allow it to reach normal operating temperature.

### **⚠ WARNING**

#### Radiator hose

Be very careful not to touch the radiator hose when checking or adding the engine oil as it may be hot enough to burn you.

3. Turn the engine off, remove the oil filler cap and pull the dipstick out. Wait for 15 minutes for the oil to return to the oil pan.

Smartstream G1.6 T-GDi

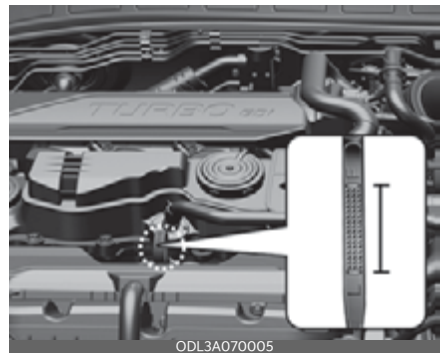

Smartstream G2.5 T-GDi

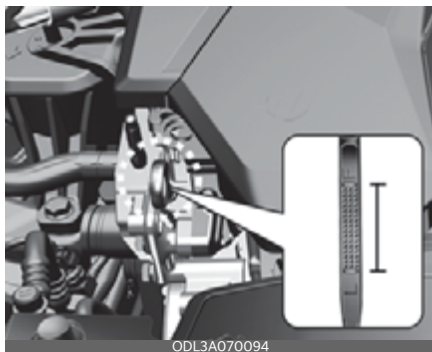

4. Wipe the dipstick clean and re-insert it fully.
5. Pull the dipstick out again and check the level. Check if the oil level is between the F-L line, and if it is below the L line, add enough oil to bring the level to F line.

#### **⚠ CAUTION**

When you wipe the oil level gauge, you should wipe it with a clean cloth. When mixed with debris, it can cause engine damage.

Smartstream G1.6 T-GDi

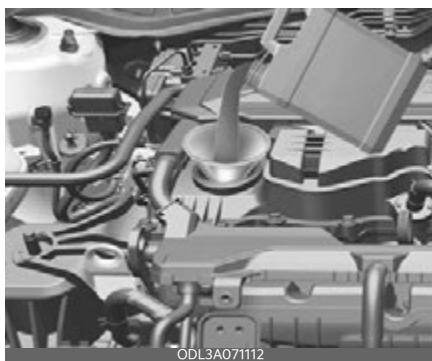

Smartstream G2.5 T-GDi

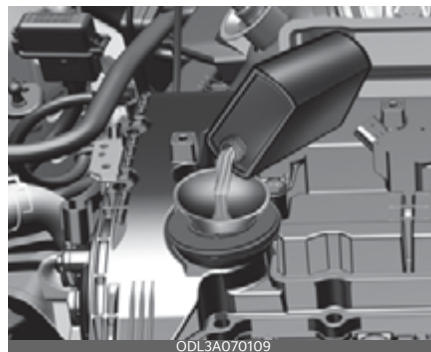

#### **Use a funnel to help prevent oil from being spilled on engine components.**

Use only the specified engine oil. (Refer to "Recommended lubricants and capacities" on page 9-9.)

- Do not spill engine oil when adding or changing engine oil. Wipe off spilled oil immediately.
- The engine oil consumption may increase while you break in a new vehicle and it will be stabilized after driving 4,000 miles (6,000 km).
- The engine oil consumption can be affected by driving habits, climate conditions, traffic conditions, oil quality, etc. Therefore, it is recommended that you inspect the engine oil level regularly and refill it if necessary.

#### **Changing the engine oil and filter**

The lubrication, rust prevention, cooling, and cleaning effect of the engine oil will gradually degrade during its use. Have the engine oil and filter changed by an authorized Kia dealer according to the Engine Oil Life Management System instructions or the maintenance schedule.

- If the maintenance schedule to replace engine oil is exceeded, the

engine oil performance may deteriorate, and the engine condition may be affected. Therefore, replace the engine oil according to the maintenance schedule.



- To keep the engine in optimal condition, use the recommended engine oil and filter. If the recommended engine oil and filter are not used replace it according to the maintenance schedule under severe usage conditions.
- The purpose of the maintenance schedule for engine oil replacement is to prevent oil deterioration and it is irrelevant to oil consumption. Check and refill engine oil regularly.

### **⚠ WARNING**

#### **Used engine oil**

Used engine oil may cause irritation or cancer of the skin if left in contact with the skin for prolonged periods of time. Used engine oil contains chemicals that have caused cancer in laboratory animals. Always protect your skin by washing your hands thoroughly with soap and warm water as soon as possible after handling used oil. Do not leave used engine oil within the reach of children.

### **\* NOTICE**

When the oil pressure is low due to insufficient engine oil, the Engine Oil Pressure () warning light will appear. In addition, the enhanced engine protection system, which limits the engine's power is activated and the Malfunction Indicator Lamp () will appear when the vehicle is driven in this state continuously.

When the engine oil pressure is restored, the warning light and the enhanced

engine protection system will turn off after the engine is restarted.

### **⚠ CAUTION**

The engine oil is very hot immediately after the vehicle has been driven and can cause burns during replacement. Replace the engine oil after the engine oil has cooled down.

### **\* NOTICE**

Never add any additives to the engine oil. Engine oil additives can change the properties of engine oil and may cause serious engine failure.

## Engine coolant

The high-pressure cooling system has a reservoir filled with year round anti-freeze coolant. The reservoir is filled at the factory.

Check the antifreeze protection and coolant level at least once a year, at the beginning of the winter season, and before traveling to a colder climate.

### ⚠ CAUTION

- When the engine overheats from low engine coolant, suddenly adding engine coolant may cause cracks in the engine. To prevent damage, add engine coolant slowly in small quantities.
- Do not drive with no engine coolant. It may cause water pump failure and engine seizure, etc.

### ⚠ WARNING

#### Engine coolant reservoir cap



Never attempt to remove the engine coolant reservoir cap while the engine is operating or hot. Doing so might lead to damage to the cooling system and engine, and could result in serious bodily injury from the escaping hot coolant or steam.

#### Recommended coolant

When adding coolant, use only deionized water or soft water for your vehicle and never mix hard water in the coolant filled at the factory. An improper coolant mixture can result in serious malfunction or damage.

- Do not use alcohol or methanol coolant or mix them with the specified coolant.

- The engine in your vehicle has aluminum engine parts and must be protected by an ethylene-glycol with phosphate based coolant to prevent corrosion and freezing.
- Do not use a solution that contains more than 60% antifreeze or less than 35% antifreeze, which would reduce the effectiveness of the solution.
- The cooling circuit of a vehicle equipped with a heat pump system may freeze in extremely low temperature when the concentration of the antifreezing liquid is below 45%.

For mixture percentage, refer to the following table.

Ambient Temperature	Mixture Percentage (volume)	
	Antifreeze	Water
5 °F (-15 °C)	35	65
-13 °F (-25 °C)	40	60
-31 °F (-35 °C)	50	50
-49 °F (-45 °C)	60	40

### ⚠ WARNING



#### Engine coolant reservoir cap

Do not remove the engine coolant reservoir cap when the engine and engine coolant reservoir are hot. Scalding hot coolant and steam may blow out under pressure which may result in serious injury.



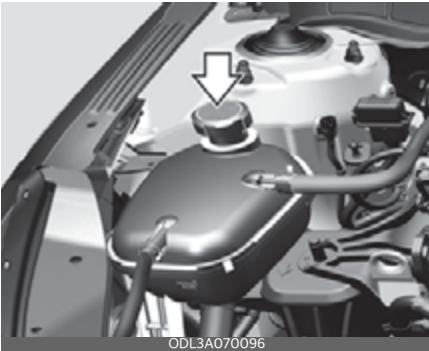

ODL3A070096

**\* NOTICE**

Make sure the engine coolant reservoir cap is properly closed after refill or coolant.

Otherwise the engine could be overheated while driving.

- 1. Check if the engine coolant reservoir cap label is straight In front.

Engine room front view



ODL3A070108

- 2. Make sure that the tiny protrusions inside the coolant cap are securely interlocked.

Engine room rear view



ODL3A070009

**Checking the coolant level**

**⚠ WARNING**



**Removing engine coolant reservoir cap**

Never attempt to remove the engine coolant reservoir cap

while the engine is operating or hot. Doing so might lead to cooling system damage and could result in serious personal injury from escaping hot coolant or steam.

- 1. Turn the vehicle off and wait until it cools down.
- 2. Use extreme care when removing the engine coolant reservoir cap. Wrap a thick towel around it, and turn it counterclockwise slowly to the first stop.
- 3. Step back while the pressure is released from the cooling system.
- 4. When you are sure all the pressure has been released, press down on the cap, using a thick towel, and continue turning counterclockwise to remove it.

**WARNING****Cooling fan**

Use caution when working near the blade of the cooling fan. The electric motor

(cooling fan) is controlled by coolant temperature, refrigerant pressure and vehicle speed. It may sometimes operate even when the vehicle is not running.

5. Check the condition and connections of all cooling system hoses and heater hoses.
6. Replace any swollen or deteriorated hoses.
7. Check the coolant level. The coolant level should be filled between MAX and MIN marks on the side of the coolant reservoir when the engine room is cool.

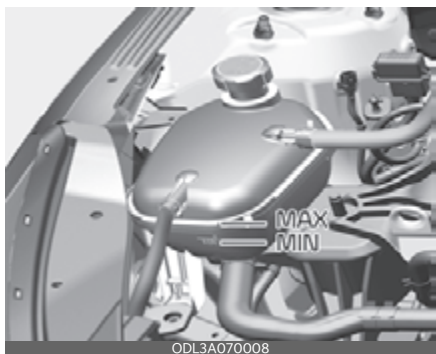

8. If the coolant level is low, add enough specified coolant to provide protection against freezing and corrosion. Bring the level to MAX, but do not overfill.

If frequent additions are required, see an authorized Kia dealer for a cooling system inspection.

**Changing the coolant**

Have the coolant changed by an authorized Kia dealer according to the Maintenance Schedule, refer to "Scheduled maintenance service" on page 8-9.

**CAUTION**

Put a thick cloth or fabric around the engine coolant reservoir cap before refilling the coolant in order to prevent the coolant from overflowing into engine parts such as the alternator.

## Brake fluid

The brake fluid acts to transmit force to the brake when the driver depresses the brake pedal. Brake fluid must be maintained periodically to ensure that the brakes operate smoothly.

### Checking the brake fluid level

Check the fluid level in the reservoir periodically. The fluid level should be between MAX and MIN marks on the side of the reservoir.

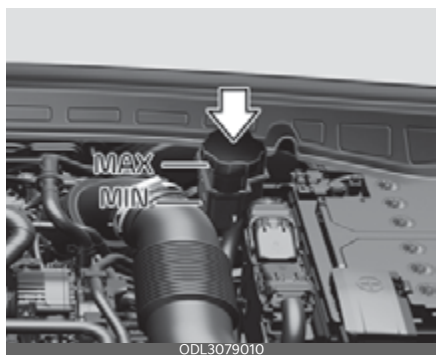

1. Before removing the reservoir cap and adding brake fluid, clean the area around the reservoir cap thoroughly to prevent brake fluid contamination.
2. Periodically check that the fluid level in the brake fluid reservoir is between MIN and MAX. The level will fall with accumulated mileage. This is a normal condition associated with the wear of the brake linings. If the fluid level is excessively low, have the brake system checked by an authorized Kia dealer.

Use only the specified brake fluid. (Refer to "Recommended lubricants and capacities" on page 9-9.)

Never mix different types of fluid.

### ⚠ WARNING

In the event the brake system requires frequent additions of fluid, the vehicle should be inspected by an authorized Kia dealer.

### ⚠ WARNING

When changing and adding brake fluid, handle it carefully. Do not let it come in contact with your eyes. If brake fluid should come in contact with your eyes, immediately flush them with a large quantity of fresh tap water. Have your eyes examined by a doctor as soon as possible.

### ⚠ CAUTION

#### Proper fluid

Only use brake fluid in the brake system. Even small amounts of improper fluids can cause damage to the brake system.

### ⚠ CAUTION

#### Brake fluid

Do not allow brake fluid to contact the vehicle's body paint, as paint damage will result.

The brake fluid constantly absorbs moisture from the air. This lowers the boiling point of the brake fluid. If the boiling point is too low, vapor pockets may form in the brake system when the brakes are applied hard.

Brake fluid, which has been exposed to open air for an extended time should never be used as its quality cannot be guaranteed. It should be disposed of properly.

**⚠ CAUTION**

To maintain your vehicle's best brake and ABS/ESC performance, use Kia genuine brake fluid as in the specification. (Classification : SAE J1704 DOT-4 LV, ISO4925 CLASS-6, FMVSS116 DOT-4)

**⚠ CAUTION****Washer fluid**

- Do not use radiator coolant or anti-freeze in the washer fluid reservoir. Radiator coolant can severely obscure visibility when sprayed on the windshield and may cause loss of vehicle control or damage to paint and body trim. Windshield Washer fluid agents contain some amounts of alcohol and can be flammable under certain circumstances. Do not allow sparks or flame to contact the washer fluid or the washer fluid reservoir. Damage to the vehicle or occupants could occur.
- Windshield washer fluid is poisonous to humans and animals. Do not drink and avoid contacting windshield washer fluid. Serious injury or death could occur.

**Washer fluid**

Washer fluid is used when wiping the windshield of the vehicle with a windshield wiper. You should check and refill washer fluid periodically to make sure that it doesn't run out.

**Checking the washer fluid level**

The reservoir is translucent so that you can check the level with a quick visual inspection.

- Check the fluid level in the washer fluid reservoir and add fluid if necessary. Plain water may be used if washer fluid is not available. However, use washer solvent with antifreeze characteristics in cold climates to prevent freezing.

**⚠ WARNING****Flammable Fluid**

Do not allow the washer fluid to come in contact with open flames or sparks. The windshield washer fluid reservoir is flammable under certain circumstances. This can result in a fire.

**⚠ WARNING****Coolant**

- Do not use radiator coolant or anti-freeze in the washer fluid reservoir.
- Radiator coolant can severely obscure visibility when sprayed on the windshield and may cause loss of vehicle control.

**⚠ WARNING****Windshield fluid**

Do not drink the windshield washer fluid. The windshield washer fluid is poisonous to humans and animals.

**Air cleaner filter****Replacing air cleaner filter**

Air cleaner filter must be replaced when necessary, and should not be washed.

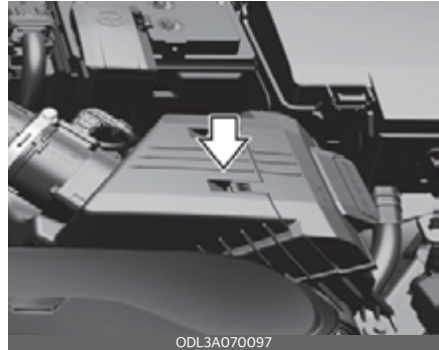

You can clean the filter when inspecting the air cleaner compartment. Clean the filter by using compressed air.

1. Pull up the lever (1) on the air cleaner cover and release the lock.



2. Pull up the air cleaner cover (2) and open.



3. Rotate the fixed lever on the filter and loosen the lock.



4. Replace the air cleaner filter.



5. Assemble in reverse order.  
Replace the filter according to the Maintenance Schedule.

### \* NOTICE

If the vehicle is operated in extremely dusty or sandy areas, replace the element more often than the usual recommended intervals. (Refer to "Maintenance Under Severe Usage Conditions - Turbo Models" on page 8-14.)

### ⚠ CAUTION

#### Air filter maintenance

- Do not drive with the air cleaner removed; this will result in excessive engine wear.
- When removing the air cleaner filter, be careful that dust or dirt does not enter the air intake, or damage may result.
- Use a Kia genuine part. Use of a non-genuine part could damage the air flow sensor.

## Climate control air filter

The climate control air filter should be replaced according to the maintenance schedule. If the vehicle is operated in severely air-polluted cities or on dusty rough roads for a long period, it should be inspected more frequently and replaced earlier.

### Inspecting and replacing climate control air filter

When you replace the climate control air filter, replace it performing the following procedure. Be careful to avoid damaging other components.

1. Open the glove box.
2. Remove the support rod (1).

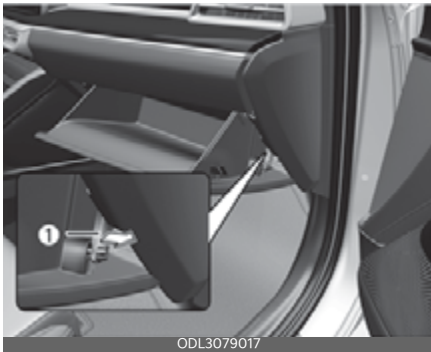

3. Push in both sides of the glove box as shown. This will ensure that the glove box stopper pins will get released from its holding location allowing the glove box to hang.

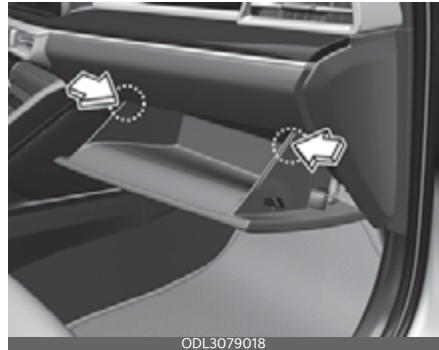

4. Remove the climate control air filter cover by pulling out right side of the cover.



5. Replace the climate control air filter.



6. Reassemble in the reverse order of disassembly.

**\* NOTICE**

When replacing the climate control air filter install it properly. Otherwise, the system may produce noise and the effectiveness of the filter may be reduced.

**Wiper blades**

When the wipers no longer clean adequately, the blades may be worn or cracked, and require replacement.

To prevent damage to the wiper arms or other components, do not attempt to move the wipers manually.

The use of a non-specified wiper blade could result in a wiper malfunction and failure.

**Blade inspection**

ODL3A07111

**\* NOTICE**

Commercial hot waxes applied by automatic vehicle washes have been known to make the windshield difficult to clean.

Contamination of either the windshield or the wiper blades with foreign matter can reduce the effectiveness of the windshield wipers. Common sources of contamination are insects, tree sap, and hot wax treatments used by some commercial vehicle washes. If the blades are not wiping properly, clean both the window and the blades with a good cleaner or mild detergent, and rinse thoroughly with clean water.



**⚠ CAUTION**

To prevent damage to the wiper blades, do not use gasoline, kerosene, paint thinner, or other solvents on or near them.

**Front windshield wiper blade**

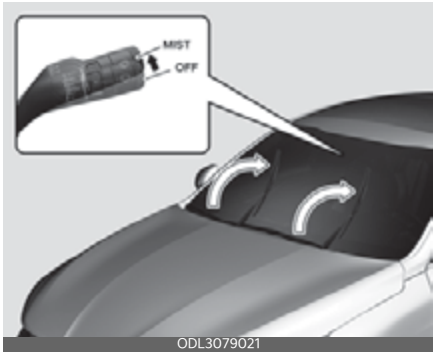

This vehicle has a "hidden" wiper design which means that the wipers cannot be lifted when they are in their bottom resting position.

1. Within 20 seconds of turning off the engine, lift and hold the wiper lever up to the MIST (or down to the ) position for about 2 seconds until the wipers move to the top wipe position.

At this time you can lift the wipers off the windshield.

2. Gently put the wipers back down onto the windshield.
3. Turn the wipers to any ON position to return the wipers to the bottom resting position.

**Blade replacement**

When the wipers no longer clean adequately, the blades may be worn or cracked, and require replacement.

1. Raise the wiper arm.

2. Lift up (1) the wiper blade clip. Then pull down (2) the blade assembly and remove it.

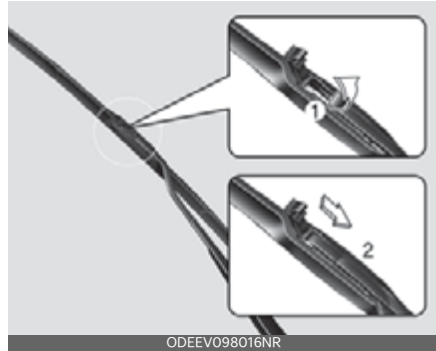

3. Install the new blade assembly.



4. Return the wiper arm on the windshield.

**⚠ CAUTION**

**Wiper arms**

- Do not allow the wiper arm to fall against the windshield, since it may chip or crack the windshield.
- Do not pull the wiper arm forward, since arm could chip hood paint.

## Battery

The battery powers the engine in order to move the vehicle as well as supplying power to the various devices installed in the vehicle.

### For best battery service

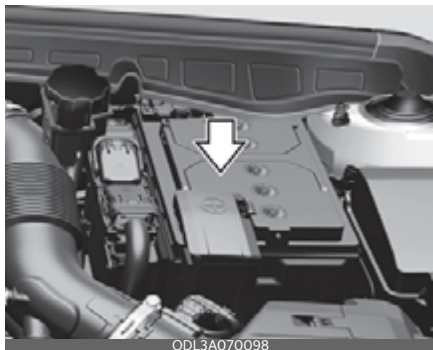

- Keep the battery securely mounted.
- Keep the battery top clean and dry.
- Keep the terminals and connections clean, tight, and coated with petroleum jelly or terminal grease.
- Rinse any spilled electrolyte from the battery immediately with a solution of water and baking soda.
- If the vehicle is not going to be used for an extended time, disconnect the battery cables.

#### **WARNING**

#### Risk of explosion



Keep lit cigarettes and all other flames or sparks away from the battery.



The battery contains hydrogen -- a highly combustible gas which will explode if it comes in contact with a flame or

spark.



Keep batteries out of the reach of children because batteries contain highly corrosive SULFURIC ACID and electrolytes.

Do not allow battery acid to contact your skin, eyes, clothing or paint finish.



Wear eye protection when charging or working near a battery. Always provide ventilation when working in an

enclosed space.



Always read the following instructions carefully when handling a battery.



If any electrolyte gets into your eyes, flush your eyes with clean water for at least 15 minutes and get immediate medi-

cal attention. If electrolyte gets on your skin, thoroughly wash the contacted area. If you feel pain or burning sensation, get medical attention immediately.



An inappropriately disposed battery can be harmful to the environment and human health. Dispose the battery

according to your local law(s) or regulation.



The battery contains lead. Do not dispose of it after use.

Please return the battery to an authorized Kia dealer to be

recycled.

Never attempt to recharge the battery when the battery cables are connected.

#### **WARNING**

#### Risk of electrocution

Never touch the electrical ignition system while the vehicle is running. This system works with high voltage, which can "zap" you.

### \* NOTICE

If you connect unauthorized electronic devices to the battery, the battery may be discharged. Never use unauthorized devices.

### ⚠ WARNING

#### Recharging battery

Never attempt to recharge the battery when the battery cables are connected.

### ⚠ WARNING

#### Battery lead compound

Battery posts, terminals, and related accessories contain lead and lead compounds. Wash hands after handling.

### \* NOTICE

Your vehicle is equipped with maintenance free battery. If your vehicle is equipped with the battery marked with LOWER and UPPER on the side, you can check the electrolyte level. The electrolyte level should be between LOWER and UPPER. If the electrolyte level is low, it needs to add distilled (demineralized) water (Never add sulfuric acid or other electrolyte). When refill, be careful not to splash the battery and adjacent components. And do not overfill the battery cells. It can cause corrosion on other parts. Make sure that the cell caps are tightened. Contact an authorized Kia dealer.

#### Battery recharging

Your vehicle has a maintenance-free, calcium-based battery

- If the battery becomes discharged in a short time (because, for example, the

headlights or interior lights were left on while the vehicle was not in use), recharge it by slow charging (trickle) for 10 hours.

- If the battery gradually discharges because of high electric load while the vehicle is being used, recharge it at 20~30 A for two hours.

When recharging the battery, observe the following precautions:

- The battery must be removed from the vehicle and placed in an area with good ventilation.
- Do not allow cigarettes, sparks, or flame near the battery.
- Watch the battery during charging, and stop or reduce the charging rate in following cases:
  1. the battery cells begin gassing (boiling) violently
  2. the electrolyte temperature of any cell exceeds 120 °F (49 °C).
- Wear eye protection when checking the battery during charging.
- Before performing maintenance or recharging the battery, turn off all accessories and stop the vehicle.
- Disconnect the battery charger in the following order.
  1. Turn off the battery charger main switch.
  2. Unhook the negative clamp from the negative battery terminal.
  3. Unhook the positive clamp from the positive battery terminal.
- The negative battery cable must be removed first and installed last when the battery is disconnected.

## CAUTION

### AGM battery

- Absorbent Glass Mat (AGM) batteries are maintenance free and have the AGM battery serviced by an authorized Kia dealer.

For charging your AGM battery, use only fully automatic battery chargers that are specially developed for AGM batteries.

- When replacing the AGM battery, use parts for replacement from an authorized Kia dealer.
- Do not open or remove the cap on top of the battery. This may cause leaks of internal electrolyte that could result in severe injury.

### Reset items

The following items should be reset after the battery has been discharged or the battery has been disconnected.

- Auto up/down window (Refer to "Window opening and closing" on page 4-33)
- Trip computer (Refer to "Trip information (trip computer)" on page 4-78)
- Climate control system (Refer to "Automatic climate control system" on page 4-111)
- Sunroof (Refer to "Panoramic sunroof (if equipped)" on page 4-42)

## Tires and wheels

For proper maintenance, safety, and maximum fuel economy, you must always maintain the recommended tire inflation pressures and stay within the load limits and weight distribution recommended for your vehicle.

### Recommended cold tire inflation pressures

All tire pressures should be checked when the tires are cold. "Cold Tires" means the vehicle has not been driven for at least three hours or driven less than 1 mile (1.6 km).

Recommended pressures must be maintained for the best ride, vehicle handling, and minimum tire wear.

For recommended inflation pressure, refer to "Tires and wheels" on page 9-8.

All specifications (sizes and pressures) can be found on a label attached to the driver's side center pillar.



### **⚠ WARNING**

#### **Tire underinflation**

Inflate your tires consistent with the instructions provided in this manual. Regularly check the tire inflation pressure, and correct it as needed; at least twice a month and before any long trips on the road. If you fail to observe this precaution, you may be driving on underinflated tires, which may not only compromise your vehicle's driving stability, but may also lead to tire damage and the risk of an accident. This risk is much higher on hot days and when driving for long periods at high speeds.

Failure to maintain specified pressure may result in excessive wear, poor handling, reduced fuel economy, deformation of tire and/or wheel, harsh ride conditions, possibility for additional

damage from road hazards, or result in tire failure.

#### **Tire pressure**

Always observe the following:

- Check tire pressure when the tires are cold. (After vehicle has been parked for at least three hours or hasn't been driven more than 1 mile (1.6 km) since startup.)
- Check the pressure of your spare tire each time you check the pressure of other tires.
- Never overload your vehicle. Be careful not to overload a vehicle luggage rack if your vehicle is equipped with one.
- Warm tires normally exceed recommended cold tire pressures by 4~6 psi (28~41 kPa). Do not release air from warm tires to adjust the pressure or the tires will be underinflated.

### **⚠ WARNING**

#### **Tire Inflation**

Overinflation or underinflation can reduce tire life, adversely affect vehicle handling, and lead to sudden tire failure. This could result in loss of vehicle control and potential injury.

## Checking tire inflation pressure

Check your tires once a month or more.

Use a good quality gauge to check tire pressure. You cannot tell if your tires are properly inflated simply by looking at them. Radial tires may look properly inflated even when they're underinflated.

Check the tire's inflation pressure when the tires are cold. "Cold" means your vehicle has been sitting for at least three hours or driven no more than 1 mile (1.6 km).

1. Remove the valve cap from the tire valve stem.
2. Press the tire gauge firmly onto the valve to get a pressure measurement. If the cold tire inflation pressure matches the recommended pressure on the tire and loading information label, no further adjustment is necessary.
3. If the pressure is low, add air until you reach the recommended amount.
4. If you overfill the tire, release air by pushing on the metal stem in the center of the tire valve.
5. Recheck the tire pressure with the tire gauge.

6. Be sure to put the valve caps back on the valve stems. They help prevent leaks by keeping out dirt and moisture.

Inspect your tires frequently for proper inflation as well as wear and damage. Always use a tire pressure gauge.

Tires with too much or too little pressure wear unevenly. This could result in poor handling, loss of vehicle control, and sudden tire failure leading to accidents, injuries, and even death. The recommended cold tire pressure for your vehicle can be found in this manual and on the tire label located on the driver's side center pillar.

## Tire rotation

To equalize tread wear, it is recommended that the tires be rotated every 8,000 miles (13,000 km) or sooner if irregular wear develops.

During rotation, check the tires for correct balance.

When rotating tires, check for uneven wear and damage.

Abnormal wear is usually caused by incorrect tire pressure, improper wheel alignment, out-of-balance wheels, severe braking or severe cornering. Look for bumps or bulges in the tread or side of tire. Replace the tire if you

find either of these conditions. Replace the tire if fabric or cord is visible. After rotation, be sure to bring the front and rear tire pressures to specification and check lug nut tightness. (proper torque is 79~94 lbf·ft [11~13 kgf·m])

Refer to "Tires and wheels" on page 9-8.

Disc brake pads should be inspected for wear whenever tires are rotated.

With a full-size spare tire (if equipped)

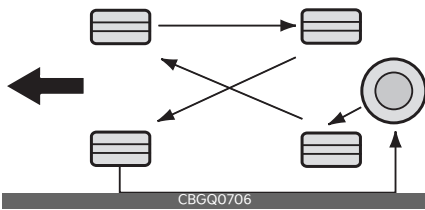

Without a spare tire

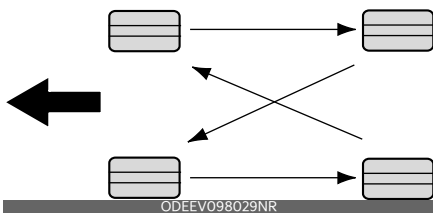

Directional tires (if equipped)

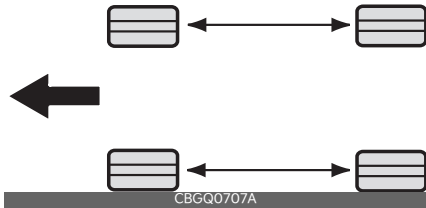

Rotate radial tires that have an asymmetric tread pattern only from front to rear and not from right to left.

**⚠ WARNING**

**Mixing tires**

- Do not use the compact spare tire for the tire rotation.
- Do not mix bias ply and radial ply tires under any circumstances. This may cause unusual handling characteristics.

**Wheel alignment and tire balance**

The wheels on your vehicle were aligned and balanced carefully at the factory to give you the longest tire life and best overall performance.

If you notice unusual tire wear or your vehicle pulling one way or the other, the alignment may need to be reset.

If you notice your vehicle vibrating when driving on a smooth

road, your wheels may need to be rebalanced.

### ⚠ CAUTION

#### Wheel weight

Improper wheel weights can damage your vehicle's aluminum wheels. Use only approved wheel weights.

#### Tire replacement

If the tire is worn evenly, a tread wear indicator (A) will appear as a solid band across the tread.



This shows there is less than 1/16 inches (1.6 mm) of tread left on the tire. Replace the tire when this happens.

Do not wait for the band to appear across the entire tread before replacing the tire.

The Anti-lock Brake System (ABS) works by comparing the speed of the wheels. The tire size affects wheel speed. When replacing tires, all 4 tires must

use the same size originally supplied with the vehicle. Using tires of a different size can cause the ABS and Electronic Stability Control (ESC) to work irregularly.

It is best to replace all four tires at the same time. If that is not possible, or necessary, then replace the two front or two rear tires as a pair. Replacing just one tire can seriously affect your vehicle's handling.

### \* NOTICE

We recommend that when replacing tires, use the same originally supplied with the vehicles. If not, that affects driving performance.

#### Compact spare tire replacement

A compact spare tire has a shorter tread life than a regular size tire.

Replace it when you can see the tread wear indicator bars on the tire. The replacement compact spare tire should be the same size and design tire as the one provided with your new vehicle and should be mounted on the same compact spare tire wheel. The compact spare tire is not designed to be mounted on a regular size wheel, and the compact spare tire wheel is not



designed for mounting a regular size tire.

### Wheel replacement

When replacing the metal wheels for any reason, make sure the new wheels are equivalent to the original factory units in diameter, rim width and offset.

A wheel with an incorrect size may adversely affect many things: wheel and bearing life, braking and stopping abilities, handling characteristics, ground clearance, body-to-tire clearance, snow chain clearance, speedometer and odometer calibration, headlight aiming and bumper height.

### CAUTION

#### Wheels

Wheels that do not meet Kia specifications may fit poorly and result in damage to the vehicle or unusual handling and poor vehicle control.

### Tire traction

Tire traction can be reduced if you drive on worn tires, tires that are improperly inflated or on slippery road surfaces.

Tires should be replaced when tread wear indicators appear. Slow down whenever there is rain, snow or ice on the road to

reduce the possibility of losing control of the vehicle.

### Tire maintenance

In addition to proper inflation, correct wheel alignment helps to decrease tire wear.

If you find a tire is worn unevenly, have your dealer check the wheel alignment.

Make sure the newly installed tires are balanced correctly to increase vehicle ride comfort and tire life. In addition, always rebalance the tire when the tire is removed from the wheel.

### Tire sidewall labeling

This information identifies and describes the fundamental characteristics of the tire and also provides the Tire Identification Number (TIN) for safety standard certification.

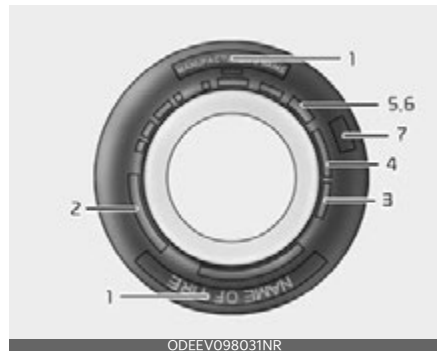

The TIN can be used to identify the tire in case of a recall.

## 1. Manufacturer or brand name

Manufacturer or Brand name is shown.

## 2. Tire size designation

A tire's sidewall is marked with a tire size designation. You will need this information when selecting replacement tires for your vehicle. The following explains what the letters and numbers in the tire size designation mean.

Example tire size designation: (These numbers are provided as an example only; your tire size designator could vary depending on your vehicle.)

### **P235/45R18 108T**

- P: Applicable vehicle type (tires marked with the prefix "P" are intended for use on passenger vehicles or light trucks; however, not all tires have this marking).
- 235: Tire width in millimeters.
- 45: Aspect ratio. The tire's section height as a percentage of its width.
- R: Tire construction code (Radial).
- 18: Rim diameter in inches.
- 108: Load Index, a numerical code associated with the maximum load the tire can carry.

- T: Speed Rating Symbol. See the speed rating chart in this section for additional information.

## Wheel size designation

Wheels are also marked with important information that you need if you ever have to replace one. The following explains what the letters and numbers in the wheel size designation mean.

Example wheel size designation:

### **7.5JX18**

- 7.5: Rim width in inches.
- J: Rim contour designation.
- 18: Rim diameter in inches.

## Tire speed ratings

The chart below lists many of the different speed ratings currently being used for passenger vehicle tires. The speed rating is part of the tire size designation on the sidewall of the tire. This symbol corresponds to that tire's designed maximum safe operating speed.

Speed Rating Symbol	Maximum Speed
S	112 mph (180 km/h)
T	118 mph (190 km/h)
H	130 mph (210 km/h)
V	149 mph (240 km/h)
W	168 mph (270 km/h)

Speed Rating Symbol	Maximum Speed
Y	186 mph (300 km/h)

### 3. Checking tire life

Any tires that are over 6 years old, based on the manufacturing date, should be replaced by new ones. You can find the manufacturing date on the tire sidewall (possibly on the inside of the wheel), displaying the DOT code. The DOT code is a series of numbers on a tire consisting of numbers and English letters. The manufacturing date is designated by the last four digits (characters) of the DOT code.

#### DOT: XXXX XXXX OOOO

The front part of the DOT means a plant code number, tire size and tread pattern and the last four numbers indicate week and year manufactured.

For example:

DOT XXXX XXXX 1623 represents that the tire was produced in the 16th week of 2023.

### **WARNING**

#### Tire age

Replace tires within the recommended time frame. Failure to replace tires as recommended can result in sudden tire failure, which could lead to a loss of control and an accident.

### 4. Tire ply composition and material

The number of layers or plies of rubber-coated fabric in the tire. Tire manufacturers also must indicate the materials in the tire, which include steel, nylon, polyester, and others. The letter "R" means radial ply construction; the letter "D" means diagonal or bias ply construction; and the letter "B" means belted-bias ply construction.

### 5. Maximum permissible inflation pressure

This number is the greatest amount of air pressure that should be put in the tire. Do not exceed the maximum permissible inflation pressure. Refer to "Tire and loading information label" on page 5-62 for recommended inflation pressure.

### 6. Maximum load rating

This number indicates the maximum load in kilograms and pounds that can be carried by the tire. When replacing the tires on the vehicle, always use a tire that has the same load rating as the factory installed tire.

## 7. Uniform tire quality grading

Quality grades can be found where applicable on the tire sidewall between tread shoulder and maximum section width.

For example:

- Treadwear 200
- Traction AA
- Temperature A

Tires degrade over time, even when they are not being used. Regardless of the remaining tread, we recommend that tires be replaced after approximately six (6) years of normal service. Heat caused by hot climate or frequent high loading conditions can accelerate the aging process.

### Tread wear

The tread wear grade is a comparative rating based on the wear rate of the tire when tested under controlled conditions on a specified government test course. For example, a tire graded 150 would wear one-and-a-half times (1½) as well on the government course as a tire graded 100.

The relative performance of tires depends upon the actual conditions of their use. Performance may depart significantly from the norm due to variations in driving habits, service practices and dif-

ferences in road characteristics and climate.

These grades are molded on the side-walls of passenger vehicle tires. The tires available as standard or optional equipment on your vehicle may vary with respect to grade.

### Traction - AA, A, B & C

The traction grades, from highest to lowest, are AA, A, B and C.

Those grades represent the tire's ability to stop on wet pavement as measured under controlled conditions on specified government test surfaces of asphalt and concrete. A tire marked C may have poor traction performance.

The traction grade assigned to this tire is based on straight-ahead braking traction tests, and does not include acceleration, cornering, hydroplaning, or peak traction characteristics.

### Temperature -A, B & C

The temperature grades are A (the highest), B and C representing the tire's resistance to the generation of heat and its ability to dissipate heat when tested under controlled conditions on a specified indoor laboratory test wheel.

Sustained high temperature can cause the material of the tire to

degenerate and reduce tire life, and excessive temperature can lead to sudden tire failure. The grade C corresponds to a level of performance which all passenger vehicle tires must meet under the Federal Motor Vehicle Safety Standard No. 109. Grades B and A represent higher levels of performance on the laboratory test wheel than the minimum required by law.

### **Tire terminology and definitions**

Refer to the following for detailed definitions of the terms that are found in the tire description.

**Air Pressure** The amount of air inside the tire pressing outward on the tire. Air pressure is expressed in pounds per square inch (psi) or kilopascal (kPa).

**Accessory Weight** The combined weight of optional accessories. Some examples of optional accessories are automatic transmission, power seats, and air conditioning.

**Aspect Ratio** The relationship of a tire's height to its width.

**Belt** A rubber coated layer of cords that is located between the plies and the tread. Cords may be made from steel or other reinforcing materials.

**Bead** The tire bead contains steel wires wrapped by steel cords that hold the tire onto the rim.

**Bias Ply Tire** A pneumatic tire in which the plies are laid at alternate angles less than 90 degrees to the centerline of the tread.

**Cold Tire Pressure** The amount of air pressure in a tire, measured in pounds per square inch (psi) or kilopascals (kPa) before a tire has built up heat from driving.

**Curb Weight** The weight of a motor vehicle with standard and optional equipment (including the maximum capacity of fuel, oil and coolant), but without passengers and cargo.

**DOT Markings** A code molded into the sidewall of a tire signifying that the tire is in compliance with the U.S. Department of Transportation motor vehicle safety standards. The DOT code includes the Tire Identification Number (TIN), an alphanumeric designator which can also identify the tire manufacturer, production plant, brand and date of production.

**GVWR** Gross Vehicle Weight Rating

**GAWR FRT** Gross Axle Weight Rating for the Front axle.

**GAWR RR** Gross Axle Weight Rating for the Rear axle.

**Intended Outboard Sidewall**

The side of an asymmetrical tire that must always face outward when mounted on a vehicle.

**Kilopascal (kPa)** The metric unit for air pressure.

**Light truck (LT) tire** A tire designated by its manufacturer as primarily intended for use on lightweight trucks or multipurpose passenger vehicles.

**Load ratings** The maximum load that a tire is rated to carry for a given inflation pressure.

**Load Index** An assigned number ranging from 1 to 279 that corresponds to the load carrying capacity of a tire.

**Maximum Inflation Pressure**

The maximum air pressure to which a cold tire may be inflated. The maximum air pressure is molded onto the sidewall.

**Maximum Load Rating** The load rating for a tire at the maximum permissible inflation pressure for that tire.

**Maximum Loaded Vehicle**

**Weight** The sum of curb weight; accessory weight; vehicle capacity weight; and production options weight.

**Normal Occupant Weight** The number of occupants a vehicle is designed to seat multiplied by 150 lbs. (68 kg).

**Occupant Distribution** Designated seating positions.

**Outward Facing Sidewall** The side of a asymmetrical tire that has a particular side that faces outward when mounted on a vehicle. The outward facing sidewall bears white lettering or bears manufacturer, brand, and/or model name molding that is higher or deeper than the same moldings on the inner facing sidewall.

**Passenger (P-Metric) Tire** A tire used on passenger cars and some light duty trucks and multipurpose vehicles.

**Ply** A layer of rubber-coated parallel cords.

**Pneumatic tire** A mechanical device made of rubber, chemicals, fabric and steel or other materials, that, when mounted on an automotive wheel, provides the traction and contains the gas or fluid that sustains the load.

**Production options weight** The combined weight of installed regular production options weighing over 5 lbs. (2.3 kg) in excess of the standard items which they replace, not previously considered in curb weight or accessory weight. Examples include heavy duty brakes, ride

levelers, roof rack, heavy duty battery, and special trim.

**Recommended Inflation Pressure** Vehicle manufacturer's recommended tire inflation pressure and shown on the tire placard.

**Radial Ply Tire** A pneumatic tire in which the ply cords that extend to the beads are laid at 90 degrees to the centerline of the tread.

**Rim** A metal support for a tire and upon which the tire beads are seated.

**Sidewall** The portion of a tire between the tread and the bead.

**Speed Rating** An alphanumeric code assigned to a tire indicating the maximum speed at which a tire can operate.

**Traction** The friction between the tire and the road surface. The amount of grip provided.

**Tread** The portion of a tire that comes into contact with the road.

**Treadwear Indicators** Narrow bands, sometimes called "wear bars," that show across the tread of a tire when only 2/32 inch (1.6 mm) of tread remains.

**UTQGS** Uniform Tire Quality Grading Standards, a tire information system that provides consumers with ratings for a tire's traction, temperature and treadwear. Ratings are deter-

mined by tire manufacturers using government testing procedures. The ratings are molded into the sidewall of the tire.

**Vehicle Capacity Weight** The weight of designated seating positions multiplied by 150 lbs. (68 kg) plus the rated cargo and luggage load.

**Vehicle Maximum Load on the Tire** Load on an individual tire due to curb and accessory weight plus maximum occupant and cargo weight.

**Vehicle Normal Load on the Tire** Load on an individual tire that is determined by distributing to each axle its share of the curb weight, accessory weight, and normal occupant weight and driving by 2.

**Vehicle Placard** A label permanently attached to a vehicle showing the original equipment tire size and recommended inflation pressure.

### All season tires

Kia specifies all season tires on some models to provide good performance for use all year round, including snowy and icy road conditions.

All season tires are identified by ALL SEASON and/or M+S (Mud and Snow) on the tire sidewall. Snow tires have better snow trac-

tion than all season tires and may be more appropriate in some areas.

### Summer tires

Kia specifies summer tires on some models to provide superior performance on dry roads.

Summer tire performance is substantially reduced in snow and ice. Summer tires do not have the tire traction rating M+S (Mud and Snow) on the tire side wall. If you plan to operate your vehicle in snowy or icy conditions, Kia recommends the use of snow tires or all season tires on all four wheels.

### Snow tires

If you equip your vehicle with snow tires, they should be the same size and have the same load capacity as the original tires. Snow tires should be installed on all four wheels; otherwise, poor handling may result.

Snow tires should carry 4 psi (28 kPa) more air pressure than the pressure recommended for the standard tires on the tire label on the driver's side of the center pillar, or up to the maximum pressure shown on the tire sidewall, whichever is less.

Do not drive faster than 75 mph (120 km/h) when your vehicle is equipped with snow tires.

### WARNING

Do not use summer tires at temperatures below 45 °F (7 °C) or when driving on snow or ice. At temperatures below 45 °F (7 °C), summer tires can lose elasticity, and therefore traction and braking power as well. Change the tires on your vehicle to winter or all-weather tires of the same size as the standard tires of the vehicle. Both types of tires are identified by the M+S (Mud and Snow) marking. Using summer tires at very cold temperatures could cause cracks to form, thereby damaging the tires permanently.

### Tire chains

Tire chains, if necessary, should be installed on the front wheels. Be sure that the chains are installed in accordance with the manufacturer's instructions.

To minimize tire and chain wear, do not continue to use tire chains when they are no longer needed.

- When driving on roads covered with snow or ice, drive at speeds less than 20 mph (30 km/h).
- Use the SAE "S" class or wire chains.
- If you hear noise caused by chains contacting the body,



retighten the chain to avoid contact with the vehicle body.

- To prevent body damage, retighten the chains after driving 0.3~0.6 miles (0.5~1.0 km).
- Do not use tire chains on vehicles equipped with aluminum wheels. In unavoidable circumstances use a wire type chain.
- Use wire chains less than 0.47 inches (12 mm) to prevent damage to the chain's connection.

### Radial-ply tires

Radial-ply tires provide improved tread life, road hazard resistance and smoother high speed ride.

The radial-ply tires used on this vehicle are of belted construction, and are selected to complement the ride and handling characteristics of your vehicle. Radial-ply tires have the same load carrying capacity, as bias-ply or bias belted tires of the same size, and use the same recommended inflation pressure.

Mixing of radial-ply tires with bias-ply or bias belted tires is not recommended. Any combinations of radial-ply and bias-ply or bias belted tires when used on the same vehicle will seriously deteriorate vehicle handling. The best rule to follow is: Identical

radial-ply tires should always be used as a set of four.

Longer wearing tires can be more susceptible to irregular tread wear. It is very important to follow the tire rotation interval shown in this section to achieve the tread life potential of these tires. Cuts and punctures in radial-ply tires are repairable only in the tread area, because of sidewall flexing. Consult your tire dealer for radial-ply tire repairs.

### Low aspect ratio tire (if equipped)

Low aspect ratio tires, whose aspect ratio is lower than 50, are provided for sporty looks.

Because the low aspect ratio tires are optimized for handling and braking, it may be more uncomfortable to ride in and there is more noise compare with normal tires.

#### CAUTION

Because the sidewall of the low aspect ratio tire is shorter than normal, the wheel and tire of the low aspect ratio tire is more easily damaged. So, follow the instructions below.

- When driving on a rough road or off road, drive cautiously because tires and wheels may be damaged. And after driving, inspect tires and wheels.

- When passing over a pothole, speed bump, manhole, or curb stone, drive slowly so that the tires and wheels are not damaged.
- If the tire is impacted, we recommend that you inspect the tire condition or contact an authorized Kia dealer.
- To prevent damage to the tire, inspect the tire condition and pressure every 1,900 miles (3,000 km).

- 
- It is not easy to recognize the tire damage with your own eyes. But if there is the slightest hint of tire damage, even though you cannot see the tire damage with your own eyes, have the tire checked or replaced because the tire damage may cause air leakage from the tire.
  - If the tire is damaged by driving on a rough road, off road, pothole, manhole, or curb stone, it will not be covered by the warranty.
  - You can find out the tire information on the tire sidewall.

## Fuses

A vehicle's electrical system is protected from electrical overload damage by fuses.

Blade type



Cartridge type



Multi fuse



BFT



\* Left side: Normal, Right side: Blown

This vehicle has 2 (or 3) fuse panels, one located in the driver's side panel bolster, the other in the engine compartment near the battery.

If any of your vehicle's lights, accessories, or controls do not work, check the appropriate circuit fuse. If a fuse has blown, the element inside the fuse will melt.

If the electrical system does not work, first check the driver's side fuse panel.

If the replacement fuse blows, this indicates an electrical problem. Avoid using the system involved and immediately consult an authorized Kia dealer.

Three kinds of fuses are used: blade type for lower amperage rating, cartridge type, and multi fuse for higher amperage ratings.

### **⚠ WARNING**

#### **Fuse replacement**

- Never replace a fuse with anything but another fuse of the same rating.
- A higher capacity fuse could cause damage and possibly a fire.
- Never install a wire or aluminum foil instead of the proper fuse - even as a temporary repair. It may cause extensive wiring damage and a possible fire.
- Do not arbitrarily modify or add-on electric wiring to the vehicle.

### **⚠ CAUTION**

Do not use a screwdriver or any other metal object to remove fuses because it may cause a short circuit and damage the system.

### **\* NOTICE**

- When replacing a fuse, turn the ignition 'OFF' and turn off switches of all electrical devices then remove battery (-) terminal.

- The actual fuse/relay panel label may differ from equipped items.

### **⚠ WARNING**

#### **Electrical Fire**

Always ensure replacements fuses and relays are securely fastened when installed. Failure to do so can result in a vehicle fire.

Do not remove fuses, relays and terminals fastened with bolts or nuts. The fuses, relays and terminals may be fastened incompletely, and it may cause a possible fire. If fuses, relays and terminals fastened with bolts or nuts are blown, consult with an authorized Kia dealer.

### **⚠ CAUTION**

When replacing a blown fuse or relay, make sure the new fuse or relay fits tightly into the clips. Failure to tightly install the fuse or relay may cause damage to the wiring and electric systems.

### **⚠ CAUTION**

- Do not input any other objects except fuses or relays into fuse/relay terminals such as a screwdriver or wiring. It may cause contact failure and system malfunction.
- Do not plug in screwdrivers or after-market wiring into the terminal originally designed for fuse and relays only. The electrical system and wiring of the vehicle interior may be damaged or burned due to contact failure.
- If you directly connect the wire on the taillight or replace the bulb which is over the regulated capacity to install

trailers etc., the inner junction block can get burned.

### **⚠ WARNING**

#### **Electrical wiring repairs**

All electrical repairs should be performed by authorized Kia dealerships using approved Kia parts. Using other wiring components, especially when retrofitting multimedia or theft alarm system, car phone or radio may cause vehicle damage and increase the risk of a vehicle fire.

### **\* NOTICE**

#### **Remodeling Prohibited**

Do not rewire your vehicle in any way as doing so may affect the performance of several safety features in your vehicle. Rewiring your vehicle may also void your warranty and cause you to be responsible for any subsequent vehicle damage which may result.

#### **Replacing inner panel fuse**

1. Turn the ENGINE START/STOP button and all other switches off.
2. Open the fuse panel cover.



3. Pull the suspected fuse straight out. Use the removal tool provided on the engine fuse panel cover.

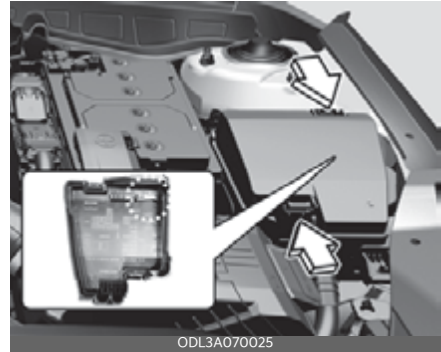

4. Check the removed fuse; replace it if it is blown.

Spare fuses are provided in the engine compartment fuse panel.

5. Push in a new fuse of the same rating, and make sure it fits tightly in the clips.

If it fits loosely, consult an authorized Kia dealer.

If you do not have a spare, use a fuse of the same rating from a circuit you may not need for operating the vehicle, such as the power outlet fuse.

If the head lamp, turn signal lamp, stop signal lamp, fog lamp, DRL, tail lamp, High Mounted Stop Lamp (HMSL) do not work and the fuses are OK, check the fuse panel in the engine compartment. If a fuse is blown, it must be replaced.

### **\* NOTICE**

If the headlamp, fog lamp, turn signal lamp, or tail lamp malfunction even without any problem to the lamps, have the vehicle checked by an authorized Kia dealer for assistance.

## Replacing engine compartment fuse

1. Turn the ENGINE START/STOP button and all other switches off.
2. Remove the fuse panel cover by pressing the tab and pulling the cover up.



3. Check the removed fuse; replace it if it is blown. To remove or insert the fuse, use the fuse puller in the engine compartment fuse panel.
4. Push in a new fuse of the same rating, and make sure it fits tightly in the clips. If it fits loosely, consult an authorized Kia dealer.

### **⚠ CAUTION**

Always securely install the fuse panel cover in the engine compartment to protect against electrical failure which may occur from water contact. Listen for the audible clicking sound to ensure fuse panel cover is securely fastened.

### **\* NOTICE**

If the main (multi) fuse is blown, have the vehicle checked by an authorized Kia dealer.

### **\* NOTICE**

The electronic system may not function correctly even when the engine compartment and internal fuse box's individual fuses are not disconnected. In such cases, the cause of the problem may be disconnection of the main fuse (BFT type), which is located inside the positive battery terminal (+) cap. Since the main fuse is designed more intricately than other parts, have the vehicle checked by an authorized Kia dealer.

After checking the fuse panel in the engine compartment, securely install the fuse panel cover through the audible clicking sound. If not, electrical failures may occur from water contact.

## Main fuse (Multi fuse)

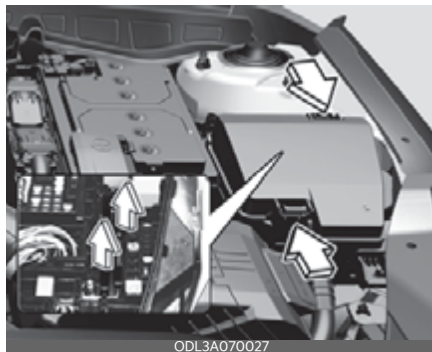

If the multi fuse is blown, it must be removed as follows:

1. Turn the ENGINE START/STOP button and all other switches off.
2. Disconnect the negative battery cable.
3. Remove the nuts shown in the picture above.
4. Replace the fuse with a new one of the same rating.
5. Reverse these steps to reinstall the multi fuse.

**\* NOTICE**

Do not disassemble nor assemble the multi fuse when it is secured with nuts and bolts. Incorrect or partial assembly torque may cause a fire. Have the vehicle checked by an authorized Kia dealer.

**Battery fuse**

If the battery fuse is blown, it must be removed as follows:

1. Disconnect the negative battery cable.
2. Remove the nuts shown in the picture below.



3. Replace the fuse with a new one of the same rating.
4. Reinstall in the reverse order of removal.

**\* NOTICE**

If the battery fuse is blown, have the vehicle checked by an authorized Kia dealer.

**⚠ CAUTION**

Visually inspect the battery cap to ensure it is securely closed. If the battery cap is not securely closed, moisture may enter the system and damage the electrical components.

**Fuse/relay panel description**

Inside the fuse/relay panel covers, you can find the fuse/relay label describing fuse/relay name and capacity.

**Driver's side fuse panel****\* NOTICE**

Not all fuse panel descriptions in this manual may be applicable to your vehicle. It is accurate at the time of printing. When you inspect the fuse panel in your vehicle, refer to the fuse panel label on the inside of the fuse cover. This diagram will provide you with the specific information for your vehicles.

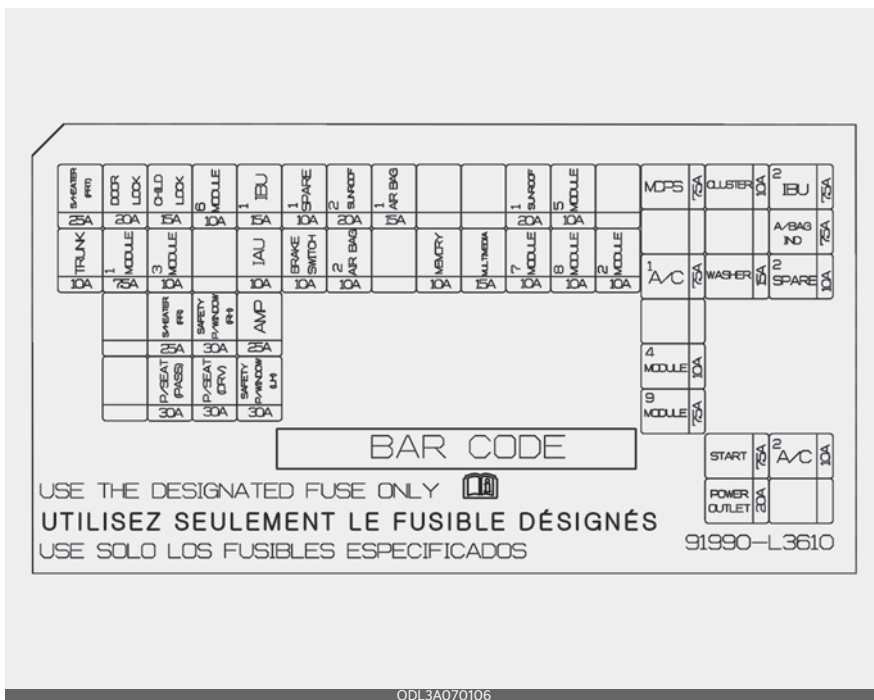

Refer to the following table for a description of the fuse.

Fuse Name	Fuse rating	Circuit Protected
S/HEATER (FRT)	25A	Front Seat Warmer Control Module, Front Air Ventilation Seat Control Module
TRUNK	10A	Trunk Lid Relay
DOOR LOCK	20A	Door Lock Relay, Door Unlock Relay, Two Turn Unlock Relay
MODULE1	7.5A	Front Console Switch #1, Key Solenoid, Driver/Passenger Smart Key Outside Handle
CHILD LOCK	15A	Rear Child Lock Relay, Rear Child Unlock Relay
MODULE3	10A	Hazard Switch, Front Mood Lamp Right Handle side, Front Mood Lamp Unit, Driver Door Module, Driver/Passenger Door Mood Lamp
S/HEATER (RR)	25A	Rear Seat Warmer Control Module
P/SEAT (PASS)	30A	Passenger Seat Manual Switch
MODULE6	10A	Sport Mode Switch, Driver Door Module
SAFETY P/WINDOW (RH)	30A	Passenger Power Window Switch, Passenger Safety Power Window Module, Rear Power Window Switch Right Handle side, Rear Safety Power Window Module Right Handle side
P/SEAT (DRV)	30A	Driver Seat Manual Switch, Driver IMS (Integrated memory system) Module
IBU1	15A	Ignition Switch, IBU (Integrated Body Control Unit)
AMP	25A	DC-DC Converter (AMP (Amplifier)), AMP (Amplifier)
SAFETY P/WINDOW (LH)	30A	Driver Safety Power Window Module, Rear Power Window Switch Left Handle side, Rear Safety Power Window Module Left Handle side
SPARE1	15A	Not Used

Fuse Name	Fuse rating	Circuit Protected
BRAKE SWITCH	10A	IBU (Integrated Body Control Unit), Stop Lamp Switch
SUNROOF2	20A	Sunroof Controller (Blind Motor), Data Link Connector
AIR BAG2	10A	SRS (Supplemental Restraint System) Control Module
AIR BAG1	15A	SRS (Supplemental Restraint System) Control Module
MEMORY	10A	Head-up Display, Driver IMS (Integrated memory system) Module, Driver/Passenger Power Outside Mirror, Rain Sensor, Instrument Cluster, Air Conditioner Control Module, Air Conditioner Switch
MULTI MEDIA	15A	DC-DC Converter (Audio), Audio, Audio/Video & Navigation Head Unit
SUNROOF1	20A	Sunroof Controller (Glass Motor)
MODULE7	10A	4WD (4 Wheel Drive) ECU (Engine Control Unit), Front Console Switch #1/#2, Front View Camera, IBU (Integrated Body Control Unit), Crash Pad Switch, ADAS Parking ECU, EPB Switch, Vacuum Switch
MDOULE5	10A	Stop Lamp Switch
MODULE8	10A	AMP (Amplifier), Driver IMS (Integrated memory system) Module, Front Wireless Charger, Front Air Ventilation Seat Control Module, Front/Rear Seat Warmer Control Module, ATM (Automatic Transmission) Shift Lever Indicator, Data Link Connector, Audio, Audio/Video & Navigation Head Unit, Air Conditioner Switch, Surround View Monitor Unit, Air Conditioner Control Module, DC-DC Converter (Audio/AMP (Amplifier)), Electro Chromic Mirror
MODULE2	10A	Cooling Fan Motor, ADAS Parking ECU, Front/Rear Seat Warmer Control Module, Front Air Ventilation Seat Control Module, Engine Room Junction Block (W/S Heated Glass Left Handle side/Right Handle side Relay)
MDPS	7.5A	MDPS (Motor Driven Power Steering) Unit (Column Type, Rack Type)
A/C1	7.5A	Air Conditioner Control Module, Air Conditioner Switch, Engine Room Junction Block (Blower Relay)
MODULE4	10A	Rear USB Charger, PCB Block (Power Outlet Relay), Console USB Charger (Outside Rear Left Handle side/Right Handle side), Console USB Charger (Inside), AMP (Amplifier), IBU (Integrated Body Control Unit), DC-DC Converter (Audio/AMP (Amplifier)), Audio, Audio/Video & Navigation Head Unit, Surround View Monitor Unit, ADAS Parking ECU
MODULE9	7.5A	IBU (Integrated Body Control Unit)
CLUSTER	10A	Instrument Cluster, Head-up Display
WASHER	15A	Multifunction Switch
START	7.5A	B/Alarm Relay, IBU (Integrated Body Control Unit), ECM (Engine Control Module), Transmission Range Switch, Engine Room Junction Block (Start Relay)
POWER OUTLET	20A	Not Used
IBU2	7.5A	IBU (Integrated Body Control Unit)
A/BAG IND	7.5A	Instrument Cluster, Overhead Console Lamp
SPARE2	10A	Not Used
A/C2	10A	Air Conditioner Control Module



### Engine compartment fuse panel

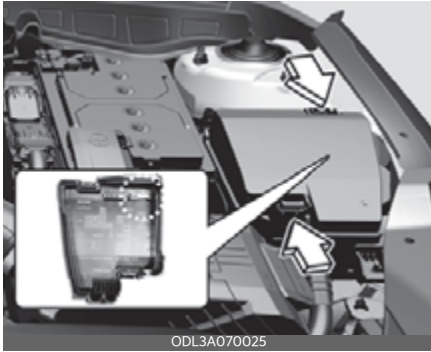

Smartstream G1.6 T-GDI

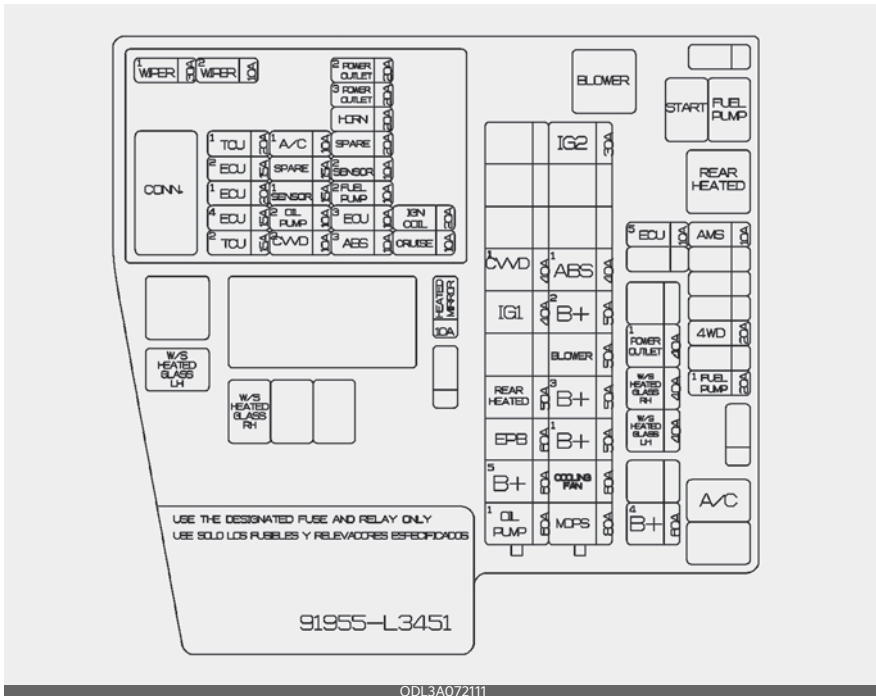



Fuse Name	Fuse rating	Circuit Protected
MULTI FUSE-2	CVD1	40A [Smartstream G 1.6 T-GDi] CVVD Actuator
	E-CVVT1	40A [Smartstream G 2.5 T-GDi] Engine Room Junction Block (E-CVVT Relay)
	IG1	40A PCB Block (Ignition switch1 Relay, ACC Relay)
	REAR HEATED	50A Engine Room Junction Block (Rear Heated Relay)
	EPB	60A ESC (Electronic Stability Control) Module
	B+5	60A PCB Block (Engine Control Relay, Fuse - Air Conditioner1, WIPER1, TCU (Transmission Control Unit)1, HORN, ECU (Engine Control Unit)2)
	OIL PUMP1	60A [Smartstream G 1.6 T-GDi] Electronic Oil Pump
	OIL PUMP	60A [Smartstream G 2.5 T-GDi] Electronic Oil Pump

Fuse Name	Fuse rating	Circuit Protected
FUSE	POWER OUTLET1	40A PCB Block (Power Outlet Relay)
	W/S HEATED GLASS RH	40A W/S Heated Glass Right Handle side Relay
	W/S HEATED GLASS LH	40A W/S Heated Glass Left Handle side Relay
	TCU3	60A [Smartstream G 2.5 T-GDi] TCM (Transmission Control Module)
	B+4	60A ICU Junction Block (Long Term Load Latch Relay, Fuse - MOD <sup>+</sup> ULE3, AIR BAG2, SUNROOF1, SUNROOF2, S/HEATER (FRT), TRUNK, BRAKE SWITCH, DOOR LOCK)
	ECU5	10A [Smartstream G 1.6 T-GDi] ECM (Engine Control Module)
	AMS	10A Battery Sensor
	VACUUM PUMP1	20A [Smartstream G 2.5 T-GDi] Vacuum Relay
	4WD	20A [Smartstream G 1.6 T-GDi] 4WD (4 Wheel Drive) ECU (Engine Control Unit)
	FUEL PUMP1	20A Engine Room Junction Block (Fuel Pump Relay)
	VACUUM PUMP2	10A [Smartstream G 2.5 T-GDi] ESC (Electronic Stability Control) Module
	E-CVVT3	20A [Smartstream G 2.5 T-GDi] ECM (Engine Control Module)
	HEATED MIRROR	10A Air Conditioner Switch
E-CVVT4	20A [Smartstream G 2.5 T-GDi] ECM (Engine Control Module)	

PCB Block: Smartstream G1.6 T-GDi

Fuse Name	Fuse rating	Circuit Protected
WIPER1	30A	PCB Block (Wiper Relay)
WIPER2	10A	IBU (Integrated Body Control Unit), ECM (Engine Control Module)
TCU1	20A	TCM (Transmission Control Module)
ECU2	15A	ECM (Engine Control Module)
ECU1	20A	ECM (Engine Control Module)
ECU4	15A	ECM (Engine Control Module)
TCU2	15A	TCM (Transmission Control Module), Transmission Range Switch
A/C1	10A	Engine Room Junction Block (Air Conditioner Relay)

Fuse Name	Fuse rating	Circuit Protected
SENSOR1	15A	Oxygen Sensor (Up/Down)
OIL PUMP2	10A	Electronic Oil Pump
CVVD2	10A	CVVD Actuator
POWER OUTLET2	20A	Front Power Outlet Left Handle side
POWER OUTLET3	20A	Front USB Charger
HORN	20A	PCB Block (Horn Relay)
SENSOR2	10A	Oil Control Valve (Intake/Exhaust), Variable Oil Pump Solenoid Valve, Purge Control Solenoid Valve, RCV (Recirculation Valve Control) Control Solenoid Valve, Canister Close Valve, Engine Room Junction Block (Air Conditioner Relay)
FUEL PUMP2	10A	Engine Room Junction Block (Fuel Pump Relay)
ECU3	10A	ECM (Engine Control Module)
ABS3	10A	ESC (Electronic Stability Control) Module
IGN COIL	20A	Ignition Coil #1 ~ #4
CRUISE	10A	Front Radar

## PCB Block: Smartstream G2.5 T-GDi

Fuse Name	Fuse rating	Circuit Protected
WIPER1	30A	PCB Block (Wiper Relay)
WIPER2	10A	IBU (Integrated Body Control Unit), ECM (Engine Control Module)
TCU1	20A	Not Used
ECU2	15A	ECM (Engine Control Module)
ECU1	20A	ECM (Engine Control Module)
ECU4	15A	ECM (Engine Control Module)
TCU2	15A	TCM (Transmission Control Module)
A/C1	10A	Engine Room Junction Block (Air Conditioner Relay)
INJECTOR	15A	Injector #1 ~ #4
SENSOR1	15A	Oxygen Sensor (Up/Down)
POWER OUTLET2	20A	Front Power Outlet Left Handle side
POWER OUTLET3	20A	Front USB Charger
HORN	20A	PCB Block (Horn Relay)
SENSOR2	10A	Oil Control Valve (Exhaust), Variable Oil Pump Solenoid Valve, Purge Control Solenoid Valve, RCV (Recirculation Valve Control) Control Solenoid Valve, Canister Close Valve, Engine Room Junction Block (Air Conditioner Relay)
FUEL PUMP2	10A	Engine Room Junction Block (Fuel Pump Relay)
ECU3	10A	ECM (Engine Control Module)
ABS3	10A	ESC (Electronic Stability Control) Module
IGN COIL	20A	Ignition Coil #1 ~ #4
CRUISE	10A	Front Radar

## Battery terminal cover

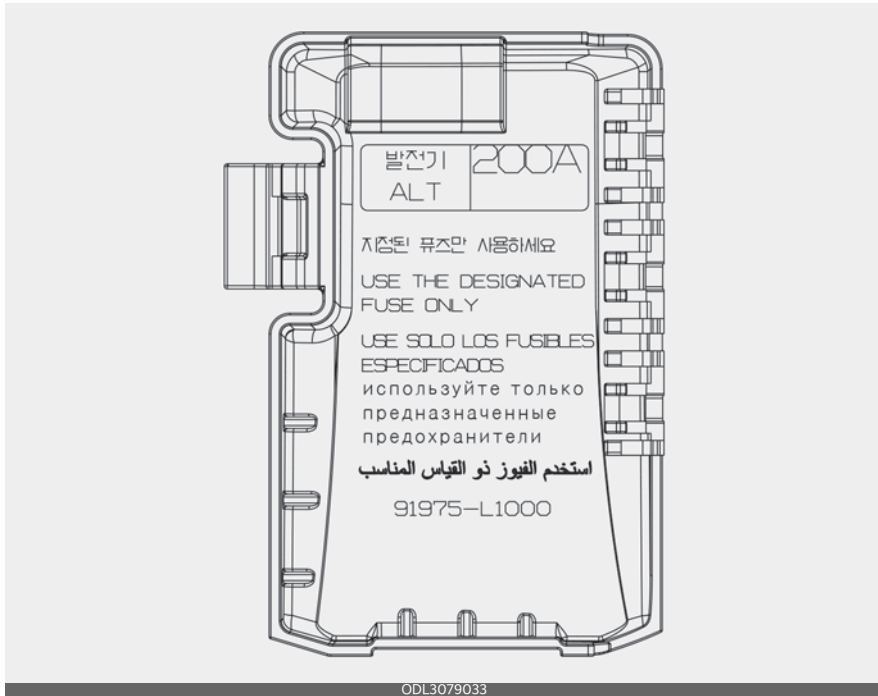

### \* NOTICE

Not all fuse panel descriptions in this manual may be applicable to your vehicle. It is accurate at the time of printing. When you inspect the fuse panel in your vehicle, refer to the fuse panel label.

## Light bulbs

Light bulbs are installed in various parts of the vehicle to provide lighting inside and outside the vehicle as well as to alert other vehicles.

### Bulb replacement precaution

Please keep extra bulbs on hand with appropriate wattage ratings in case of emergencies.

Refer to "Bulb wattage" on page 9-7.

When changing lamps, first turn off the vehicle at a safe place, firmly apply the parking brake and detach the battery's negative (-) terminal.

### ⚠ WARNING

#### Working on the lights

Prior to working on the light,

- (1) Firmly apply the parking brake
- (2) Turn the ENGINE START/STOP button to the OFF position
- (3) Turn off the lights to avoid sudden movement of the vehicle and burning your fingers or receiving an electric shock.

Use only bulbs of the specified wattage.

### ⚠ CAUTION

#### Light replacement

Be sure to replace the burned-out bulb with one of the same wattage rating. Otherwise, it may cause damage to the fuse or electric wiring system.

Fully install light bulbs and any parts used to secure them. Failure to do so may result in heat damage, fire, or water entering the headlight unit. This may damage the headlights or cause condensation to build up on the lens. To

prevent damage or fire, make sure bulbs are fully seated and locked.

### ⚠ CAUTION

#### Headlamp Lens

To prevent damage, do not clean the headlamp lens with chemical solvents or strong detergents.

### \* NOTICE

- If the light bulb or lamp connector is removed while the lamp is still on, the fuse box's electronic system may log it as a malfunction. Therefore, a lamp malfunction incident may be recorded as a Diagnostic Trouble Code (DTC) in the fuse box.
- It is normal for an operating lamp to flicker momentarily. This is due to a stabilization function of the vehicle's electronic control device. If the lamp lights up normally after momentarily blinking, then it is functioning as normal.

However, if the lamp continues to flicker several times or turns off completely, there may be an error in the vehicle's electronic control device. Please have the vehicle checked by an authorized Kia dealer immediately.

### \* NOTICE

Have the headlight aiming adjusted by an authorized Kia dealer after an accident or after the headlight assembly is reinstalled.

### \* NOTICE

You can find moisture inside the lens of lamps after a car wash or driving in the rain. It is a natural event caused by the

temperature difference between the inside and the outside of the lamp and does not mean there is a problem with its functions. The moisture inside the lamp would disappear if you drive the vehicle with the headlamp turned on. However, the level at which the moisture is removed may differ depending on the size/location/condition of the lamp. If the moisture continues to stay inside the lamp, have the vehicle checked by an authorized Kia dealer.

If you don't have the necessary tools, the correct bulbs and the expertise, consult an authorized Kia dealer. In many cases, it is difficult to replace vehicle light bulbs because other parts of the vehicle must be removed before you can get to the bulb. This is especially true if you have to remove the headlamp assembly to get to the bulb(s).

Removing/installing the headlamp assembly can result in damage to the vehicle. If non-genuine parts or standard bulbs are used, it may lead to blowing a fuse or other wiring damages.

Kia Genuine Parts we guarantee for quality and performance.

Do not install extra lamps or LEDs to the vehicle. If additional lights are installed, it may lead to lamp malfunctions and flickering. Additionally, the fuse box and other wiring may be damaged.

## Light bulb position (Front)

Headlamp - Type A

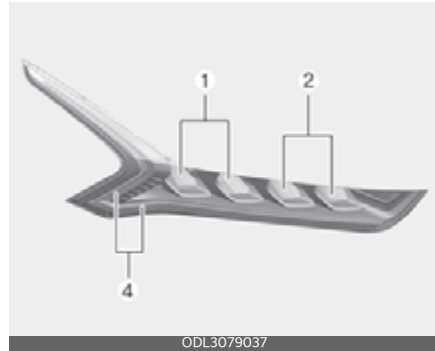

Headlamp - Type B

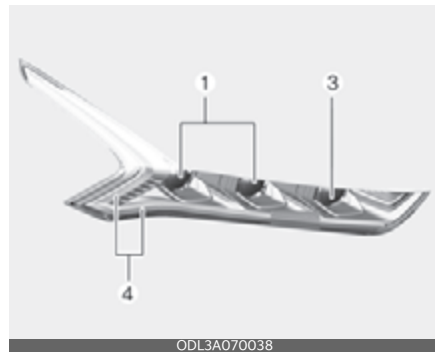

Fog lamp



- 1. Headlamp (Low) (LED type)
- 2. Headlamp (High) (LED type)

3. Headlamp (High and Auxiliary Low) (LED type)
4. Daytime running lamp / Position lamp / Turn signal lamp (LED type)
5. Front fog lamp (LED type)
6. Front side marker lamp (LED type)

### Light bulb position (Rear)

Rear combination lamp - Type A

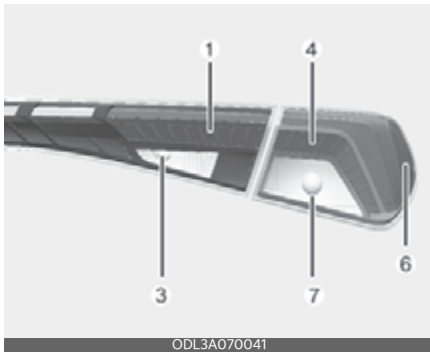

Rear combination lamp - Type B

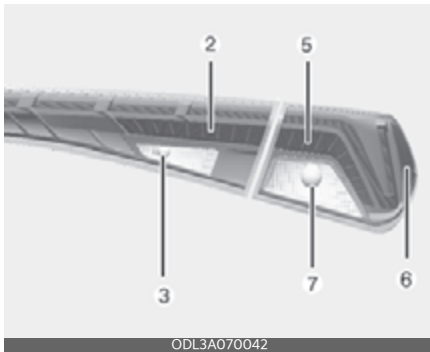

License Plate lamp

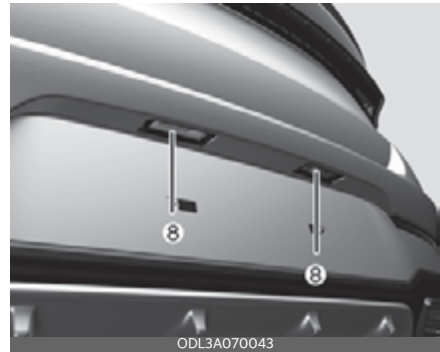

High mounted stop lamp

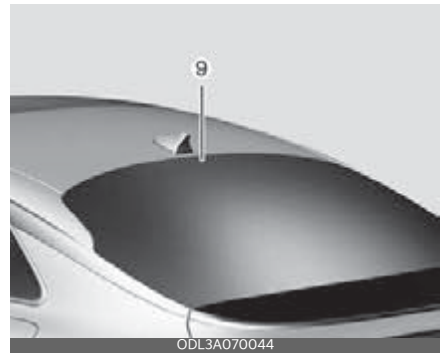

1. Tail lamp (Bulb type)
2. Tail lamp (LED type)
3. Back up lamp (Bulb type)
4. Tail lamp & stop lamp (Bulb type)
5. Tail lamp & stop lamp (LED type)
6. Rear side marker lamp (LED type)
7. Turn signal lamp (Bulb type)
8. License plate lamp (Bulb type)
9. High mounted stop lamp (LED type)



**Light bulb position (Side) (if equipped)**



- 1. Side repeater lamp (LED type)

**Replacing headlamp, position lamp/daytime running lamp bulb, turn signal lamp bulb (LED type)**

Type A



Type B



If the headlamp, position lamp/daytime running lamp, turn signal lamp LED does not operate, have the vehicle checked by an authorized Kia dealer.

**Replacing front fog lamp bulb (LED type) (if equipped)**

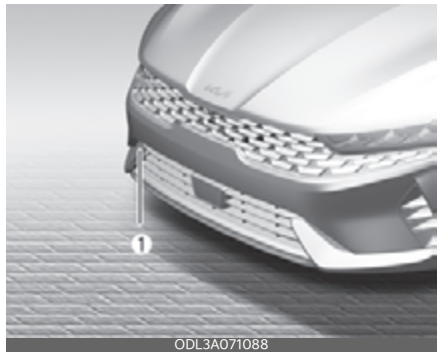

If the front fog lamp LED (1) does not operate, have the vehicle checked by an authorized Kia dealer.

### Replacing front side marker lamp bulb (LED type)



If the front side marker lamp LED (1) does not operate, have the vehicle checked by an authorized Kia dealer.

### Replacing side repeater lamp bulb (LED type) (if equipped)



If the side repeater lamp LED (1) does not operate, have the vehicle checked by an authorized Kia dealer.

### Replacing rear tail & stop lamp, stop lamp, turn signal lamp, back up lamp bulb (Bulb type)

Type A

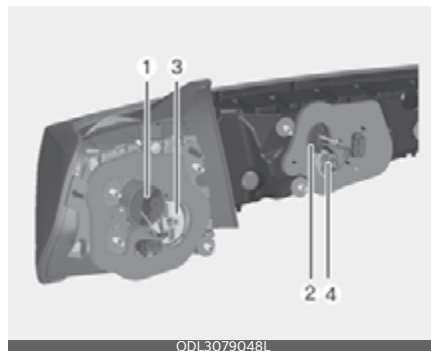

Type B

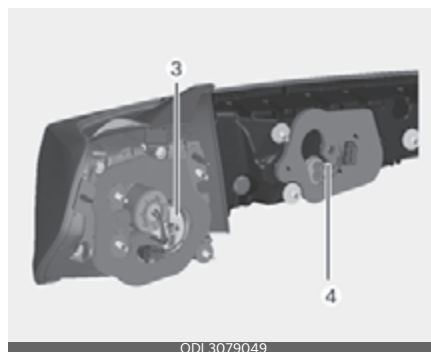

1. Tail and stop lamp
2. Tail lamp (center)
3. Turn signal lamp
4. Back up lamp

To replace the bulb:

1. Engage the parking brake, shift to P and turn the ignition OFF.
2. Turn of the rear combination lamp.
3. Open the trunk.
4. Remove the rear combination lamp assembly or rear trunk trim from the

body of vehicle using the flat-blade screwdriver.



- Remove the socket from the assembly by pressing it in and rotating it counterclockwise.

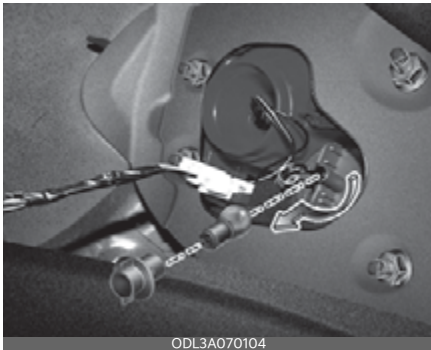

- Pull the bulb out of the socket.
- Insert a new bulb into socket.
- Push the socket into the assembly and turn the socket clockwise.
- Reinstall the assembly to the body of the vehicle.

### Replacing tail lamp, tail & stop lamp, rear side marker bulb (LED type)

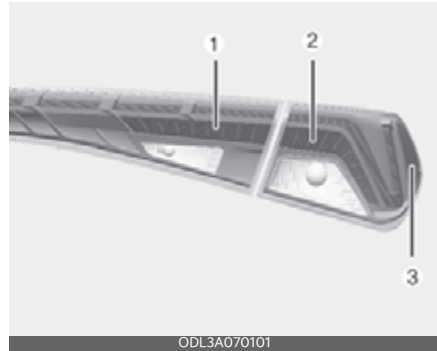

If the tail lamp (1), tail & stop lamp (2) and side marker lamp (3) does not operate, have the vehicle checked by an authorized Kia dealer.

### Replacing high mounted stop lamp bulb (LED type)

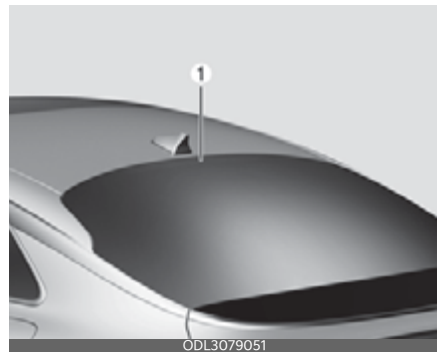

If the high mounted stop lamp (LED type) (1) does not operate, have the vehicle checked by an authorized Kia dealer.

The LED lamp cannot be replaced as a single component because it is an integrated unit. The LED lamp has to be replaced with the unit.

A skilled technician should check or repair the high mounted stop lamp (LED

type), for it may damage related parts of the vehicle.

### Replacing license plate lamp bulb (Bulb type)

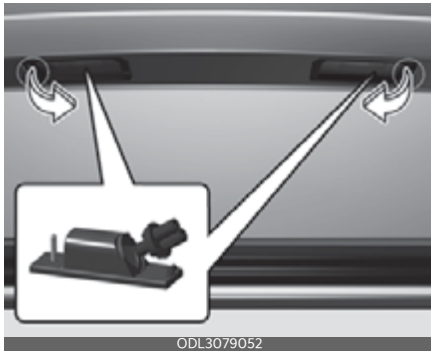

To replace the bulb:

1. Engage the parking brake, shift to P and turn the ignition OFF.
2. Turn of the lamp.
3. Using a screwdriver, gently pry the lamp assembly.
4. Remove the bulb by pulling it straight out.
5. Install a new bulb in the socket.
6. Install the lamp assembly to interior.

### Replacing map lamp bulb (Bulb/LED type) (if equipped)

Bulb type



LED type



**⚠ WARNING****Interior lamps**

Prior to working on the Interior lamps, ensure that the "OFF" button is depressed to avoid burning your fingers or receiving an electric shock.

1. Engage the parking brake, shift to P and turn the ignition OFF.
2. Turn off the lamp.
3. Using a flat-blade screwdriver, gently pry the lens cover from lamp housing.
4. Remove the bulb by pulling it straight out.
5. Install a new bulb in the socket.
6. Align the lens cover tabs with the lamp housing notches and snap the lens into place.

If the map lamp bulb/LED (1) does not operate, have the vehicle checked by an authorized Kia dealer.

The LED lamp cannot be replaced as a single unit because it is an integrated unit. The LED lamp has to be replaced with the unit.

A skilled technician should check or repair the map lamp (LED), for it may damage related parts of the vehicle.

**\* NOTICE**

Be careful not to dirty or damage the lens, lens tab, and plastic housings.

**Replacing vanity mirror lamp bulb (Bulb type) (if equipped)****⚠ WARNING****Interior lamps**

Prior to working on the Interior lamps, ensure that the "OFF" button is depressed to avoid burning your fingers or receiving an electric shock.

To replace the bulb:

1. Engage the parking brake, shift to P and turn the ignition OFF.
2. Turn of the lamp.
3. Using a flat-blade screwdriver, gently pry the lamp assembly from interior.
4. Remove the bulb by pulling it straight out.
5. Install a new bulb in the socket.
6. Install the lamp assembly to interior.

**\* NOTICE**

Be careful not to dirty or damage the lens, lens tab, and plastic housings.

## Replacing room lamp bulb (Bulb type) (if equipped)



### ⚠ WARNING

#### Interior lamps

Prior to working on the Interior lamps, ensure that the "OFF" button is depressed to avoid burning your fingers or receiving an electric shock.

1. Engage the parking brake, shift to P and turn the ignition OFF.
2. Turn off the lamp.
3. Using a flat-blade screwdriver, gently pry the lens cover from lamp housing.
4. Remove the bulb by pulling it straight out.
5. Install a new bulb in the socket.
6. Align the lens cover tabs with the lamp housing notches and snap the lens into place.

### \* NOTICE

Be careful not to dirty or damage the lens, lens tab, and plastic housings.

## Replacing room lamp bulb (LED type) (if equipped)

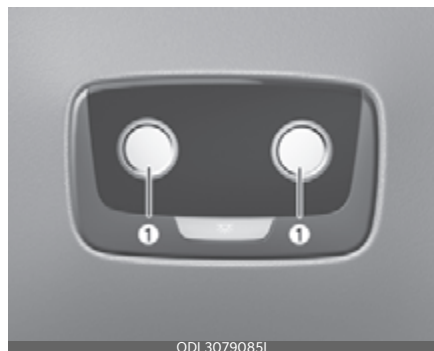

If the Room lamp (LED) (1) does not operate, have the vehicle checked by an authorized Kia dealer.

The LED lamps cannot be replaced as a single component because they are part of an integrated unit. The LED lamps have to be replaced with the unit.

A skilled technician should check or repair the Room lamp (LED), for it may damage related parts of the vehicle.

## Replacing personal lamp bulb (LED type)



If the personal lamp LED (1) does not operate, have the vehicle checked by an authorized Kia dealer.

## Replacing trunk room lamp (Bulb type)



### **⚠ WARNING**

#### Interior lamps

Prior to working on the Interior lamps, ensure that the "OFF" button is depressed to avoid burning your fingers or receiving an electric shock.

1. Engage the parking brake, shift to P and turn the ignition OFF.
2. Turn off the lamp.
3. Using a flat-blade screwdriver, gently pry the lamp assembly from interior.
4. Remove the bulb by pulling it straight out.
5. Install a new bulb in the socket.
6. Install the lamp assembly to interior.

### **⚠ CAUTION**

Be careful not to dirty or damage the lens, lens tab, and plastic housings.

## Appearance care

Use the information in the following sections to keep the exterior and interior of your vehicle clean.

### Exterior care

Use the information in the following sections to maintain the exterior of your vehicle. Keeping the exterior clean is not only aesthetically pleasing, but it also helps to prolong the life of the vehicle.

#### **\* NOTICE**

If you park the vehicle around a stainless signboard or windshield building etc., the plastic exterior trim (bumper, spoiler, garnish, lamp, outside mirror etc.) may be damaged by reflected sunlight from the external structure. To avoid damaging the plastic exterior trim, park the vehicle away from the areas where the reflected light may occur or use a vehicle cover. (Depending on the vehicle, the type of exterior trim applied such as spoiler may differ.)

### Exterior general caution

It is very important to follow the label directions when using any chemical cleaner or polish. Read all warning and caution statements that appear on the label.

### Finish maintenance

#### Washing

To help protect your vehicle's finish from rust and deterioration, wash it thoroughly and frequently at least once a month with lukewarm or cold water.

If you use your vehicle for off-road driving, you should wash it after each off-

road trip. Pay special attention to the removal of any accumulation of salt, dirt, mud, and other foreign materials. Make sure the drain holes in the lower edges of the doors and rocker panels are kept clear and clean.

Insects, tar, tree sap, bird droppings, industrial pollution and similar deposits can damage your vehicle's finish if not removed immediately.

Even prompt washing with plain water may not completely remove all these deposits. A mild soap, safe for use on painted surfaces, may be used.

After washing, rinse the vehicle thoroughly with lukewarm or cold water. Do not allow soap to dry on the finish.

After washing the vehicle, test the brakes while driving slowly to see if they have been affected by water. If braking performance is impaired, dry the brakes by applying them lightly while maintaining a slow forward speed.

### CAUTION

- Do not use strong soap, chemical detergents or hot water, and do not wash the vehicle in direct sunlight or when the body of the vehicle is warm.
- Be careful when washing the side windows of your vehicle, especially with high-pressure water. Water may leak through the windows and wet the interior.
- To prevent damage to the plastic parts and lamps, do not clean with chemical solvents or strong detergents.

### WARNING

After washing the vehicle, test the brakes while driving slowly to see if they have been affected by water. If braking performance is impaired, dry the brakes by applying them lightly while maintaining a slow forward speed.

### High-pressure washing

When using high-pressure washers, make sure to maintain sufficient distance from the vehicle.

Insufficient clearance or excessive pressure can lead to component damage or water penetration.

Do not spray the camera, sensors or its surrounding area directly with a high pressure washer. Shock applied from high pressure water may cause the device to not operate normally.

Do not bring the nozzle tip close to boots (rubber or plastic covers) or connectors as they may be damaged if they come into contact with high pressure water.

### WARNING

After washing the vehicle, test the brakes while driving slowly to see if they have been affected by water. If braking performance is impaired, dry the brakes by applying them lightly while maintaining a slow forward speed.



**⚠ CAUTION****Wetting engine compartment**

- Water washing in the engine compartment including high pressure water washing may cause the failure of electrical circuits located in the engine compartment.
- Never allow water or other liquids to come in contact with electrical/electronic components and air duct inside the vehicle as this may damage them.
- After the vehicle has been washed, brake carefully while paying attention to the traffic conditions until the braking effect has been fully restored.

**Waxing**

Wax the vehicle when water will no longer bead on the paint.

Always wash and dry the vehicle before waxing. Use a good quality liquid or paste wax, and follow the manufacturer's instructions. Wax all metal trim to protect it and to maintain its luster.

Removing oil, tar, and similar materials with a spot remover will usually strip the wax from the finish. Be sure to re-wax these areas even if the rest of the vehicle does not yet need waxing.

Be careful not to touch the lens when waxing the lamps.

**⚠ CAUTION****Drying vehicle**

- Wiping dust or dirt off the body with a dry cloth will scratch the finish.
- Do not use steel wool, abrasive cleaners, acid detergents or strong detergents containing high alkaline or caustic agents on chrome-plated or anodized aluminum parts. This may result in damage to the protective coating and cause discoloration or paint deterioration.

**Finish damage repair**

Deep scratches or stone chips in the painted surface must be repaired promptly. Exposed metal will quickly rust and may develop into a major repair expense.

**\* NOTICE**

If your vehicle is damaged and requires any metal repair or replacement, be sure the body shop applies anti-corrosion materials to the parts repaired or replaced.

**\* NOTICE****Matte paint finish vehicle**

In case of matte paint finish vehicles, it is impossible to modify only the damaged area and repair of the whole part is necessary. If the vehicle is damaged and painting is required, have your vehicle maintained and repaired by an authorized Kia dealer. Take extreme care, as it is difficult to restore the quality after the repair.

## Bright-metal maintenance

To remove road tar and insects, use a tar remover, not a scraper or other sharp object.

To protect the surfaces of bright metal parts from corrosion, apply a coating of wax or chrome preservative and rub to a high luster.

During winter weather or in coastal areas, cover the bright metal parts with a heavier coating of wax or preservative. If necessary, coat the parts with non-corrosive petroleum jelly or other protective compound.

## Underbody maintenance

Road salt and other corrosive chemicals are used in cold weather states to melt snow and prevent ice accumulation. If these chemicals are not regularly removed, they will corrode the vehicle underbody and, over time, damage many parts: the fuel lines, the fuel tank retention system, the vehicle's suspension, the exhaust system, and even the body frame.

The National Highway Traffic Safety Administration has warned all vehicle owners of all brands of the need to take the following steps:

- Wash the undercarriage of your vehicle regularly during the winter and whenever your vehicle has been exposed to such salts or chemicals.
- Do a thorough washing of the undercarriage at the end of the winter.
- Use professional service technicians or governmental inspection stations to annually inspect for corrosion.
- Immediately seek an inspection of your vehicle if you become visually aware of corrosion flaking or scaling

or if you become aware of a change in vehicle performance, such as soft or spongy brakes, fluids leaking, impairment of directional control, suspension noises or rattling metal straps.

## Aluminum wheel maintenance

The aluminum wheels are coated with a clear protective finish.

- Do not use any abrasive cleaner, polishing compound, solvent, or wire brushes on aluminum wheels. They may scratch or damage the finish.
- Clean the wheel when it has cooled.
- Use only a mild soap or neutral detergent, and rinse thoroughly with water. Also, be sure to clean the wheels after driving on salted roads. This helps prevent corrosion.
- Avoid washing the wheels with high speed vehicle wash brushes.
- Do not use any alkaline or acid detergents. It may damage and corrode the aluminum wheels coated with a clear protective finish.

## Corrosion protection

### Protecting your vehicle from corrosion

By using the most advanced design and construction practices to combat corrosion, we produce vehicles of the highest quality. However, this is only part of the job. To achieve the long-term corrosion resistance your vehicle can deliver, the owner's cooperation and assistance is also required.

### Common causes of corrosion

The most common causes of corrosion on your vehicle are:

- Road salt, dirt and moisture that is allowed to accumulate underneath the vehicle.
- Removal of paint or protective coatings by stones, gravel, abrasion or minor scrapes and dents which leave unprotected metal exposed to corrosion.

### High-corrosion areas

If you live in an area where your vehicle is regularly exposed to corrosive materials, corrosion protection is particularly important. Some of the common causes of accelerated corrosion are road salts, dust control chemicals, ocean air and industrial pollution.

### Moisture breeds corrosion

Moisture creates the conditions in which corrosion is most likely to occur. For example, corrosion is accelerated by high humidity, particularly when temperatures are just above freezing. In such conditions, the corrosive material is kept in contact with the vehicle's surface by moisture that evaporates slowly.

Mud is particularly corrosive because it dries slowly and holds moisture in contact with the vehicle. Although the mud appears to be dry, it can still retain the moisture and promote corrosion.

High temperatures can also accelerate corrosion of parts that are not properly ventilated so the moisture can be dispersed. For all these reasons, it is particularly important to keep your vehicle clean and free of mud or accumulations of other materials. This applies not only to the visible surfaces but particularly to the underside of the vehicle.

### To help prevent corrosion

You can help prevent corrosion from beginning by observing the following:

#### Keep your vehicle clean

The best way to prevent corrosion is to keep your vehicle clean and free of corrosive materials. Attention to the underside of the vehicle is particularly important.

If you live in a high-corrosion area — where road salts are used, near the ocean, areas with industrial pollution, acid rain, etc.—, you should take extra care to prevent corrosion. In winter, hose off the underside of your vehicle at least once a month and be sure to clean the underside thoroughly when winter is over.

When cleaning underneath the vehicle, give particular attention to the components under the fenders and other areas that are hidden from view. Do a thorough job; just dampening the accumulated mud rather than washing it away will accelerate corrosion rather than prevent it. Water under high pressure and steam are particularly effective in removing accumulated mud and corrosive materials.

When cleaning lower door panels, rocker panels and frame members, be sure that drain holes are kept open so that moisture can escape and not be trapped inside to accelerate corrosion.

#### Keep your garage dry

Don't park your vehicle in a damp, poorly ventilated garage. This creates a favorable environment for corrosion. This is particularly true if you wash your vehicle in the garage or drive it into the

garage when it is still wet or covered with snow, ice or mud. Even a heated garage can contribute to corrosion unless it is well ventilated so moisture is dispersed.

### Keep paint and trim in good condition

Scratches or chips in the finish should be covered with "touch-up" paint as soon as possible to reduce the possibility of corrosion. If bare metal is showing through, the attention of a qualified body and paint shop is recommended.

**Bird droppings:** Bird droppings are highly corrosive and may damage painted surfaces in just a few hours. Always remove bird droppings as soon as possible.

### Don't neglect the interior

Moisture can collect under the floor mats and carpeting and cause corrosion. Check under the mats periodically to be sure the carpeting is dry. Use particular care if you carry fertilizers, cleaning materials or chemicals in the vehicle.

These should be carried only in proper containers and any spills or leaks should be cleaned up, flushed with clean water and thoroughly dried.

### Interior care

Use the information in the following sections to maintain the interior of your vehicle.

### Interior general precautions

#### \* NOTICE

Prevent chemicals such as perfume, cosmetic oil, sun screen, hand cleaner, and air freshener from contacting the interior

parts because they may cause damage or discoloration. If they do contact the interior parts, wipe them off immediately. If necessary, use a mixture of warm water and mild non-detergent cleaner (test all cleaners on a concealed area before use). Use proper car cleaner to clean interior parts.

#### ⚠ CAUTION

### Electrical components

Never allow water or other liquids to come in contact with electrical/electronic components inside the vehicle as this may damage them.

#### ⚠ CAUTION

### Leather

When cleaning leather products (steering wheel, seats etc.), use neutral detergents or low alcohol content solutions. If you use high alcohol content solutions or acid/alkaline detergents, the color of the leather may fade or the surface may get stripped off.

### Taking care of leather seats (if equipped)

- Vacuum the seat periodically to remove dust and sand on the seat. It will prevent abrasion or damage of the leather and maintain its quality.
- Wipe the leather seat cover often with dry or soft cloth.
- Sufficient use of a leather protective may prevent abrasion of the cover and helps maintain the color. Be sure to read the instructions and consult a specialist when using leather coating or protectant.

- Leather with bright colors (beige, cream beige) is easily contaminated and clear in appearance. Clean the seats frequently.
- Avoid wiping with wet cloth. It may cause the surface to crack.

### **Cleaning the leather seats (if equipped)**

Remove all contaminations instantly. Refer to instructions below for removal of each contaminant.

- Cosmetic products (sunscreen, foundation, etc.)
  - Apply cleansing cream on a cloth and wipe the contaminated point. Wipe off the cream with a wet cloth and remove water with a dry cloth.
- Beverages (coffee, soft drink, etc.)
  - Apply a small amount of neutral detergent and wipe until contaminations do not smear.
- Oil
  - Remove oil instantly with absorbable cloth and wipe with stain remover for leather only.
- Chewing gum
  - Harden the gum with ice and remove gradually.

### **Fabric seat cover (if equipped)**

Please clean the fabric seats regularly with a vacuum cleaner in consideration of fabric material characteristics. If they are heavily soiled with beverage stains, etc., use a suitable interior cleaner. To prevent damage to seat covers, wipe off the seat covers down to the seams with a large wiping motion and moderate pressure using a soft sponge or microfiber cloth.

Velcro closures on clothing or sharp objects may cause snagging or scratches on the surface of the seats. Make sure not to rub such objects against the surface.

### **Cleaning the upholstery and interior trim**

#### **Car interior surfaces**

Remove dust and loose dirt from interior surfaces with a whisk broom or a vacuum cleaner. If necessary, clean interior surfaces with a mixture of warm water and mild non-detergent cleaner (test all cleaners on a concealed area before use).

#### **Fabric**

Remove dust and loose dirt from fabric with a whisk broom or vacuum cleaner. Clean with a mild soap solution recommended for upholstery or carpets. Remove fresh spots immediately with a fabric spot cleaner. If fresh spots do not receive immediate attention, the fabric can be stained and its color can be affected. Also, its fire-resistant properties can be reduced if the material is not properly maintained.

Using anything but recommended cleaners and procedures may affect the fabric's appearance and fire-resistant properties.

## Cleaning the lap/shoulder belt webbing

Clean the belt webbing with any mild soap solution recommended for cleaning upholstery or carpet. Follow the instructions provided with the soap. Do not bleach or re-dye the webbing because it may become loose.

## Cleaning the interior window glass

If the interior glass surfaces of the vehicle become fogged (that is, covered with an oily, greasy or waxy film), they should be cleaned with a glass cleaner. Follow the directions on the glass cleaner container.

### CAUTION

#### Rear window

Do not scrape or scratch the inside of the rear window. This may result in damage of the rear window defroster grid.

## Emission control system

The emission control system of your vehicle is covered by a written limited warranty. Please see the warranty information contained in the Warranty & Consumer Information manual in your vehicle.

Your vehicle is equipped with an emission control system to meet all applicable emission regulations. There are three emission control systems, as follows.

1. Crankcase emission control system
2. Evaporative emission control system
3. Exhaust emission control system

In order to assure the proper function of the emission control systems, it is recommended that you have your vehicle inspected and maintained by an authorized Kia dealer in accordance with the maintenance schedule in this manual.

### Caution for the Inspection and Maintenance Test (With Electronic Stability Control (ESC) system)

- To prevent the vehicle from misfiring during dynamometer testing, turn the ESC off by pressing the ESC switch.
- After dynamometer testing is completed, turn the ESC back on by pressing the ESC switch again.

### 1. Crankcase emission control system

The Positive Crankcase Ventilation system is employed to prevent air pollution caused by blow-by gases being emitted from the crankcase. This system supplies fresh filtered air to the crankcase through the air intake hose. Inside the

crankcase, the fresh air mixes with blow-by gases, which then pass through the Positive Crankcase Ventilation (PCV) valve into the induction system.

## 2. Evaporative emission control (including Onboard Refueling Vapor Recovery (ORVR)) system

The evaporative emission control system is designed to prevent fuel vapors from escaping into the atmosphere. (The ORVR system is designed to allow the vapors from the fuel tank to be loaded into a canister while refueling at the gas station, preventing the escape of fuel vapors into the atmosphere.)

### Canister

Fuel vapors generated inside the fuel tank are absorbed and stored in the onboard canister. When the engine is running, the fuel vapors absorbed in the canister are drawn into the surge tank through the Purge Control Solenoid Valve.

### Purge Control Solenoid Valve (PCSV)

The Purge Control Solenoid Valve (PCSV) is controlled by the Engine Control Module (ECM); when the engine coolant temperature is low during idling, the PCSV closes so that evaporated fuel is not taken into the engine. After the engine warms up during ordinary driving, the PCSV opens to introduce evaporated fuel to the engine.

## 3. Exhaust emission control system

The exhaust emission control system is a highly effective system which controls

exhaust emissions while maintaining good vehicle performance.

### Vehicle modifications

This vehicle should not be modified. Modification of your vehicle could affect its performance, safety or durability and may even violate governmental safety and emissions regulations.

#### \* NOTICE

Damage or performance problems resulting from any modification may not be covered under warranty.

- If you use unauthorized electronic devices, it may cause the vehicle to operate abnormally, wire damage, battery discharge and fire. For your safety, do not use unauthorized electronic devices.

### Engine exhaust gas precautions (carbon monoxide)

- Carbon monoxide can be present with other exhaust fumes. Therefore, if you smell exhaust fumes of any kind inside your vehicle, have it inspected and repaired immediately. If you ever suspect exhaust fumes are coming into your vehicle, drive it only with all the windows fully open. Have your vehicle checked and repaired immediately.

#### ⚠ WARNING

### Exhaust

Engine exhaust gases contain carbon monoxide (CO). Though colorless and odorless, it is dangerous and could be lethal if inhaled. Follow the instructions on this page to avoid CO poisoning.

- Do not operate the engine in confined or closed areas (such as garages) any more than what is necessary to move the vehicle in or out of the area.
- When the vehicle is stopped in an open area for an extended time with the engine running, adjust the ventilation system (as needed) to draw outside air into the vehicle.
- Never sit in a parked or stopped vehicle for any extended time with the engine running.
- When the engine stalls or fails to start, excessive attempts to restart the engine may cause damage to the emission control system.

### Operating precautions for catalytic converters

#### **WARNING**

#### **Catalytic converter**

Keep away from the catalytic converter and exhaust system while the vehicle is running or immediately thereafter. The exhaust and catalytic systems are very hot and may burn you.

#### **WARNING**

#### **Fire**

- Do not park, idle or drive the vehicle over or near flammable objects, such as grass, vegetation, paper, leaves, etc. A hot exhaust system can ignite flammable items under your vehicle.
- Also, do not remove the heat sink around the exhaust system, do not seal the bottom of the vehicle or do not coat the vehicle for corrosion control. It may present a fire risk under certain conditions.

Your vehicle is equipped with a catalytic converter emission control device.

Therefore, the following precautions must be observed:

- Use only UNLEADED FUEL for gasoline engines.
- Do not operate the vehicle when there are signs of engine malfunction, such as misfire or a noticeable underperformance.
- Do not misuse or abuse the engine. Examples of misuse are coasting with the ignition off and descending steep grades in gear with the ignition off.
- Do not operate the engine at high idle speed for extended periods (5 minutes or more).
- Do not modify or tamper with any part of the engine or emission control system. All inspections and adjustments must be made by an authorized Kia dealer.
- Avoid driving with an extremely low fuel level. Running out of fuel could cause the engine to misfire, damaging the catalytic converter.

Failure to observe these precautions could result in damage to the catalytic converter and to your vehicle. Additionally, such actions could void your warranties.



## California perchlorate notice

Perchlorate Material-special handling may apply, See

<https://dtsc.ca.gov/perchlorate>

Notice to California Vehicle Dismantlers: Perchlorate containing materials, such as air bag inflators, seatbelt pre-tensioners and keyless remote entry batteries, must be disposed of according to Title 22 California Code of Regulations Section 67384.10 (a).

# Specifications, Consumer information and Reporting safety defects

Dimensions .....	9-2
Engine .....	9-3
Gross vehicle weight .....	9-4
Luggage volume .....	9-5
Air conditioning system.....	9-6
Bulb wattage .....	9-7
Tires and wheels.....	9-8
Recommended lubricants and capacities .....	9-9
• Recommended SAE viscosity number.....	9-10
Vehicle Identification Number (VIN).....	9-11
Vehicle certification label.....	9-11
Tire specification and pressure label.....	9-12
Engine number.....	9-12
Refrigerant label.....	9-13
Consumer Assistance (U.S. only).....	9-13
Electrical Equipment (U.S. only) .....	9-15
Reporting Safety Defects (U.S. only) .....	9-16
Online factory authorized manuals (U.S. only) .....	9-17

# Specifications, Consumer information and Reporting safety defects

## Dimensions

Item		in (mm)	
Overall length		193.1 (4,905)	
Overall width		73.2 (1,860)	
Overall height	Standard	56.9 (1,445)	
Tread	Front	205/65 R16	64.3 (1,633)
		235/45 R18	63.7 (1,618)
		245/40 R19	63.4 (1,610)
	Rear	205/65 R16	64.6 (1,640)
		235/45 R18	64.0 (1,625)
		245/40 R19	63.7 (1,617)
Wheelbase		112.2 (2,850)	

## Engine

Item	Smartstream G1.6 T-GDi	Smartstream G2.5 T-GDi
Displacement [cu in (cc)]	97.5 (1,598)	152.4 (2,497)
Bore x Stroke [in (mm)]	3.0 x 3.5 (75.6 x 89.0)	3.5 x 4.0 (88.5 x 101.5)
Firing order	1-3-4-2	1-3-4-2
No. of cylinders	4, In-line	4, In-line

## Gross vehicle weight

Item		Smartstream G1.6 T-GDi	Smartstream G2.5 T-GDi
Gross vehicle weight [lbs. (kg)]	FWD	4,354 (1,975)	4,564 (2,070)
	AWD	4,497 (2,040)	-

## Luggage volume

Item	Smartstream G1.6 T-GDi / Smartstream G2.5 T-GDi
SAE [cu.ft (L)]	16 (453)

## Air conditioning system

Item	Weight of volume	Classification
Refrigerant [oz. (g)]	18.3 ± 0.88 (520 ± 25)	R-1234yf
Compressor lubricant [oz. (g)]	3.5 ± 0.4 (100 ± 10)	PAG (FD46XG)

Contact an authorized Kia dealer for more details.

## Bulb wattage

Light bulb		Bulb type	Wattage (Watt)	
Front	Type A *	High beam	LED	-
		Low beam	LED	-
		Position and daytime running lamps	LED	-
		Turn signal lamps	LED	-
	Type B *	High beam	LED	-
		Low beam	LED	-
		Auxiliary low beam	LED	-
		Position and daytime running lamps	LED	-
		Turn signal lamps	LED	-
	Front side marker lamps		LED	-
	Front fog lamps (Type A) *		LED	-
	Front fog lamps (Type B) *		LED	-
	Turn signal lamp (installed in outside rear view mirror) *		LED	-
Rear	Type A *	Stop and tail lamps	21/5W	21/5
		Tail lamps	W5W	5
		Turn signal lamps	PY21W	21
		Back up lamps	W16W	16
		Side marker lamps	LED	-
	Type B *	Stop lamps	LED	-
		Tail lamps (outside)	LED	-
		Tail lamps (center)	LED	-
		Turn signal lamps	PY21W	21
		Back up lamps	W16W	16
		Side marker lamps	LED	-
	High mounted stop lamps		LED	-
	License plate lamps		W5W	5
Interior	Map lamps		LED	-
	Room lamps *		LED	-
	Personal lamps *		LED	-
	Vanity mirror lamps *		BULB	5
	Luggage lamp		FESTOON	5

\*: if equipped



## Tires and wheels

Item	Tire size	Wheel size	Load capacity		Speed capacity		Inflation pressure [bar (psi, kPa)]				Wheel lug nut torque lbf-ft, N·m (kgf-m)
			L <sup>1</sup> ²	lbs. (kg)	SS <sup>3</sup>	mph (km/h)	Normal load <sup>1</sup>		Maximum load		
							Front	Rear	Front	Rear	
Full size tire	205/65 R16	6.5J x16	95	1,521 (690)	H	130 (210)	2.4 (35, 240)	2.4 (35, 240)	2.4 (35, 240)	2.4 (35, 240)	79-94, 107-127 (11-13)
	235/45 R18	7.5J x18	94	1,477 (670)	V	149 (240)					
	245/40 R19 <sup>*4</sup>	8.0J x19	94	1,477 (670)	W	168 (270)					
Compact spare tire	T125/80D16	4T x 16	97	1,609 (730)	M	81 (130)	4.2 (60,420)	4.2 (60,420)	4.2 (60,420)	4.2 (60,420)	
	T135/80R18 <sup>*4</sup>	4B x 18	104	1,984 (900)	M	81 (130)					

\*1. Up to 3 persons

\*2. Load Index

\*3. Speed Symbol

\*4. If equipped

### **⚠ CAUTION**

When replacing tires, use the same size originally supplied with the vehicle.

Using tires of a different size can damage the related parts or make it work irregularly.

### **\* NOTICE**

- We recommend that when replacing tires, use the same originally supplied with the vehicles.

If not, that affects driving performance.

- When driving in high altitude grades, it is natural for the atmospheric pressure to decrease.

Therefore, please check the tire pressure and add more air when necessary.

Additionally required tire air pressure per km above sea level: 1.5 psi/km

## Recommended lubricants and capacities

To help achieve proper engine and powertrain performance and durability, use only lubricants of the proper quality.

The correct lubricants also help promote engine efficiency that results in improved fuel economy.

These lubricants and fluids are recommended for use in your vehicle.

Lubricant		Volume	Classification
Engine oil (drain and refill) <sup>1</sup>  	Smartstream G1.6 T-GDi	5.07 US qt.(4.8 L)	Full synthetic SAE 0W-20, API SN PLUS/SP or ILSAC GF-6
	Smartstream G2.5 T-GDi	6.1 US qt.(5.8 L)	Full synthetic SAE 0W-30, API SN PLUS/SP or ILSAC GF-6
Automatic transmission (AT) fluid <sup>2</sup>	Smartstream G1.6 T-GDi	6.87 US qt.(6.5 L)	SK ATF SP4M-1, MICHANG ATF SP4M-1, S-OIL ATF SP4M-1, Kia Genuine ATF SP4M-1
Dual clutch transmission (DCT) fluid (Gear oil) <sup>3</sup>	Smartstream G2.5 T-GDi	3.48~3.59 US qt.(3.3~3.4 L)	Kia Genuine oil (WET DCTF 75W or WET DCT FLUID)
Dual clutch transmission (DCT) fluid (Control oil) <sup>3</sup>		2.59~2.64 US qt.(2.45~2.5 L)	Kia Genuine oil (WET DCT HYDRAULIC OIL or WET DCT HYDRAULIC CONTROL OIL)
Differential oil (rear) (AWD)	Smartstream G1.6 T-GDi	0.61±0.05 US qt.(0.58±0.05 L)	Hypoid gear oil API GL-5, SAE 75W/85
Transfer case oil (AWD)	Smartstream G1.6 T-GDi	0.69 US qt.(0.65 L)	(SK HCT-5 75W/85 or equiv <sup>4</sup> alent)
Coolant <sup>4</sup>	Smartstream G1.6 T-GDi	8.45 US qt.(8.0 L)	An Phosphate based ethylene glycol based coolant
	Smartstream G2.5 T-GDi	9.29 US qt.(8.8 L)	
Brake fluid		As required	SAE J1704 DOT-4 LV, ISO4925 CLASS-6, FMVSS116 DOT-4
Fuel	Smartstream G1.6 T-GDi (AWD)	14.79 US gal. (56 L)	Gasoline
	Smartstream G1.6 T-GDi (2WD) / Smartstream G2.5 T-GDi (2WD)	15.85 US gal. (60 L)	

\* 1. Refer to "Recommended SAE viscosity number" on page 9-10.

\* 2. Use only specified genuine automatic transmission fluid. The use of non-specified (even marked as compatible with genuine) could result in shift quality deterioration and vibrations, eventually, the transmission failure. (Refer to "Scheduled maintenance service" on page 8-9)

\* 3. If the genuine oil that is developed for best performance is not used, it may cause the problems of transmission performance.

\* 4. Different type of coolant or water may damage the electrical component.

### Recommended SAE viscosity number

Temperature Range for SAE Viscosity Numbers										
Temperature	°C	-30	-20	-10	0	10	20	30	40	50
	°F	-10	0	20	40	60	80	100	120	
Gasoline Engine Oil	Smartstream G1.6 T-GDi	0W-20								
	Smartstream G2.5 T-GDi	0W-30								



An engine oil displaying this American Petroleum Institute (API) Certification Mark conforms to the International Lubricant Specification Advisory Committee (ILSAC). It is recommended to only use engine oils that uphold this API Certification Mark.

Engine oil viscosity (thickness) has an effect on fuel economy and cold weather operating (engine start and engine oil flowability). Lower viscosity engine oils can provide better fuel economy and cold weather performance, however, higher viscosity engine oils are required for satisfactory lubrication in hot weather.

Using oils of any viscosity other than those recommended could result in engine damage.

#### \* NOTICE

Never add any additives to the engine oil. Engine oil additives can change the properties of engine oil and may cause serious engine failure.

When choosing an oil, consider the range of temperature your vehicle will be operated in before the next oil change. Proceed to select the recommended oil viscosity from the chart.

#### ⚠ CAUTION

Always be sure to clean the area around any filler plug, drain plug, or dipstick before checking or draining any lubricant. This is especially important in dusty or sandy areas and when the vehicle is used on unpaved roads. Cleaning the plug and dipstick areas will prevent dirt and grit from entering the engine and other mechanisms that could be damaged.

## Vehicle Identification Number (VIN)

The Vehicle Identification Number (VIN) is the number used in registering your vehicle and in all legal matters pertaining to its ownership, etc.

The VIN is also on a plate attached to the top of the dashboard. The number on the plate can easily be seen through the windshield from outside.

VIN label



## Vehicle certification label



The vehicle certification label attached on the driver's (or front passenger's) side center pillar gives the vehicle identification number (VIN).

## Tire specification and pressure label



The tires supplied on your new vehicle are chosen to provide the best performance for normal driving.

The tire label located on the driver's side center pillar gives the tire pressures recommended for your vehicle.

## Engine number

The engine number is stamped on the engine block as shown in the drawing.

Smartstream G1.6 T-GDi

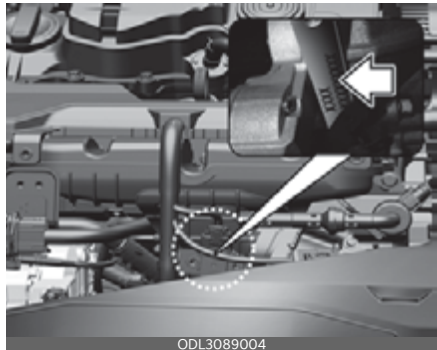

Smartstream G2.5 T-GDi



## Refrigerant label



The refrigerant label is located on the underside of the hood.

## Consumer Assistance (U.S. only)

Roadside Assistance is provided on all new current model year Kia Vehicles from the date the vehicle is delivered to the first retail buyer or otherwise put into use (inservice date), whichever is earlier, for a period of 60 months or 60,000 miles, whichever is earlier, subject to the terms, conditions and exclusions set forth in the Kia Warranty and Consumer Information Manual applicable to your model year vehicle.

Kia America, Inc. reserves the right to limit or deny services or other benefits to any owner or driver when, in Kia America, Inc.'s judgment, the claims and/or service requests are excessive in frequency or type of occurrence.

### Toll free consumer assistance

is available from 5:00 AM to 6:00 PM PST, Monday through Friday and is accessible by dialing 1-800-333-4Kia (4542).

For more information regarding assistance available, please refer to your Kia Warranty & Consumer Information Manual.

### Emergency roadside assistance

is available 24 hours a day, 365 days a year and is accessible by dialing 1-800-333-4Kia (4542).

Please note that you must provide your Vehicle Identification Number (VIN) to verify coverage at the time of your call. The VIN can be found on the dash of your vehicle on the driver's side, on the door jamb of the driver's door, your vehicle's registration or proof of insurance card.

Kia utilizes a network of over 30,000 roadside assistance providers. Should you accidentally run out of fuel, require a battery jump, or need help changing a tire, a Kia Roadside Assistance Representative will dispatch someone to deliver a small quantity of gas, change a flat tire with your inflated spare, or arrange a battery jump to allow you to proceed to your destination. We have access to a network of over 10,000 locksmiths to help you should you become locked out of your Kia.

In the event that mechanical difficulty renders your vehicle undriveable due to a warranty-related concern, Kia's Roadside Assistance Representative will arrange to transport your vehicle to the nearest Kia dealer or to an authorized Kia alternative service location.

Your vehicle must be accessible to our dispatch transport vehicle, as determined by our driver, to receive this service.

#### \* NOTICE

Roadside Assistance benefits are not available for any Kia vehicle that has ever been or should have been issued a "salvage" title or similar "branded" title under any state's law or has been declared a "total loss" or equivalent by a financial institution or insurance company.

### Trip interruption

Trip interruption expense benefits are provided in the event that a warranty-related disablement occurs more than 150 miles from your home, and the repairs require more than 24 hours to complete. Reasonable reimbursement is included for meals, lodging, or rental

vehicle expenses. Trip interruption coverage is limited to \$100 per day subject to a three day maximum limit per incident. You must contact the Kia Roadside Assistance Center to obtain pre-authorization of expenses. Once the Kia Roadside Assistance Center gives authorization for trip interruption benefits, they will assist you in making the necessary arrangements. Insurance deductibles, expenses, and claims paid by your insurance company or other providers are not eligible for reimbursement.

Fleet vehicles are excluded from reimbursement under Kia's Trip Interruption Policy.

### Registering your vehicle in a foreign country

If you plan to register your vehicle in a foreign country, you should confirm that it conforms to the regulations in that country. Even if you successfully register the vehicle in a foreign country, you may experience the following problems and should therefore consider the possibility of having to deal with them:

1. The fuel specified for your vehicle may be unavailable. If other than the specified fuel is used, it could cause damage to the engine, the fuel injection system, and other fuel-related parts which may not be covered under your New Vehicle Emissions Limited Warranty.
2. We must, therefore, clearly state that when you leave the country in which you purchased your Kia new and register it in another country, problems arising from the use of fuel other than the specified fuel are not subject to manufacturer's warranty. Because

vehicles like yours may not be marketed in the new country of registration, parts, servicing techniques and tools necessary to maintain and repair your vehicle may be unavailable.

Even if vehicles like yours are sold there, mechanical specifications required by the government may vary enough from the country of purchase to cause additional problems.

3. There may not be an Authorized Kia Dealer in the area in which you plan to register your vehicle. You may additionally experience difficulty in obtaining services in a foreign country for any number of reasons.

Further, we cannot assume any responsibility for problems that result from unsatisfactory service or lack of service outside of the United States.

## Electrical Equipment (U.S. only)

The electrical system of your vehicle is designed to perform under all reasonably expected operating conditions.

However, before any additional electrical equipment is installed in your vehicle, consult an Authorized Kia Dealer, in order to ensure that you do not void your warranty.

Certain electrical equipment, or the way in which it is installed, may adversely affect the operation of your vehicle, including such systems as the engine control system, the audio system and the electrical charging system and thus potentially void all or part of your warranty.

We assume no responsibility for any expense you may incur or for any malfunction of your vehicle or any of its components or systems that may result from the installation of additional electrical equipment that is not supplied, or recommended for installation by, Kia.

## Installation of a mobile two-way radio system

If a mobile two-way radio system is installed improperly, or if an excessively powerful type of system is used, other electronic systems may be adversely affected. To avoid damage to your vehicle, consult an Authorized Kia Dealer concerning the proper equipment and installation.

Kia vehicles are designed and manufactured to meet or exceed all applicable safety standards.

For your safety, however, we strongly urge you to read and follow all directions in this Owner's Manual, particularly the



information under the headings "NOTICE", "CAUTION" and "WARNING".

If, after reading this manual, you have any questions regarding the operation of your vehicle, safety issues and defects, please contact your Kia's toll-free Consumer Assistance hot line as below:

National Consumer Affairs Manager

Kia America, Inc.

P.O. Box 52410

Irvine, CA 92619-2410

1-800-333-4Kia (4542)

## Reporting Safety Defects (U.S. only)

If you believe that your vehicle has a defect which could cause a crash or could cause injury or death, you should immediately inform the National Highway Traffic Safety Administration (NHTSA) in addition to notifying **Kia America, Inc.**

If NHTSA receives similar complaints, it may open an investigation, and if it finds that a safety defect exists in a group of vehicles, it may order a recall and remedy campaign. However, NHTSA cannot become involved in individual problems between you, your dealer, or **Kia America, Inc.**

To contact NHTSA, you may call the Vehicle Safety Hotline toll-free at 1-888-327-4236 (TTY: 1-800-424-9153); go to <http://www.safercar.gov>; download the SaferCar mobile application; or write to: Administrator, NHTSA, 1200 New Jersey Ave. SE., Washington, DC 20590.

You can also obtain other information about motor vehicle safety from <http://www.safercar.gov>.

## **Online factory authorized manuals (U.S. only)**

The following publications are available on [www.KiaTechinfo.com](http://www.KiaTechinfo.com).

### **Service manual**

This manual covers maintenance and recommended procedures for repair to engine and chassis components. It is written for the Journeyman mechanic, but is simple enough for most mechanically inclined owners to understand.

### **Electrical troubleshooting manual**

This manual complements the Service Manual by providing in-depth troubleshooting information for each electrical circuit in your vehicle.

### **Owner's manual**

This manual describes the overall features and operating procedures for the vehicle.



# Abbreviation **A**

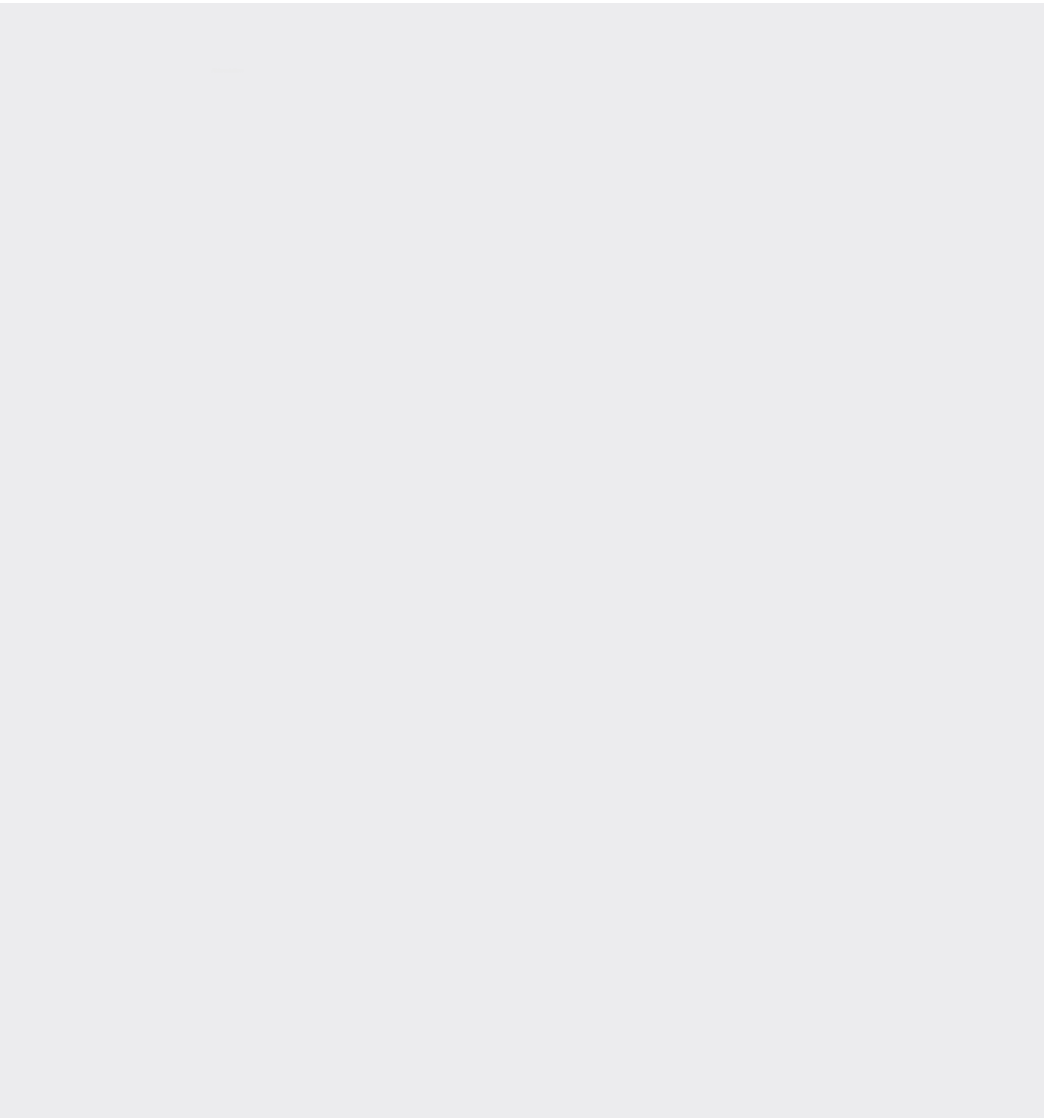

## Abbreviation

### Abbreviation

#### ABS

Anti-lock Brake System

#### BCA

Blind-Spot Collision-Avoidance Assist

#### BCW

Blind-Spot Collision Warning

#### CC

Cruise Control

#### CRS

Child Restraint System

#### DAW

Driver Attention Warning

#### DRL

Daytime Running Light

#### EBD

Electronic Brake force Distribution

#### ECM

Electric Chromic Mirror

#### ESC

Electronic Stability Control

#### FCA

Forward Collision-Avoidance Assist

#### HAC

Hill-start Assist Control

#### HBA

High Beam Assist

#### HDA

Highway Driving Assist

#### HMSL

High Mounted Stop Lamp

#### HUD

Head-Up Display

#### LATCH

Lower Anchors and Tether for Children

#### LFA

Lane Following Assist

#### LKA

Lane Keeping Assist

#### MDPS

Motor Driven Power Steering

#### MIL

Malfunction Indicator Lamp

#### NSSC

Navigation-based Smart Cruise Control

#### ODS

Occupant Detection System

#### PCA

Reverse Parking Collision-Avoidance Assist

#### PDW

Reverse Parking Distance Warning

#### RCCA

Rear Cross-Traffic Collision-Avoidance Assist

#### RCCW

Rear Cross-Traffic Collision Warning

#### ROA

Rear Occupant Alert system

**Abbreviation**

**RVM**

Rear View Monitor

**SBW**

Shift-By-Wire

**SCC**

Smart Cruise Control

**SEA**

Safe Exit Assist

**SEW**

Safe Exit Warning

**SRS**

Supplemental Restraint System

**SRSCM**

SRS Control Module

**SVM**

Surround View Monitor

**TBT**

Turn By Turn

**TCS**

Traction Control System

**TIN**

Tire Identification Number

**TPMS**

Tire Pressure Monitoring System

**VIN**

Vehicle Identification Number

**VSM**

Vehicle Stability Management



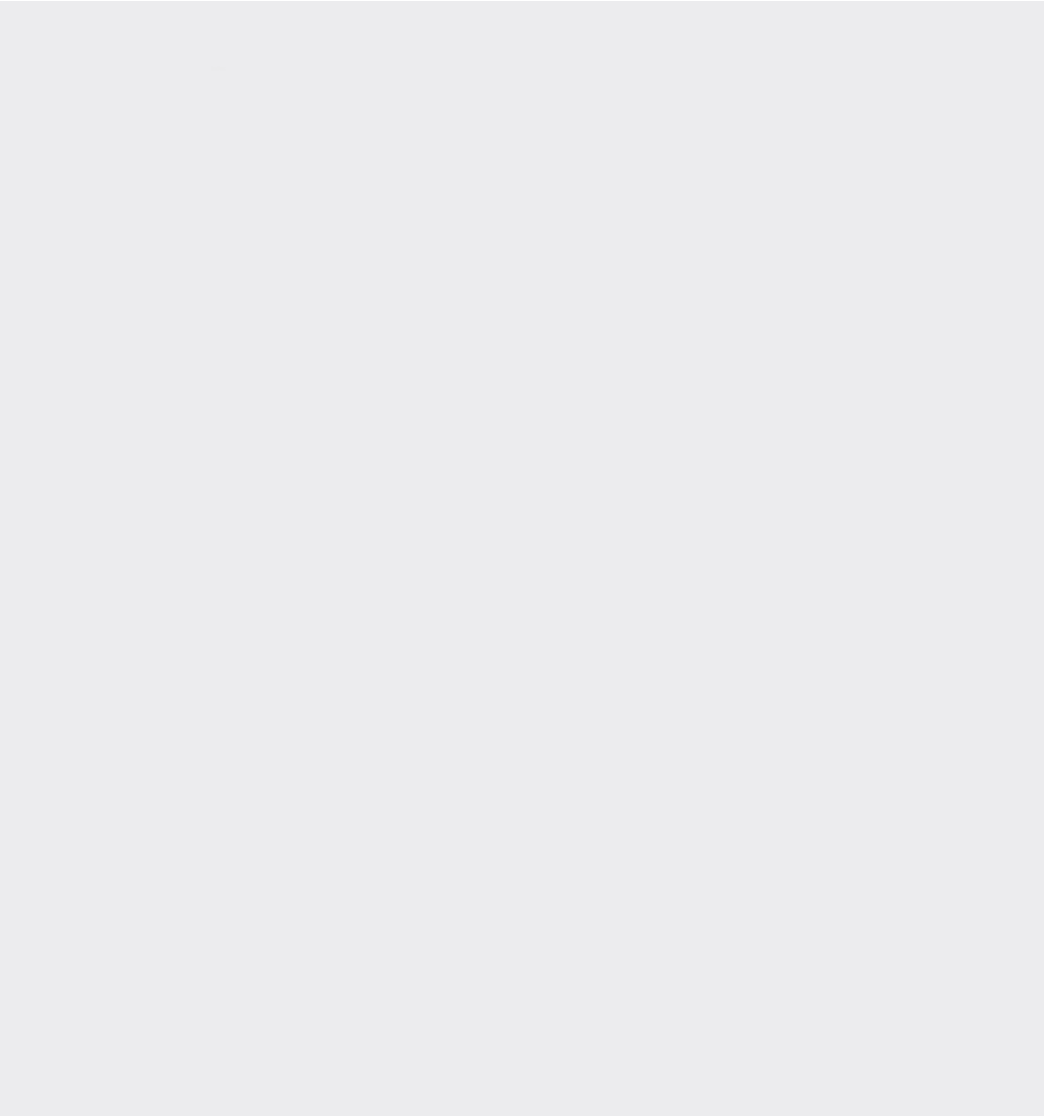



# Index

## A

<b>air bag warning label</b>	3-57
<b>air bags</b>	3-34
adding equipment to or modifying your	
air bag-equipped vehicle	3-57
additional safety precautions	3-55
air bag collision sensors	3-51
air bag warning label	3-57
curtain air bag	3-49
driver's and passenger's front	
air bag	3-45
inflation conditions	3-52
non-inflation conditions	3-53
occupant detection system (ODS)	3-40
operation of the system	3-35
side air bag	3-48
SRS components and functions	3-37
supplemental restraint system (SRS)	3-55
warning light	3-37
<b>air cleaner filter</b>	8-26
replacing air cleaner filter	8-26
<b>air ventilation seat</b>	4-128
<b>all wheel drive (AWD)</b>	5-23
<b>antenna</b>	4-135
<b>anti-lock brake system (ABS)</b>	5-36
<b>appearance care</b>	8-68
exterior care	8-68
interior care	8-73
<b>armrest</b>	3-14
<b>auto defogging system</b>	4-121
<b>auto hold</b>	5-33
<b>automatic climate control system</b>	4-111
active upon washer fluid use	4-119
air conditioning	4-117
automatic air ventilation	4-118
controlling air intake	4-117
controlling fan speed	4-117
heating and air conditioning	
automatically	4-112
heating and air conditioning	
manually	4-114
mode selection	4-115
sunroof inside air recirculation	4-119

temperature control	4-116
turning off the front air climate control	4-118
<b>automatic transmission</b>	5-8
ignition key interlock system	5-12
manual mode	5-11
operation	5-8
shift-lock system	5-12

## B

<b>battery</b>	8-31
for best battery service	8-31
<b>before driving</b>	5-3
<b>blind-spot collision-avoidance assist (BCA)</b>	6-37
detecting sensor	6-38
malfunction and limitations	6-44
operation	6-41
settings	6-39
<b>brake fluid</b>	8-24
checking the brake fluid level	8-24
<b>brake system</b>	5-27
anti-lock brake system (ABS)	5-36
auto hold	5-33
electronic parking brake (EPB)	5-29
electronic stability control (ESC)	
system	5-37
hill-start assist control (HAC)	5-41
power brakes	5-27
vehicle stability management (VSM)	
system	5-40
<b>bulb replacement precaution</b>	8-59

## C

<b>california perchlorate notice</b>	8-78
<b>child restraint system (CRS)</b>	3-26
installing a CRS	3-29
selecting a CRS	3-27
types	3-28
<b>child-protector rear door lock</b>	4-20
<b>climate control air filter</b>	8-28
inspecting and replacing climate control air filter	8-28
<b>climate control system</b>	4-107
operation	4-107
<b>consumer assistance</b>	9-13

<b>cruise control (CC)</b>	6-65
accelerating temporarily with cruise control on	6-66
cruise control switch	6-65
decreasing cruise control set speed	6-66
increasing cruise control set speed	6-66
setting cruise control speed	6-66
turning cruise control off	6-68
<b>cup holder</b>	4-125

## D

<b>day/night rear view mirror</b>	4-49
<b>declaration of conformity</b>	4-138
<b>defogging (windshield)</b>	4-120
<b>door locks</b>	4-16
child-protector rear door lock	4-20
door lock/unlock features	4-20
electronic child safety lock system in case of an emergency	4-21
operating door locks from inside the vehicle	4-18
rear occupant alert (ROA)	4-22
with the mechanical key	4-16
with the smart key	4-16
<b>drive mode</b>	5-44
<b>drive mode integrated control system</b>	5-44
drive mode	5-44
smart shift on trip computer	5-48
vehicle characteristics	5-50
<b>driver attention warning (DAW)</b>	6-57
detecting sensor	6-57
leading vehicle departure alert	6-57
malfunction and limitations	6-62
operation	6-60
settings	6-58
<b>driver position memory system</b>	4-24
driver position memory system reset	4-25
easy access function	4-25
recalling memory positions	4-24
storing memory positions	4-24
<b>driving assist mode</b>	4-70
<b>dual clutch transmission (DCT)</b>	5-14
DCT warning messages	5-16
operation	5-14
paddle shifter	5-20
ranges	5-17

shift lock system	5-21
-------------------	------

## E

<b>economical operation</b>	5-53
<b>electric Chromic Mirror (ECM)</b>	4-49
<b>electrical equipment</b>	9-15
<b>electrochromic mirror (ECM) with HomeLink® system</b>	4-50
<b>electronic child safety lock system</b>	4-21
<b>electronic parking brake (EPB)</b>	5-29
applying the parking brake	5-29
EPB malfunction	5-33
EPB warning messages	5-31
releasing the parking brake	5-30
<b>electronic stability control (ESC) system</b>	5-37
<b>emergency</b>	7-2
emergency starting	7-4
hazard warning flasher	7-2
if engine doesn't turn over or turns over slowly	7-3
if engine turns over normally but does not start	7-3
if the engine stalls at a crossroad or crossing	7-2
if the engine will not start	7-3
if the vehicle stalls while driving	7-2
if you have a flat tire while driving	7-2
in case of an emergency while driving	7-2
road warning	7-2
<b>emergency starting</b>	7-4
jump-starting	7-4
push-starting	7-6
<b>emission control system</b>	8-75
<b>engine coolant</b>	8-21
changing the coolant	8-23
checking the coolant level	8-22
<b>engine number</b>	9-12
<b>engine oil and filter</b>	8-18
changing the engine oil and filter	8-19
checking the engine oil level	8-18
<b>engine overheats</b>	7-6
<b>engine start/stop button</b>	5-5
engine start/stop button position	5-5
illuminated engine start/stop button	5-5

starting the engine 5-7

---

## F

**flat tire** 7-12  
changing tires 7-14  
jack and tools 7-12  
jack label 7-20  
removing and storing the spare tire 7-14  
using of compact spare tire 7-18  
**forward collision-avoidance assist (FCA) - front view camera only** 6-4  
detecting sensor 6-4  
forward collision-avoidance assist operation 6-7  
forward collision-avoidance assist settings 6-5  
malfunction and limitations 6-10  
**forward collision-avoidance assist (FCA) - sensor fusion** 6-16  
detecting sensor 6-16  
forward collision-avoidance assist operation 6-20  
forward collision-avoidance assist settings 6-17  
malfunction and limitations 6-24  
**forward/reverse parking distance warning (PDW)** 6-114  
detecting sensor 6-114  
forward/reverse parking distance warning malfunction and limitations 6-117  
forward/reverse parking distance warning operation 6-116  
forward/reverse parking distance warning settings 6-115  
**fuel filler door** 4-38  
closing the fuel filler door 4-39  
opening the fuel filler door 4-38  
**fuel gauge** 4-65  
**fuel requirements** 1-2  
**fuses** 8-47  
fuse/relay panel description 8-51  
replacing engine compartment fuse 8-50  
replacing inner panel fuse 8-49

---

## G

**gauges** 4-64  
distance to empty 4-66  
engine coolant temperature gauge 4-65  
fuel gauge 4-65  
odometer 4-66  
outside temperature gauge 4-67  
speedometer 4-64  
tachometer 4-64  
**glove box** 4-124  
**good braking practices** 5-41

---

## H

**hazardous driving conditions** 5-54  
**head light (low beam)** 4-96  
**head-up display (HUD)** 4-93  
head up display information 4-94  
head up display setting 4-94  
**heated steering wheel** 4-47  
**high beam assist (HBA)** 4-99  
**highway driving assist (HDA)** 6-95  
detecting sensor 6-95  
highway driving assist malfunction and limitations 6-99  
highway driving assist operation 6-97  
highway driving assist settings 6-96  
**hill-start assist control (HAC)** 5-41  
**hood** 4-36  
closing the hood 4-37  
hood open warning 4-37  
opening the hood 4-36  
**horn** 4-48

---

## I

**illuminated engine start/stop button** 5-5  
**immobilizer system** 4-12  
folding key immobilizer system 4-12  
smart key immobilizer system 4-12  
**infotainment system** 4-135  
**instrument cluster** 4-63  
**interior features** 4-125  
**interior light** 4-105  
automatic turn off function 4-105

luggage room lamp	4-106
map lamp	4-105
room lamp	4-106
vanity mirror lamp	4-107

---

## J

<b>jump-starting</b>	7-4
----------------------	-----

---

## K

<b>keys</b>	4-6
battery replacement	4-6
remote key	4-7
smart key	4-9

---

## L

<b>lane following assist (LFA)</b>	6-90
detecting sensor	6-90
lane following assist malfunction and limitations	6-94
lane following assist operation	6-92
lane following assist settings	6-91
<b>lane keeping assist (LKA)</b>	6-31
detecting sensor	6-31
lane keeping assist malfunction and limitations	6-35
lane keeping assist operation	6-33
lane keeping assist settings	6-31
<b>launch control</b>	5-51
limitations	5-52
operation	5-51
<b>LCD display</b>	4-68
information	4-71
LCD Display Control	4-68
LCD display modes	4-69
<b>LCD display modes</b>	
driving assist mode	4-70
information mode	4-71
master warning mode	4-71
trip computer mode	4-70
turn by turn (TBT) mode	4-70
user settings mode	4-72
<b>LCD displays</b>	
LCD display messages	4-81
service mode	4-80
trip information (trip computer)	4-78

<b>light bulbs</b>	8-59
<b>lighting</b>	4-95
auto light	4-97
battery saver function	4-95
daytime running light (DRL)	4-95
head light (low beam)	4-96
headlamp delay function	4-95
high beam assist (HBA)	4-99
lighting control	4-96
one-touch lane change	4-98
operating front fog light	4-99
operating high beam	4-97
operating turn signals and lane change signal	4-98
position & tail lamp	4-96
<b>luggage net holder</b>	4-124

---

## M

<b>maintenance</b>	
engine compartment	8-4
maintenance services	8-6
owner maintenance	8-7
scheduled maintenance items	8-15
scheduled maintenance service	8-9
<b>map lamp</b>	4-105
<b>master warning mode</b>	4-71
<b>mirrors</b>	4-49
electric Chromic Mirror (ECM)	4-49
electrochromic mirror (ECM)	
with HomeLink® system	4-50
inside rear view mirror	4-49
outside rear view mirror	4-60
<b>motor driven power steering (MDPS)</b>	4-46

---

## N

<b>navigation-based smart cruise control (NSCC)</b>	6-84
highway curve zone auto slowdown	6-84
highway set speed auto change	6-84
navigation-based smart cruise control operation	6-85
navigation-based smart cruise control setting	6-84

---

## O

occupant detection system (ODS)	3-40
odometer	4-66
one-touch lane change	4-98
online factory authorized manuals	9-17
opening the hood	4-36
operating high beam	4-97
outside rear view mirror	4-60
outside temperature gauge	4-67
overloading	5-67
owner maintenance	8-7

---

## P

panoramic sunroof	4-42
automatic reversal	4-44
resetting the sunroof	4-45
slide open/close	4-43
sunshade	4-43
tilt open/close	4-43
power brakes	5-27
power outlet	4-130
power window lock button	4-35
pre-tensioner seat belt	3-22
push-starting	7-6

---

## R

rear cross-traffic collision-avoidance assist (RCCA)	6-119
rear occupant alert (ROA)	4-22
rear view monitor (RVM)	6-101
recommended SAE viscosity number	9-10
refrigerant label	9-13
remote key	4-7
mechanical key	4-8
operation	4-7
transmitter precautions	4-8
replacing front fog lamp bulb (LED type)	8-62

replacing headlamp, position lamp/daytime running lamp, turn signal lamp bulb (LED type)	8-62
replacing high mounted stop lamp bulb (LED type)	8-64
replacing license plate lamp bulb (bulb type)	8-65
replacing map lamp bulb (bulb/LED type)	8-65
replacing personal lamp bulb (LED type)	8-67
replacing rear tail & stop lamp, stop lamp, turn signal lamp, back up lamp bulb	8-63
replacing room lamp bulb (bulb type)	8-67
replacing room lamp bulb (LED type)	8-67
replacing side repeater lamp bulb (LED type)	8-63
replacing tail lamp, tail & stop lamp bulb (LED type)	8-64
replacing trunk room lamp (bulb type)	8-68
replacing vanity mirror lamp bulb (bulb type)	8-66
reporting safety defects	9-16
reverse parking collision-avoidance assist (PCA)	6-130
reverse parking distance warning (PDW)	6-110
detecting sensor	6-110
reverse parking distance warning malfunction and precautions	6-113
reverse parking distance warning operation	6-112
reverse parking distance warning settings	6-112, 6-115
types of warning sound and indicator	6-113

---

## S

safe exit assist (SEA)	6-52
detecting sensor	6-52
malfunction and limitations	6-56

operation	6-54	driving in the rain	5-55
settings	6-53	hazardous driving conditions	5-54
<b>safe exit warning (SEW)</b>	6-48	highway driving	5-56
detecting sensor	6-48	hydroplaning	5-56
malfunction and limitations	6-50	rocking the vehicle	5-54
operation	6-49	smooth cornering	5-55
settings	6-48	<b>specifications</b>	9-2
<b>safety precautions</b>	3-3	air conditioning system	9-6
<b>seat</b>	3-5	bulb wattage	9-7
front seat adjustment for manual seat	3-8	dimensions	9-2
front seat adjustment for power seat	3-9	engine	9-3
front seat headrest	3-10	gross vehicle weight	9-4
rear seat adjustment	3-13	lubricants and capacities	9-9
seat leather	3-7	luggage volume	9-5
seatback pocket	3-13	tires and wheels	9-8
<b>seat belts</b>	3-17	<b>speedometer</b>	4-64
3-point system with emergency locking		<b>starting the engine</b>	5-7
retractor	3-18	<b>steering wheel</b>	4-46
care of seat belts	3-25	heated steering wheel	4-47
child restraint system (CRS)	3-26	horn	4-48
front passenger and rear seat 3-point		motor driven power steering (MDPS)	4-46
system with combination locking		tilt & telescopic steering wheel	4-47
retractor	3-20	<b>storage compartment</b>	4-124
precautions	3-23	center console storage	4-124
pre-tensioner seat belt	3-22	glove box	4-124
seat belt restraint system	3-17	luggage net holder	4-124
warning	3-18	<b>sun visor</b>	4-128
<b>seat leather</b>	3-7	<b>supplemental restraint system (SRS)</b>	3-55
<b>seatback pocket</b>	3-13	<b>surround view monitor (SVM)</b>	6-105
<b>smart cruise control (SCC)</b>	6-68	detecting sensor	6-105
detecting sensor	6-68	function malfunction	
overtaking acceleration assist	6-68	and limitations	6-109
smart cruise control display		surround view monitor operation	6-108
and control	6-73	surround view monitor settings	6-105
smart cruise control malfunction			
and limitations	6-78		
smart cruise control operation	6-73		
smart cruise control settings	6-69		
<b>smart key</b>	4-9		
mechanical key	4-10	<b>T</b>	
operation	4-9	<b>tachometer</b>	4-64
<b>smart trunk</b>	4-28	<b>theft-alarm system</b>	4-13
detecting area	4-30	armed stage	4-14
how to deactivate	4-30	disarmed stage	4-15
how to use	4-28	theft-alarm stage	4-15
<b>special driving conditions</b>	5-54	<b>tilt &amp; telescopic steering wheel</b>	4-47
driving at night	5-55	<b>tire chains</b>	5-58
driving in flooded areas	5-56	<b>tire pressure monitoring system (TPMS)</b>	7-8
		effective use of the TPMS	7-8

low tire pressure telltale	7-9
tire replacement with TPMS	7-11
TPMS malfunction indicator	7-10
<b>tire specification and pressure label</b>	9-12
<b>tires and wheels</b>	8-33
all season tires	8-44
checking tire inflation pressure	8-35
low aspect ratio tire	8-46
radial-ply tires	8-46
snow tires	8-45
summer tires	8-45
tire chains	8-45
tire maintenance	8-38
tire replacement	8-37
tire rotation	8-35
tire sidewall labeling	8-38
tire terminology and definitions	8-42
tire traction	8-38
wheel alignment and tire balance	8-36
wheel replacement	8-38
<b>towing</b>	7-21
without wheel dollies	7-21
<b>trip computer mode</b>	4-78
<b>trip information (trip computer)</b>	
accumulated driving information mode	4-79
drive info display	4-80
trip modes	4-78
<b>trunk</b>	4-26
closing the trunk	4-27
emergency trunk safety release	4-27
opening the trunk	4-26
<b>turn by turn (TBT) mode</b>	4-70
<b>turn signal</b>	4-98

---

## U

<b>USB charger</b>	4-129
<b>USB port</b>	4-135
<b>user settings mode</b>	4-72

---

## V

<b>vehicle auto shut-off system</b>	5-43
<b>vehicle break-in process</b>	1-4
<b>vehicle certification label</b>	9-11

<b>vehicle data collection and event data recorders</b>	1-5
<b>vehicle identification number (VIN)</b>	9-11
<b>vehicle load limit</b>	5-62
<b>vehicle modifications</b>	1-4
<b>vehicle stability management (VSM) system</b>	5-40
<b>vehicle weight</b>	5-66

---

## W

<b>warning and indicator lights</b>	4-84
indicator lights	4-90
warning lights	4-84
<b>washer fluid</b>	8-25
checking the washer fluid level	8-25
<b>welcome system</b>	4-104
door handle lamp	4-104
headlight (headlamp)	
escort function	4-104
interior light	4-104
<b>windows</b>	4-32
power window lock button	4-35
window opening and closing	4-33
<b>windshield defrosting and defogging</b>	4-120
defogging inside windshield with automatic climate control	4-120
defogging logic	4-123
defroster	4-122
defrosting outside windshield with automatic climate control	4-121
front glass heater	4-122
<b>winter driving</b>	5-57
snow tires	5-57
snowy or icy conditions	5-57
tire chains	5-58
<b>wiper blades</b>	8-29
front windshield wiper blade	8-30
<b>wipers and washers</b>	4-102
operating windshield washers	4-103
<b>wireless smart phone charging system</b>	4-131

2023 KIA AMERICA, INC.



"Printed with soy-based ink on recycled paper. We support a healthy planet and better tomorrow."



Movement that inspires